

# OWNER'S MANUAL



## VF53BS VF63BS-R

PORTABLE  
FIRE PUMP

No.003-12099-3

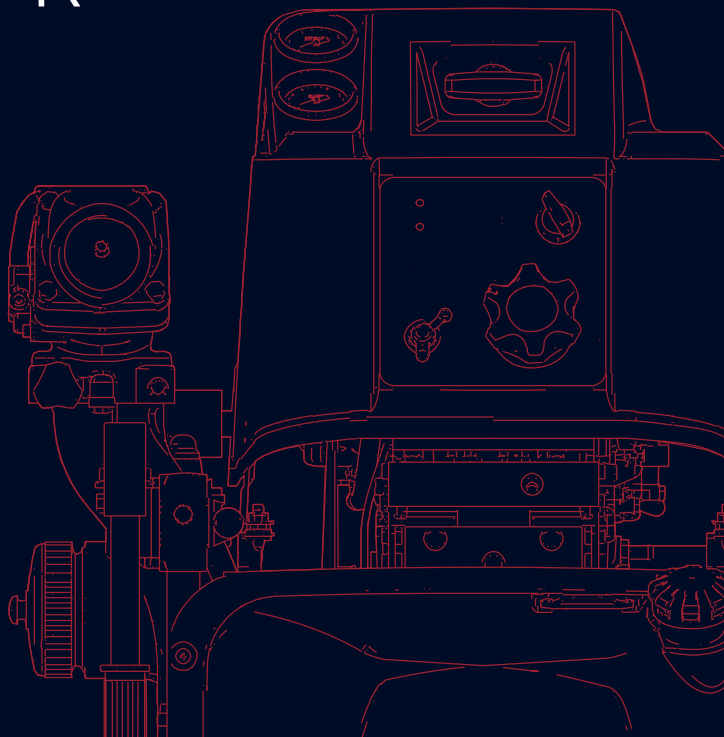

BACKS  
YOU  
UP™

Copyright © 2023 Tohatsu Corporation. All rights reserved. No part of this manual may be reported or transmitted in any form or by any means without the express written permission of Tohatsu Corporation.

---

## APPLICATIONS OF THIS FIRE PUMP

---

### **USAGE**

TOHATSU portable fire pump “VF53BS and VF63BS-R” are manufactured for use in firefighting operations.

The portable fire pumps are intended only for firefighting activities in collaboration with general public fire extinguishing equipment.

Using it for other applications is regarded as being used for improper purposes.

The manufacturer of the portable fire pump bears no responsibility for any damages that may result from modification of the fire pump without prior permission from the manufacture, improper use of the fire pump, or use of the portable fire pump for applications other than those stated above.

Note that use of the portable fire pump for applications other than those stated above can result in personal injury or damage to the equipment.

Using the portable fire pump within the range of intended uses implies that the user should follow the instructions provided by the manufacturer relevant to operation, servicing and maintenance.

## Intended people

All persons who operate, service or maintain the portable fire pump must read and understand the following items:

- Owner's manual
- Safety-related instructions on the pump and the other parts such as a battery.
- The other owner's manuals, such as a battery charger.

The portable fire pump should be operated by only persons who received training as operators of fire engines along with each country's (region's) regulations.

The range of personal responsibility and supervision must be strictly defined by the user.

If a person does not have adequate professional knowledge which is required for his/her assignment, he/she must undergo relevant training or receive appropriate instructions from an individual who is actually knowledgeable in operation of the fire pump.

A person who does not have enough knowledge is not permitted to operate the fire pump.

When using the portable fire pump, conditions under which an explosion may occur are not considered.



- **Keep the manual in a safe place for further reference.**
- **Operators of the portable fire pump must always refer to all the relevant manuals in order to avoid errors, personal injuries and equipment damages when operating the portable fire pump, and to maintain faultless operation.**
- **Place owner's manual so that operators can refer to it where they operate the fire pump.**

---

# INTRODUCTION

---

Thank you for purchasing the TOHATSU portable fire pump.

This portable fire pump has passed a range of quality assurance standards.

## Owner's manual

The portable fire pump complies with relevant laws and regulations.

The manual includes descriptions for operation and maintenance. Before using the portable fire pump, be sure to read and understand the manual thoroughly.

## Engine operation

The manual also includes descriptions for operation and maintenance of the engine.

|             |
|-------------|
| <b>NOTE</b> |
|-------------|

- The manual is an important item that goes with the portable fire pump.
- The manual should accompany the portable fire pump if sold to another person.

Before using the portable fire pump, write down the serial number in the following boxes. It will be useful in the case of asking about servicing, repairs and genuine parts.

## Serial Number

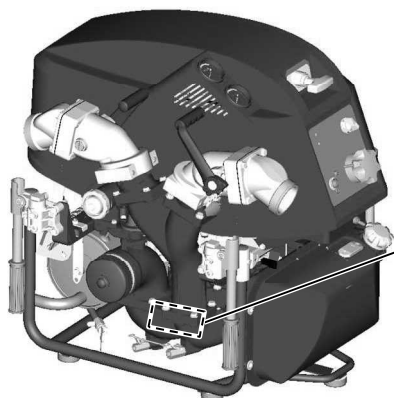

The pump serial (identification) number is marked on the adapter discharge valve.

|  |  |  |  |  |  |
|--|--|--|--|--|--|
|  |  |  |  |  |  |
|--|--|--|--|--|--|

## GENERAL SAFETY INFORMATION

### Overview

Before operating the TOHATSU portable fire pump thoroughly read the manual to understand the proper operating procedures including "DANGER", "WARNING", "CAUTION" and "NOTE".

These notices are designed to bring attention to very important information necessary to ensure safe, trouble-free operation.

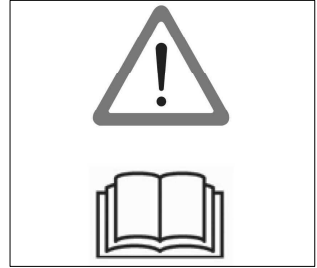

### Warning sign

#### Meaning

This sign is used for safety-related instructions in this manual.

Be sure to follow all safety-related instructions, otherwise personal injury may occur.



### Signal words



**DANGER**

- Failure to observe will result in severe personal injury or death, and possibly property damage.



**WARNING**

- Failure to observe could result in severe personal injury or death.

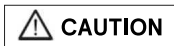

**CAUTION**

- Failure to observe could result in personal injury or property damage.

- The instruction provides special information to facilitate the use or maintenance of the portable fire pump or to clarify important points.
- For attaching position of the warning label, refer to the contents "3. LABELS".
- **Warning labels should be read clearly at any time.**

**If the display of the warning label may become difficult to read, it must be replaced immediately.**

### Safety-related instructions and warning signs

Read and follow the safety-related instructions described in the manual and all warning signs on the portable fire pump thoroughly.

Always keep the warning signs in a legible condition. If any warning sign becomes illegible or detached, replace it immediately.

## Transporting the portable fire pump

### CAUTION

- Retractable handle is folding type. Do not put a hand or finger between top of the retractable handle and bracket.
- When transporting the portable fire pump, assign one person per handle.
- Also, transporting the portable fire pump, it should be transported holding the handle firmly. There is a risk of injury to the leg by fall.



## Durability of protection

Purchasing a new portable fire pump, it is placed in a packing box and protected.

## Storage of pump after transportation

Keep the pump away from high humidity, and place it on level ground.

## Disposal of packing box

Dispose the packing box by following the environmental laws.

## Emissions

### Noise emission

### CAUTION

- Wear proper hearing protection during operation.



## Exhaust gas

Fatal hazard from carbon monoxide (CO) poisoning

Exhaust gas emitted from engines contains carbon monoxide (CO) and other gases that have serious effects on the human body.

Do not operate the engine in a room, car, warehouse, tunnel or other closed locations that have poor ventilation.



## Safety devices

Before operating the portable fire pump, be sure to check that all the safety devices have been installed in the appropriate positions.

Before removing the safety devices, turn the main switch off.



After protection devices (such as muffler guard) have been disassembled during servicing or maintenance work, install them back as soon as possible to their original positions, and make sure that they are in safe secure condition.



Check the portable fire pump visually and functionally on a regular basis.

If you find any faulty devices or equipment, remove it immediately, and repair or replace it, if necessary.

Failure to do so may cause an accident.

After it has been repaired or replaced, make sure that it functions correctly.

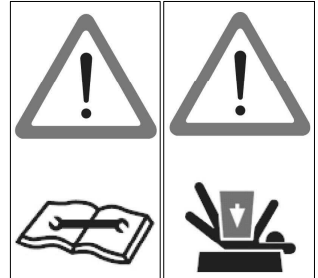

## Protective clothing and Protective equipment

During fire extinguishing training or regular firefighting services, wear normal protective clothing and equipment to protect your body.

- Fire protective clothing
- Fireproof helmet
- Fireproof protective gloves
- Fireproof protective boots





## Service and Maintenance

Servicing and maintenance of the portable fire pump must be carried out by only the persons who have professional knowledge, who are familiar with the device, and who understand laws and regulations regarding safety and accident prevention.

Before starting maintenance work, turn the main switch off to stop the engine.

Disconnect the negative terminal of the battery.

Before starting maintenance work, securely place the portable fire pump on the ground.

Do not touch the exhaust pipe, the muffler and the other engine parts until these parts will be cold enough. These parts could be very hot and will cause severe burns.



## Electrical equipment

Only expert electricians or trained staff members should handle electrical equipment.

When removing the battery cable from the electrical equipment, always disconnect the negative (-) cable first.

When connecting the cable to the battery, be sure to connect the positive (+) cable first. After that, connect the negative (-) cable next.

Do not place any metal on the top of or around the battery. Doing so may cause a short circuit.

Use a fuse with the same specifications as the original one when replacing it. Using a fuse that has a greater capacity than the rated value may damage the equipment.

While the engine is running, do not touch the high voltage ignition wire attached to spark plug. This wire carries very high voltage which will cause injury and bodily harm.

Check the electrical equipment of the portable fire pump on a regular basis.

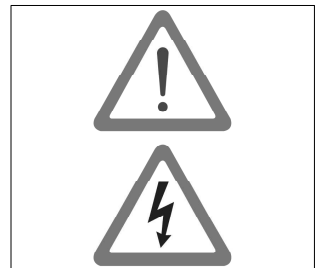
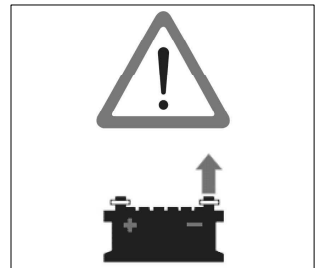

## Battery

Follow any safety-related instructions shown on the battery.

The battery can generate flammable hydrogen gas that may **cause an explosion**.

Do not charge the battery in closed location.

Do not smoke around the battery.

The battery electrolyte is **caustic and may cause personal injuries**.

- Always wear protective clothing.
- Always wear protective gloves.
- Always wear protective glasses.
- Do not tilt the battery. Doing so may cause the battery electrolyte to leak out from the vent hole.



## Disposal

Dispose the disused batteries according to relevant laws and regulations.

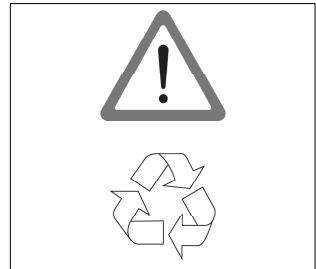

## Handling of fuel

Exercise care when handling fuel. Failure to do so may cause fire.

Do not bring any flames near fuel. Stop the engine before refilling fuel. Do not smoke while refilling fuel.

Do not refill fuel in an enclosed room to avoid an explosion by fuel fumes.

If fuel spills, wipe it with a cloth or other material, and dispose it according to relevant laws and regulations.



## Genuine parts

When replacing parts for servicing and maintenance of portable fire pumps, be sure to use only Tohatsu genuine parts.

If genuine Tohatsu parts and accessories are not used, it may adversely affect the functioning and safety of the portable fire pump. Use genuine Tohatsu parts only.

Tohatsu bears no responsibility for any personal injuries or equipment damage that may result from use of parts or accessories obtained from outside sources.

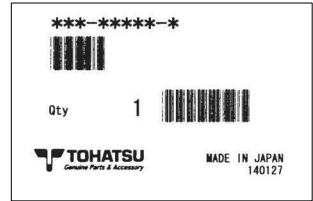

## Environmental protection measures

Dispose of oil, fuel, batteries, etc. according to relevant environmental laws.

Do not dump waste into the ground, water, or sewerage.

Store the fuel only in the specified container.

When disposing of parts, follow the correct disposal procedure.

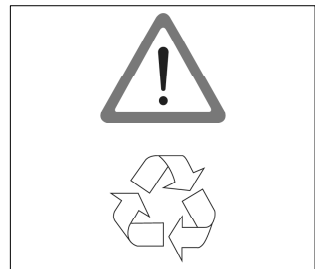

## Water-prohibiting substance

Do not discharge water to water-prohibited substance.

## Use of water

Do not pump combustible liquids, chemical or caustic liquids.

---

# CONTENTS

---

|   |    |
|---|----|
| 1. SPECIFICATIONS .....                 | 1  |
| 2. OPERATION DEVICE .....               | 4  |
| 3. LABELS .....                         | 7  |
| 4. OPERATING PRECAUTIONS .....          | 8  |
| 5. DESCRIPTION OF DEVICES .....         | 10 |
| 6. PREPARATION FOR OPERATION .....      | 21 |
| 7. USE OF CONTROL PANEL .....           | 24 |
| 8. STARTING THE ENGINE .....            | 33 |
| 9. PRIME AND DISCHARGE .....            | 37 |
| 10. STOPPING THE ENGINE .....           | 47 |
| 11. MAINTENANCE AFTER OPERATION .....   | 48 |
| 12. MAINTENANCE IN COLD CONDITION ..... | 54 |
| 13. USE OF ACCESSORY .....              | 57 |
| 14. PERIODICAL INSPECTION .....         | 59 |
| 15. SERVICE AND MAINTENANCE .....       | 61 |
| 16. TROUBLESHOOTING .....               | 72 |
| 17. APPENDIX .....                      | 78 |
| 18. TOOL AND STANDARD ACCESSORY .....   | 79 |

# 1. SPECIFICATIONS

| Model                       | VF53BS  | VF63BS-R  |
|-----------------------------|---|---|
| Description                 | Portable fire pump  |   |
| Max. operating pressure     | 1.24 MPa (179.8 psi)  |   |
| Usable ambient temperatures | -20 °C ~40 °C (-4°F~104°F)  |   |
| <b>Engine</b>               |   |   |
| Manufacturer                | TOHATSU CORPORATION   |   |
| Model                       | 3WF61B  |   |
| Type                        | 4-stroke, 3-cylinder, water cooled gasoline engine                                  |   |
| Bore × Stroke               | 61 × 57 mm (2.40 x 2.24 inch)   |   |
| Piston displacement         | 500 ml (30.5 cu.in.)  |   |
| Authorized output           | 22 kW / 6200 r/min  |   |
| Fuel type                   | Unleaded Gasoline (RON 91 or Higher)  |   |
| Fuel tank capacity          | 10 L (2.7 USG)  |   |
| Fuel consumption            | Approx. 8.5 L/hr (2.25 USG/hr)<br>at 0.55 MPa 1130 L/min<br>(at 79.8 psi 298.5 GPM) | Approx. 9 L/hr (2.38 USG/hr)<br>at 0.7 MPa 1000 L/min<br>(at 101.5 psi 264.2 GPM) |
| Engine oil                  | API: SH, SJ, SL SAE: 10W-30/40  |   |
| Engine oil quantity         | 1.6 L (1.7 US qt.)<br>(When replacing oil filter:1.7 L (1.8 US qt.)                 |   |
| Ignition                    | Flywheel magneto (DIGITAL C.D.I. system)  |   |
| Spark plug                  | NGK DCPR6E  |   |
| Starting system             | Electric starter and recoil   |   |
| Lubrication                 | Wet sump  |   |
| Fuel feed system            | Electronic fuel injection   |   |
| Battery *                   | Capacity  | 12-18Ah/10HR (226CCA)   |
|                             | Dimensions<br>(L x W x H)   | 150 x 87 x 161 mm (5.91 x 3.43 x 6.34 inch)                                       |
|                             | Positive terminal   | Right side  |

\* The battery is not shipped with the pump. Install a battery equivalent to this specification.

# 1. SPECIFICATIONS

| Model                                     | VF53BS  | VF63BS-R       |                  |
|---|---|----------------|------------------|
| <b>Primer</b>                             |   |                |                  |
| Type                                      | Rotary-vane vacuum pump (Oil less type)   |                |                  |
| Max. suction height                       | Approx. 9 m (29.5 ft.)  |                |                  |
| <b>Pump</b>                               |   |                |                  |
| Type                                      | Single suction, single stage, high pressure turbine pump  |                |                  |
| Transmission Ratio                        | 1 : 1   |                |                  |
| Number of delivery outlet                 | 2   |                |                  |
| Discharge port coupling                   | JIS 65 mm (2-1/2") male<br>NH 2-1/2" (65 mm) male   |                |                  |
| Suction port coupling                     | JIS 75 mm (3") male<br>NH 4" (100 mm) male  |                |                  |
| Pump performance<br>(Suction height: 3 m) | 1200 L/min at 0.6 MPa   |                |                  |
|   | 950 L/min at 0.8 MPa  |                |                  |
|   | 700 L/min at 1.0 MPa  |                |                  |
|   | 340 GPM at 75 psi   |                |                  |
|   | 290 GPM at 100 psi  |                |                  |
| <b>Dimensions and weight</b>              |   |                |                  |
| Overall Length x Width x Height           | 670x780x740 mm (26.38x30.71x29.13 inch.)<br>635x780x740 mm (25.00x30.71x29.13 inch.) ~North America |                |                  |
| Mass                                      | Dry   | 84kg (185 lbs) | 84.5kg (186 lbs) |
|   | Ready for operation   | 99kg (218 lbs) | 99.5kg (219 lbs) |

## Materials

| <b>Engine</b>                      |  |
|------------------------------------|--|
| Crankcase, Cylinder, Cylinder head | Aluminum alloy                               |
| Crankshaft                         | Chromium-molybdenum steel                    |
| Connecting rod                     | Aluminum alloy                               |
| Piston                             | Aluminum alloy                               |
| Pump shaft                         | Chromium-molybdenum steel with metal plating |
| Muffler                            | Stainless / Steel                            |
| <b>Pump</b>                        |  |
| Pump casing, Pump cover            | Aluminum alloy                               |
| Impeller                           | Aluminum alloy                               |
| <b>Shaft seal</b>                  |  |
| Type                               | Mechanical seal                              |

# 1. SPECIFICATIONS

## Performance Curve VF53BS, VF63BS-R

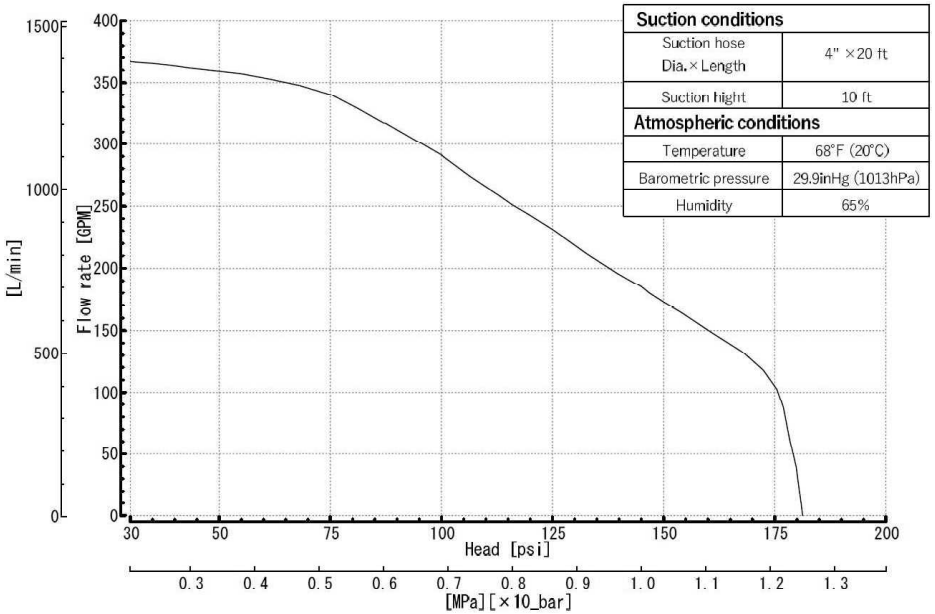
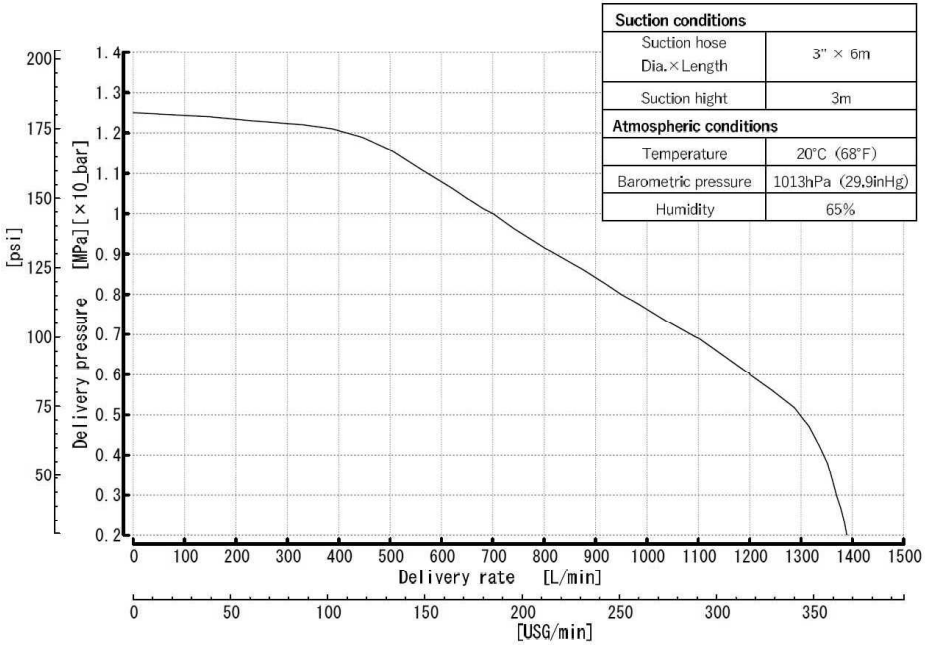

---

## 2. OPERATION DEVICE

---

### VF53BS

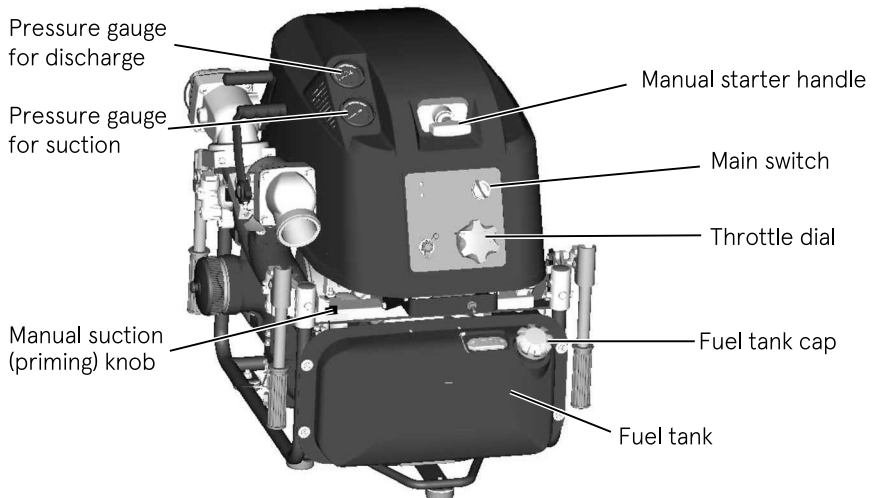
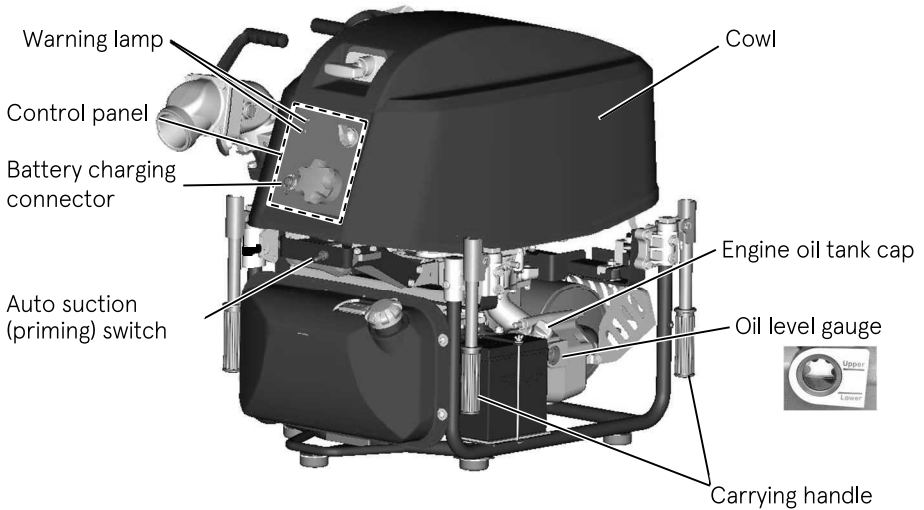



---

## 2. OPERATION DEVICE

---

VF53BS

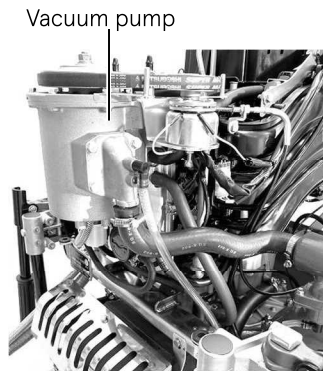
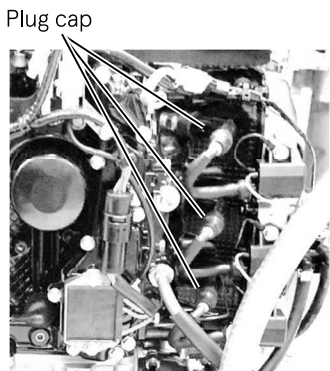
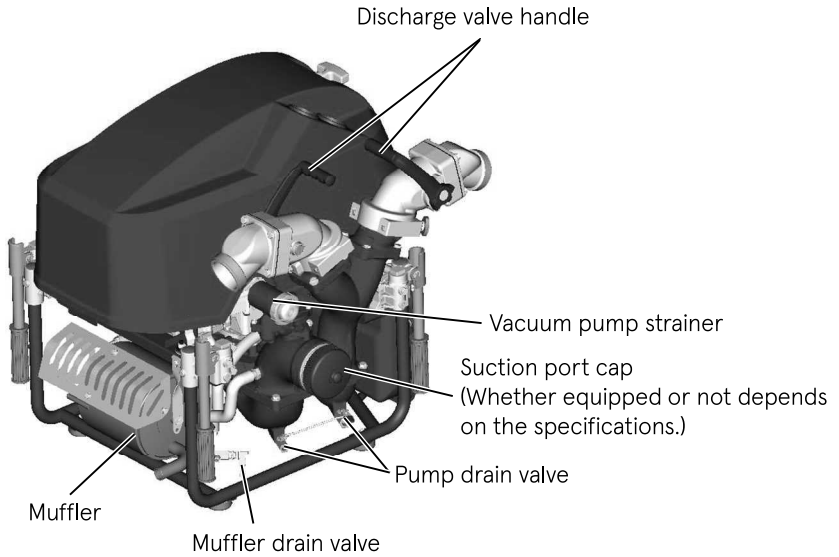

---

## 2. OPERATION DEVICE

---

VF63BS-R

Different operation part from VF53BS

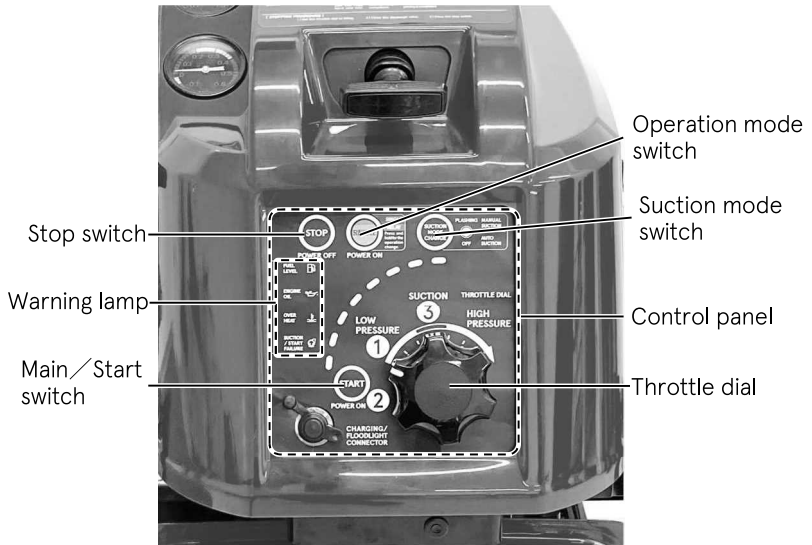

---

## 3. LABELS

---

CAUTION, WARNING, DANGER

Danger: Flammable and explosive

Warning: Fuel, Oil

Caution: Exhaust gas, Noise

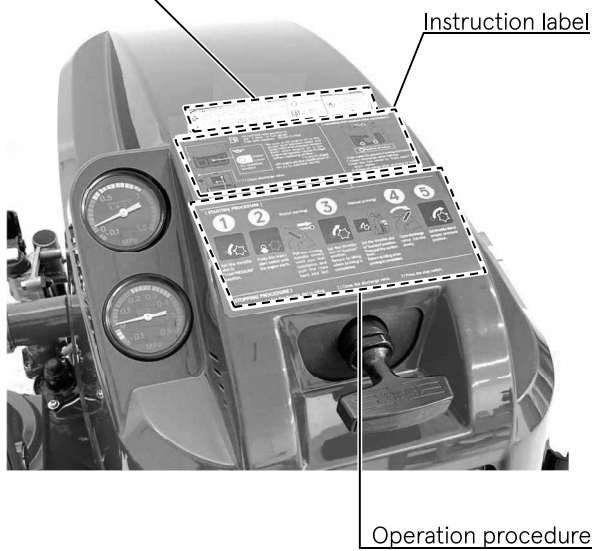

---

## 4. OPERATING PRECAUTIONS

---

### Installing pump

 CAUTION

- The fire pump must be installed on level ground. Otherwise, an accident may occur.
- If the fire pump should be installed on uneven ground, it must be secured.
- When installing the portable pump in a vehicle, place the vehicle on level ground, and install the pump.
- When installing the portable pump in a vehicle, make sure to apply the brakes of the vehicle in order to stop the wheels. A serious accident may occur if the vehicle moves.
- Do not put your hands or fingers in the retractable part when using the handle.
- When transporting the portable fire pump, assign one person per handle. Also, when you transport the portable fire pump, it should be transported holding the handle firmly on each to avoid falling down the pump.
- Do not touch the exhaust pipe and the muffler while the engine is running, or for more than 10 minutes after the engine has been stopped. These parts are very hot and will cause severe burns.

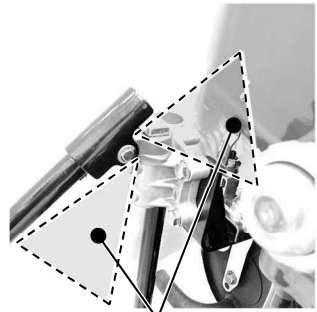

Do not put your hands or fingers

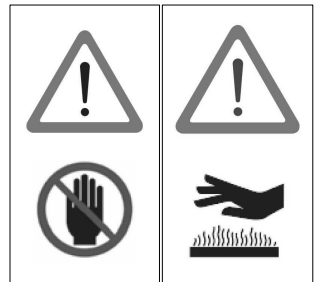

---

## 4. OPERATING PRECAUTIONS

---

|             |
|-------------|
| <b>NOTE</b> |
|-------------|

- Place the pump as near as possible to water source, and water suction height as low as possible.
- When placing the portable fire pump on the ground, place it slowly and horizontally.
- In case of the inclined location or uneven ground, make sure that water suction hose is lower than suction port of the pump.
- In case of the suction hose is put undulated, air can be left easily in the hose, and possibly cause suction inability when the water discharge valve is opened.
- In case of the suction inability due to air remaining in the suction hose, set the water discharge valve half-opened, and operate vacuum pump until water is discharged continuously. (More operation of vacuum pump for 3 to 5 seconds from beginning of water discharge.)
- Be sure to install strainer and basket at the end of suction hose. If the pump may suck sand or mud from the water source bottom, place sheet below the basket.
- Strainer and basket of suction hose should be placed more than 30 cm below water surface to prevent suck of air.
- Discharge hose should be arranged not to be bent.

---

## 5. DESCRIPTION OF DEVICES

---

### Carrying handle

The fire pump is equipped with four carrying handles. The handles can be manually folded, and turned 90 degrees to open it.

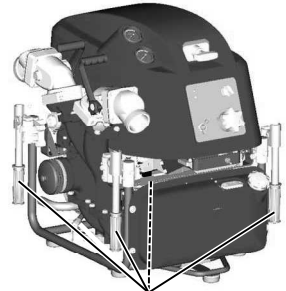

Carrying handle



- **Personal injuries may occur when opening or closing the handle.**
- **Do not put your hands or fingers into the retractable part when operating the handle.**
- **To prevent injury, two people or more should carry and install the pump.**



### Removing cowl

1. First lift the hooks on the back, then lift the hooks on the front while avoiding interference with the starter handle and the water discharge valve(s).

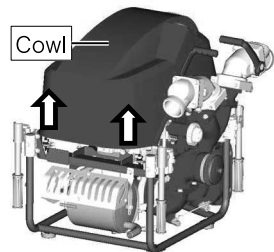

Cowl

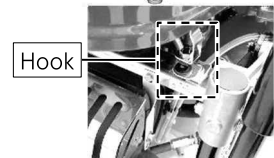

Hook

2. Remove the cowl by lifting the front and rear of the cowl.

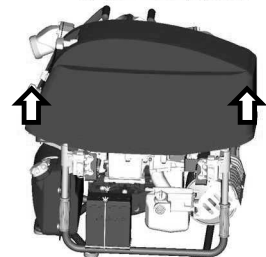

---

## 5. DESCRIPTION OF DEVICES

---

### Installing cowl

Installing order is in reverse order of the removing.

**NOTE**

- Pay attention to have the starter handle for manual starting go through the window at the front-upper side.



### Suction port

The diameter of the thread for the fire pump is JIS 75 mm or NH 4".

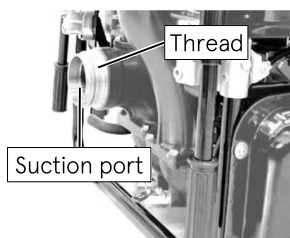
**WARNING**

- Putting a finger or a hand into the suction port while the pump is running without installing the strainer, it may be seriously damaged by the rotating inducer.

**CAUTION**

- A strainer must be installed at the suction port.
- Do not run the pump if the strainer is not installed. If the pump is running without the strainer, gravel may enter the pump and causes significantly reduced water discharge capacity.



---

## 5. DESCRIPTION OF DEVICES

---

### Discharge port

The diameter of the thread for fire pump,

JIS 65 mm

NH 2-1/2"

### Discharge valve

Use discharge valve handle for opening and closing the discharge valves.

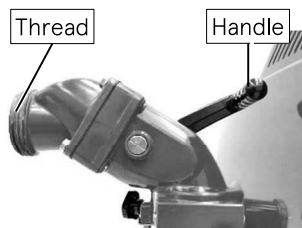

### Drain valve

Use the drain valves to drain water from the pump.

Drain valves:

- Pump case
- Muffler

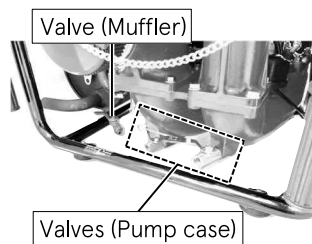



---

## 5. DESCRIPTION OF DEVICES

---

### Manual suction knob

- Use for sucking (priming) water by manual operation.
- After starting the engine, pull the manual suction knob to suck up water.
- After sucking up water has been completed, return the manual suction knob to its original position.

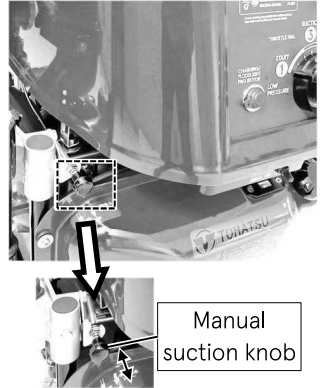

### Fuel tank

- Refill appropriate amount of gasoline to the fuel tank.
- Close the fuel tank cap all the time except refuel.



### Engine oil

Before using the pump, fill it with the designated amount of 4-stroke engine oil.

Fill the engine oil until "Upper" level.

#### NOTE

- Fill the 4-stroke engine oil.

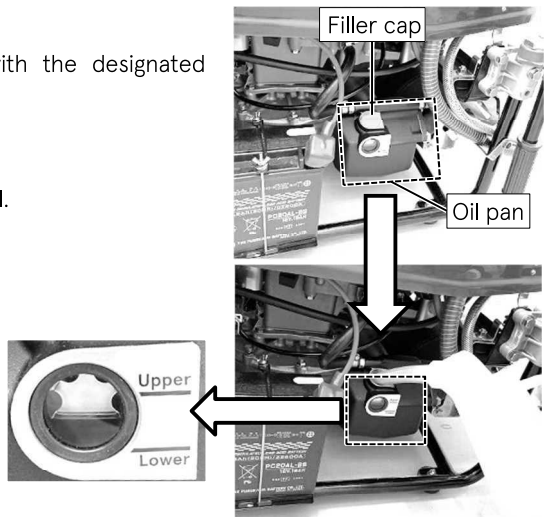

## 5. DESCRIPTION OF DEVICES

### Control panel

The control panel is equipped with all the necessary operation and control instruments as follows.

- Mainswitch
- Stop switch (VF63BS-R)
- Throttle dial
- Warning lamp
- Auto suction switch (VF53BS)
- Operation mode switch (VF63BS-R)
- Suction mode switch (VF63BS-R)
- Connector for charging battery

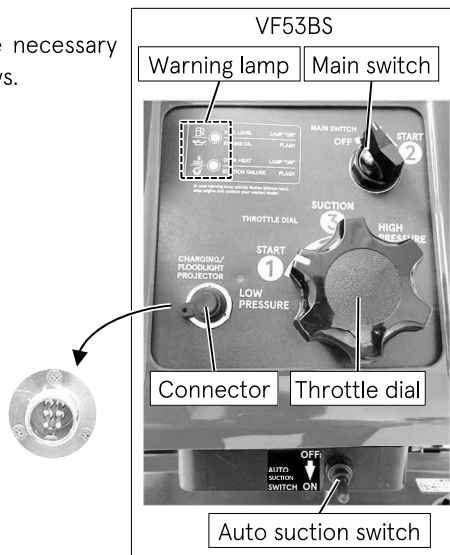

### Warning lamp & buzzer

Turning on the main switch, the lamp and buzzer check mode starts.

The warning lamps turn on and the warning buzzer sounds for a moment while the check mode operates. If the lamp and buzzer check mode would show failure, refer to “Chapter 16 TROUBLESHOOTING” to eliminate the cause.



- **Remove the cause of failure following “Chapter 16 TROUBLESHOOTING”.**

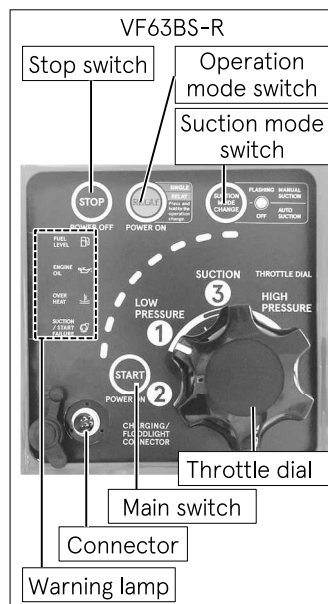

## 5. DESCRIPTION OF DEVICES

The monitor indicates the following information.

- Fuel level warning
- Engine oil pressure warning
- Overheating warning
- Suction failure warning

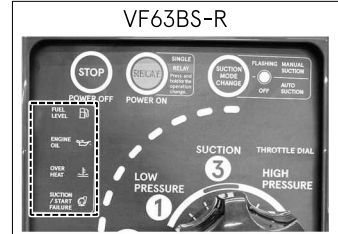
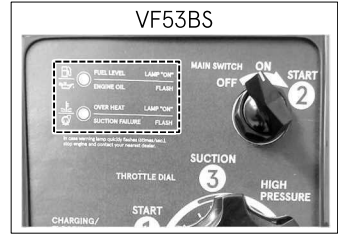

### Fuel and Engine oil warning

If the fuel level in the fuel tank is below approximately 1/3, the warning lamp turns on and the warning buzzer sounds when the main switch is turned on.

If the oil pressure drops during operation, the warning buzzer sounds,

VF53BS: The warning lamp flashes.

VF63BS-R: The warning lamp turns on.

If the oil pressure switch is defective or the circuit is disconnected, the warning lamp flashes when the main switch is turned on.



- **If the lamp flashes or turns on, take countermeasures following “Chapter 16 TROUBLESHOOTING”.**

**NOTE**

- The lamps turn on and warning buzzer sounds instantaneously when the main switch is turned on, which is normal operation. The lamps turning on instantaneously show the system check operation has done.

## 5. DESCRIPTION OF DEVICES

### Engine overheating and Suction failure

If the engine stops due to insufficient cooling water, the warning lamp turns on and the warning buzzer sounds.

If the engine stops due to suction failure within 30 seconds in the auto priming mode, the warning buzzer sounds,

VF53BS: The warning lamp flashes.

VF63BS-R: The warning lamp turns on.

If the TPS, MAT, MAP or ETS is defective, or the circuit is disconnected, the warning lamp flashes fast and the buzzer sounds intermittently when the main switch is turned on.



- The engine may be damaged.
- Do not restart the engine soon after it has stopped running.
- Take countermeasures first following “Chapter 16 TROUBLESHOOTING”.

### NOTE

- The engine stops automatically when overheating is detected.

### Main switch

VF53BS

Main switch position and function

| Position | Function                |
|----------|-------------------------|
| OFF      | To stop the engine      |
| ON       | Engine running position |
| Start    | To start the engine     |

VF63BS-R

Main switch situation and function

Press the main switch to run the pump.

| Situation      | Function                      |
|----------------|-------------------------------|
| Light off      | Stop running                  |
| Light flashing | Ready to start                |
| Light on       | Starting the pump, or running |

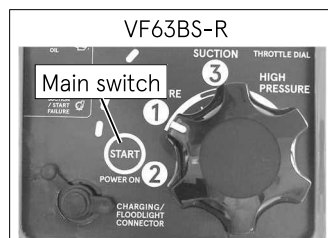
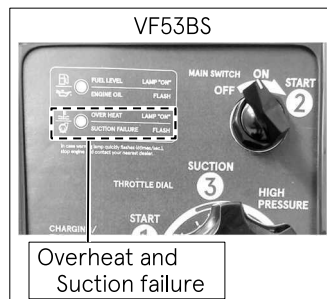

## 5. DESCRIPTION OF DEVICES

### Auto water suction

#### Auto suction switch (VF53BS)

In the case of turning on the auto suction switch, running the engine, and turning the throttle dial to suction position, the pump starts to suck water.

#### Suction mode switch (VF63BS-R)

Turn the suction mode switch lamp to the off state. (Press the suction mode switch if necessary.) Start the engine and turn the throttle dial to suction position, and then the pump starts to suck up water automatically.

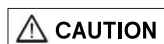

- Do not manual operation of pulling the manual suction knob when the auto suction switch is on.

Manual suction knob

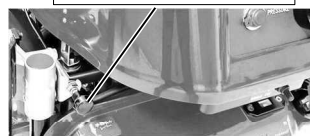

### Pressure gauge for discharge

The pressure gauge for discharge indicates the actual operating water pressure.

Pressure gauge for discharge

Pressure gauge for suction



### Pressure gauge for suction

The pressure gauge for suction indicates the suction side water pressure and the input pressure supplied from an external water source.

---

## 5. DESCRIPTION OF DEVICES

---

### **Water recirculation system**

This system is to recirculate the cooling water without draining outside.

Accordingly, the engine does not have a cooling water drain hose.

### **Overheat prevention device**

This device monitors the engine temperature with an engine block temperature sensor. When the engine block temperature rises over the setting temperature (approximately 80° C), buzzer alarms, and the engine block temperature rises over the temperature (approximately 90°C ) or higher, buzzer alarms continuously and automatically the engine stops to prevent overheating.

- Situation of the warning lamp after the overheat prevention device is actuated.
  - ✓ Once the power is turned off, the engine is started, and if the temperature exceeds 80°C, the overheat protection device including the advance warning will be actuated.
- Precautions for restarting after the overheat prevention device is actuated.
  - ✓ Resolve the cause of the abnormally high engine temperature, and then restart the engine. If the cause of the abnormally high engine temperature has not been resolved, the engine will stop again within approximately 30 seconds. (The time in seconds until the engine stop varies depending on the temperature of the engine block.)
  - ✓ The starter motor will operate even if the engine block temperature exceeds about 120°C, but the engine prevention function is actuated, and the pump cannot be restarted.

|             |
|-------------|
| <b>NOTE</b> |
|-------------|

- Do not repeatedly restart the engine without resolving the cause of the abnormally high engine block temperature.

### **Electric Safety Governor (ESG)**

The electric governor controls the maximum engine speed by cutting off ignition so that the engine speed does not exceed 6200 r/min.

### **Battery save control**

If the engine power is turned on and not started within 30 minutes, the power automatically turns off.

## 5. DESCRIPTION OF DEVICES

### Installing battery

Install the battery in the pump. Secure the battery with the battery terminals facing outward.



- Refer to the contents "13. USE OF ACCESSORY Battery".
- Refer to the instruction of the battery.

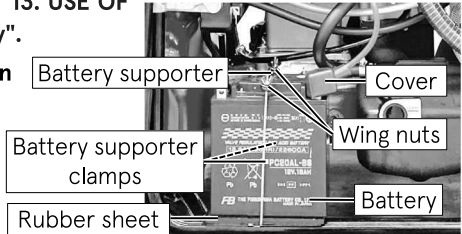

### Initial charge of battery

The battery can be used immediately after filling cells with electrolyte. However, it is also recommended to charge the battery after filling the cell with electrolyte before using it.

\_Sealed type /Maintenance free battery\_

Be sure not to open the battery after filling it with electrolyte.

### Battery charger connector

Used to charge the pump battery.

<Specifications of accessory connector>

- Voltage: DC12V
- Max. allowable current: 5A



- Before charging the battery, turn off the main switch.
- When starting operation, be sure to remove the battery charger before turning on the main switch.
- The connector is for a battery.
- Do not connect anything other than the specified battery charger to the battery charging connector.

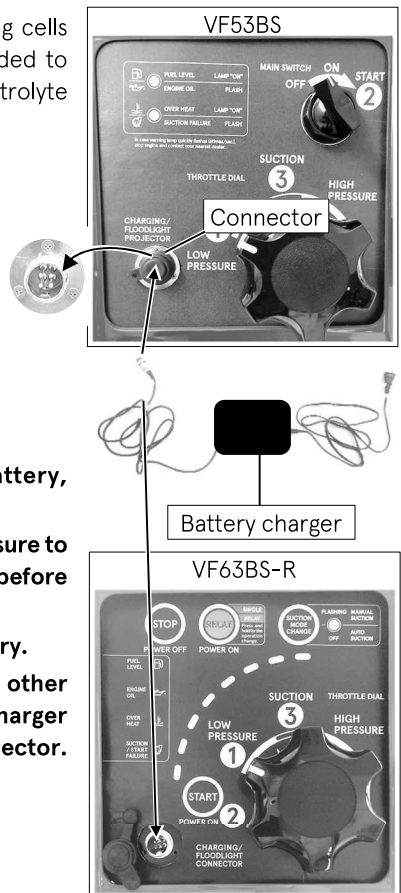

---

## 5. DESCRIPTION OF DEVICES

---

### Fuse box

Security fuses are installed for electrical circuit in the fuse boxes.

There are two fuse boxes:

- Black color fuse box: 15A fuse.
- Yellow color fuse box: 7.5A fuse.

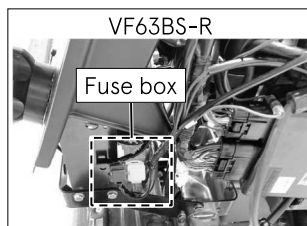
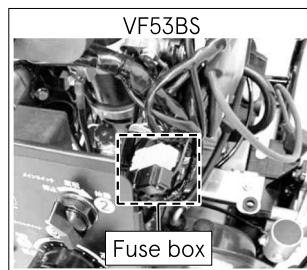

### Manual starter

If the engine does not start with the electric starter motor, use the manual starter.



- **Do not pull the manual starter handle when the pump is running. Personal injuries may occur, and the manual starter may be damaged.**

### NOTE

- To start the engine with manual starter, engage the manual starter ratchet by pulling the starter rope slowly. And then pull the starter handle quickly with great force from the position in which feeling harder resistance.





## 6. PREPARATION FOR OPERATION

### Fuel

Fill the tank with gasoline until the maximum level of the (red) gauge indication.

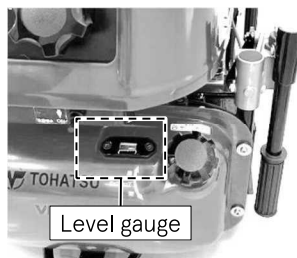

#### DANGER

- Vaporized fuel may cause ignition or an explosion.
- Keep the flame away from fuel.
- Stop the engine before refueling.
- Do not spill fuel.
- Do not overfill the tank with fuel.



#### CAUTION

- Do not inhale the fumes! Gasoline fumes are very toxic!
- After stopping the engine, do not touch it while it is hot.
- Refuel after the engine has cooled down.
- Close the fuel tank cap tightly.
- Remove the fuel tank cap only when refueling or when inspecting the inside of the fuel tank.
- Clean out all spilled fuel properly (checking for gasoline vapor) before starting engine.
- If fuel is spilled, wipe it off with a cloth and dispose of it according to the law.

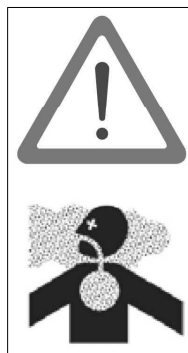

## 6. PREPARATION FOR OPERATION

### NOTE

- Using low quality fuel will shorten the life of the engine and cause engine problems such as difficulty in starting.
- Fuels containing alcohol, methanol (methyl), or ethanol (ethyl) may cause the following.
  - Deterioration of rubber and plastic parts.
  - Starting, idling, or other engine performance problems.
- Do not use fuel containing over 10% ethanol. Do not use fuel containing over 5% methanol.
- Damages resulting from the use of fuel that contain alcohol are not covered under the limited warranty.
- Always fill the fuel tank with gasoline to be ready.

### Engine oil

Before using the pump, fill it with the designated amount.

Fill the engine oil until upper level.

1. Check the engine oil level before starting the engine.
2. To check the engine oil level correctly, leave the engine stopped for at least 24 hours. Then, check the oil level.
3. Refill the oil pan with the appropriate amount of oil.
4. Always close the oil tank filler cap except for refilling.

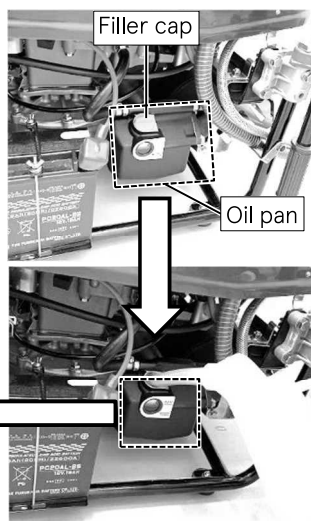
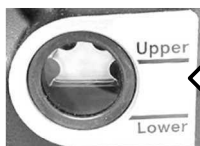

### ⚠ CAUTION

- **Fill with 4-stroke engine oil.**

### NOTE

- Check the engine oil level before starting the engine. To check the engine oil level correctly, leave the engine stopped for at least 24 hours. Then check the oil level.
- If the oil becomes cloudy white or dirty, please contact your local service representative.

---

## 6. PREPARATION FOR OPERATION

---

### 4-stroke engine oil

Use the engine oil shown below (classification),

API: SH, SJ, SL

SAE: 10W-30/40

### Drain valve

Make sure to close all the drain valves.

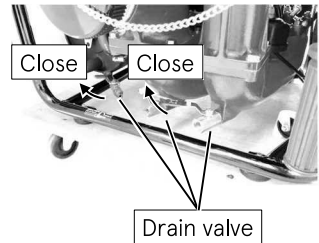

### Discharge valve

Close the discharge valves.

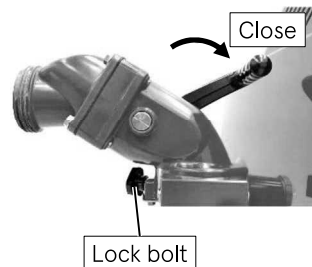

#### NOTE

- The direction of the valve can be locked by tightening the lock bolt.
- Do not change the direction of the discharge valve if the lock bolt is tightened.

## 7. USE OF CONTROL PANEL

### Control Panel

#### VF53BS

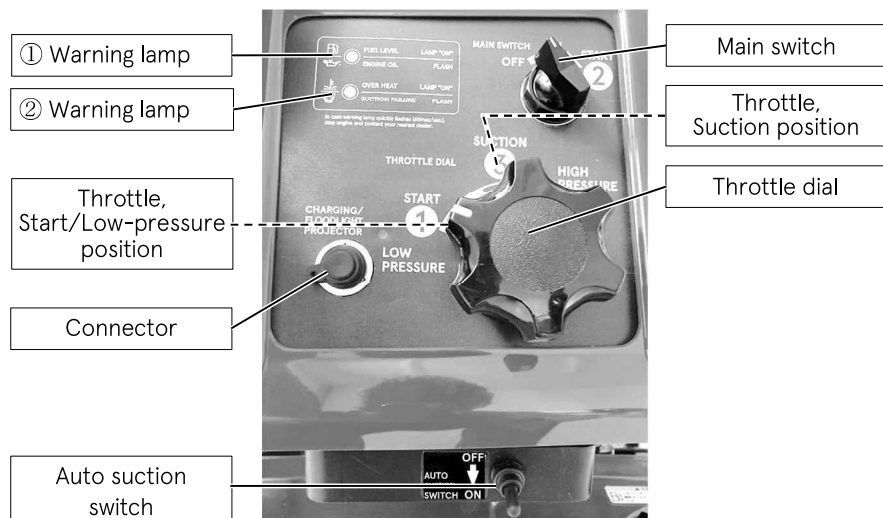

#### VF63BS-R

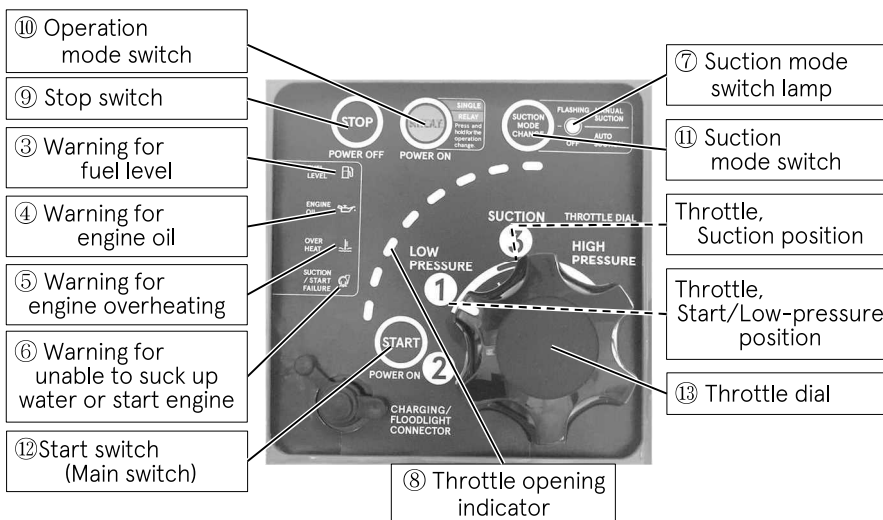

## 7. USE OF CONTROL PANEL

### Warning lamp

#### VF53BS

|   |              |  |
|---|--------------|--|
| ① | Warning lamp | Light on: Fuel shortage.<br>Flashing: Engine oil pressure reduced.<br>Failed oil pressure switch or broken circuit.  |
| ② | Warning lamp | Light on: Engine stop due to overheating.<br>Flashing: Unable to suck up water. (Water suction is not completed within 30 seconds in automatic water suction mode.)<br>Fast flashing: Failure of TPS, MAT, MAP, ETS or broken circuit. |







#### VF63BS-R

|   |   |  |
|---|---|--|
| ③ | Warning for refueling                               | Light on: Fuel shortage. (Fuel level is below approximately 1/3 of fuel tank.)   |
| ④ | Warning for engine oil pressure                     | Light on: Low oil pressure during engine running.<br>Flashing: Oil pressure switch failure.  |
| ⑤ | Warning for engine overheating                      | Light on: Prevention device has been actuated.<br>Flashing: Pre-warning of overheating.<br>Fast flashing: Sensor failure, poor connection. See pictogram section.  |
| ⑥ | Warning for unable to suck up water or start engine | Light on: Unable to suck up water. (Water suction is not completed within 30 seconds in automatic water suction mode.) During automatic relay operation, the engine fails to start even after repeating the start pattern 6 times.<br>Fast flashing: Sensor failure, poor connection. See pictogram section. |
| ⑦ | Suction mode switching lamp                         | Indication for chosen water suction mode.<br>Light off: Auto<br>Flashing: Manual   |
| ⑧ | Throttle opening indicator                          | Throttle opening level. (8 steps)  |
| ⑨ | Stop switch   | Stop the engine. / Power off.  |
| ⑩ | Operation mode switch                               | Press the switch once: Power on.<br>Keep pressing the switch down: Switching of operation mode. ~Single (Stand-alone) / Relay pump   |
| ⑪ | Suction mode switch                                 | Switching of water suction operating mode.<br>~Auto / Manual   |
| ⑫ | Start switch (Main switch)                          | Power on / Start the engine with starter.  |
| ⑬ | Throttle Dial                                       | Throttle open/close (Manual)   |

## 7. USE OF CONTROL PANEL

### Pictogram

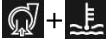
The warning is also notified by the light of the pictogram. (VF63BS-R)

|   |   |
|---|---|
|    | <ul style="list-style-type: none"> <li>■ Fuel shortage<br/>Light on: Amount of fuel in the fuel tank is 1/3 or less. <ul style="list-style-type: none"> <li>• Refuel.</li> </ul> </li> </ul>  |
|    | <ul style="list-style-type: none"> <li>■ Low oil pressure<br/>Light on: Engine oil pressure reduced during engine running. <ul style="list-style-type: none"> <li>• Check the quantity of engine oil and refill the oil. If the oil level is in the specified level. Contact the dealer.</li> </ul> </li> <li>■ Oil pressure switch failure<br/>Flashing: It is diagnosed that the oil pressure is increasing even though the engine is not started. Contact the dealer.</li> </ul>   |
|    | <ul style="list-style-type: none"> <li>■ Overheating<br/>Flashing: Pre-warning of overheating<br/>Light on: Overheat prevention device actuates. <ul style="list-style-type: none"> <li>• Eliminate the cause of overheating. Then after, start the engine again.</li> </ul> </li> </ul>  |
|    | <ul style="list-style-type: none"> <li>■ Unable to suck up water completely<br/>Light on: Sucking water is not completed within 30 seconds. <ul style="list-style-type: none"> <li>• Refer to " Chapter16 TROUBLESHOOTING". Eliminate the cause of failure. Then after, start the engine again.</li> </ul> </li> <li>■ Inability of starting<br/>Light on: In automatic relay pump operation mode, the engine fails to start even after repeating the start pattern 6 times. <ul style="list-style-type: none"> <li>• Eliminate the cause of starting inability. Then after, start the engine again.</li> </ul> </li> </ul> |
|  | <ul style="list-style-type: none"> <li>■ Sensor failure<br/>Fast flashing: Any of the MAT, MAP, or ETS are disconnected or failed.<br/>Contact the dealer.</li> </ul>   |
|  | <ul style="list-style-type: none"> <li>■ Sensor failure<br/>Fast flashing / Throttle opening indicator lamps flash alternately*: TPS sensor is disconnected or failure. Contact the dealer.</li> </ul>  |
|  | <ul style="list-style-type: none"> <li>■ Throttle error<br/>Throttle opening indicator lamps flash alternately*. <ul style="list-style-type: none"> <li>• Throttle dial position is misaligned with the throttle position.<br/>Contact the dealer.</li> </ul> </li> </ul>   |

---

## 7. USE OF CONTROL PANEL

---

\* Throttle opening indicator lamps flash alternately means:

[1], [3], [5], [7] ← → [2], [4], [6], [8]

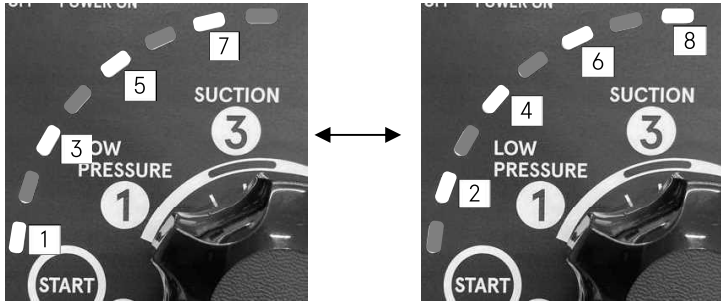

## 7. USE OF CONTROL PANEL

When the warning lamps are all off, there is no problem with each function.

\* Countermeasures (Warning lamp turns on)

It is necessary to take a countermeasure if the lamp turns on when turning on the main switch. Then take the countermeasure referring to Chapter 16 TROUBLESHOOTING.

### Warning system

<VF53BS>

| Warning indicator                    |                             |                     | High-speed<br>ESG | Low-speed<br>ESG | Engine Speed | Abnormal<br>Phenomenon   | Remedy |
|--------------------------------------|-----------------------------|---------------------|-------------------|------------------|--------------|--|--------|
| Warning lamp<br>①                    | Warning lamp<br>②           | Buzzer              |                   |                  |              |  |        |
| Fuel Shortage, Abnormal oil pressure | Overheat, Suction disabled. | Buzzer              |                   |                  |              |  |        |
| Instantaneous light                  | Instantaneous light         | Instantaneous sound |                   |                  |              | It is normal because these are system check operation when starting the system. *1                             |        |
| Turn on                              |                             | Continuous sound    |                   |                  |              | Fuel level in tank is below approximately 1/3.   | A      |
| Flashing                             |                             | Continuous sound    |                   | ON               |              | Engine oil pressure drops. *2  | B      |
|                                      |                             |                     |                   |                  |              | Failed oil pressure switch or circuit break. *6  | F      |
|                                      | Turn on                     | Continuous sound    |                   |                  | Stop         | Engine stops due to insufficient cooling water. *3   | C      |
|                                      |                             | Intermittent sound  |                   |                  |              | Preliminary warning of engine overheating. *3  |        |
|                                      | Flashing                    | Continuous sound    |                   |                  | Stop         | Engine will stop if water suction cannot be completed within 30 seconds after automatic water suction started. | D      |
|                                      |                             |                     | ON                |                  |              | Exceeded allowable engine speed. *4  | E      |
|                                      | Fast flashing               | Intermittent sound  |                   |                  |              | TPS, MAT, MAP or ETS is defective or circuit break. *5   | F      |



## 7. USE OF CONTROL PANEL

<VF63BS-R>

| Warning indicator                    |  |                     | High-speed<br>ESG | Low-speed<br>ESG | Engine Stop | Abnormal<br>Phenomenon   | Remedy |
|--------------------------------------|--|---------------------|-------------------|------------------|-------------|--|--------|
| Warning lamp<br>③, ④                 | Warning lamp<br>⑤, ⑥, (⑧)              | Buzzer              |                   |                  |             |  |        |
| Fuel Shortage, Abnormal oil pressure | Overheating, Suction disabled          | Buzzer              |                   |                  |             |  |        |
| Instantaneous light                  | Instantaneous light                    | Instantaneous sound |                   |                  |             | It is normal because these are system check operation when starting the system. *1   |        |
| Turn on ③                            |  | Continuous sound    |                   |                  |             | Fuel level in tank is below approximately 1/3.   | A      |
| Turn on ④                            |  | Continuous sound    |                   | ○                |             | Engine oil pressure drops. *2  | B      |
| Flashing ④                           |  |                     |                   |                  |             | Failed oil pressure switch or circuit break. *6  | F      |
|                                      | Turn on ⑤                              | Continuous sound    |                   |                  | ○           | Engine stops due to insufficient cooling water. *3   | C      |
|                                      | Flashing ⑤                             | Intermittent sound  |                   |                  |             | Preliminary warning of engine overheating. *3  |        |
|                                      | Turn on ⑥                              | Continuous sound    |                   |                  | ○           | Engine will stop if water suction cannot be completed within 30 seconds after automatic water suction started. Relay (mode) pump cannot start automatically. | D      |
|                                      |  |                     | ○                 |                  |             | Exceeded allowable engine speed. *4  | E      |
|                                      | Fast flashing ⑤, ⑥                     | Intermittent sound  |                   |                  |             | MAT, MAP or ETS failed or circuit break. *5  | F      |
|                                      | Fast flashing ⑤, ⑥, Flash alternately⑧ | Intermittent sound  |                   |                  |             | Faulty TPS or circuit break. *5  |        |
|                                      | Flash alternately⑧                     |                     |                   |                  |             | Throttle position and throttle dial position do not match.   | G      |

---

## 7. USE OF CONTROL PANEL

---

\*1 When the main switch is turned on.

\*2 The engine speed is controlled to be 2800 r/min or less.

- \*3 • When the engine block temperature sensor exceeds 80°C, the warning lamp flashes and buzzer sounds intermittently as a preliminary warning of engine overheating.
- When the engine block temperature sensor reaches approximately 90°C or higher, the overheat prevention device is actuated and stops the engine.
- Even if the engine block temperature sensor reaches approximately 120°C, the cell motor can be run. But the engine prevention function is actuated, and the engine cannot be restarted.

\*4 The engine speed is controlled to be 6200 r/min or less.

|    |                                       |
|----|---------------------------------------|
| *5 | TPS (Throttle position sensor)        |
|    | MAT (Manifold air temperature sensor) |
|    | MAP (Manifold air pressure sensor)    |
|    | ETS (Engine block temperature sensor) |

\*6 When the power is turned on, before the engine starts.

### Remedy

A. Refueling.

B. Check the amount of engine oil. If it is below the specified level, replenish the oil. If the specified oil level is met, consult your distributor.

|             |
|-------------|
| <b>NOTE</b> |
|-------------|

- Check the engine oil level before engine start. To confirm the engine oil level correctly, keep the engine stopped for more than 24 hours. After that, check the oil level.

C. Correct the cause of cooling water insufficiency, and then restart the engine.

D. Correct the cause of abnormality by referring to Chapter 16 TROUBLESHOOTING, and then restart the engine.

E. Turn the throttle dial to the low-pressure side. There may not be enough water left in the water suction line.

F. Except in an emergency, stop the engine and consult your local service representative.

G. Check for problems with the throttle and throttle dial linkage.

## 7. USE OF CONTROL PANEL

### Warning lamp and sensor

Turning on the main switch, warning lamps turn on and the buzzer sounds for a moment, which shows the alarm checking is done.



- After the engine has stopped due to overheating, restarting the engine immediately, the engine may be seizing. Before restarting the engine, eliminate the cause.

Refer to Chapter 16  
**TROUBLESHOOTING.**

- After that, check that the warning lamps are turned off.



### Overheat warning lamp (Warning lamp ②, ⑤)

This device monitors the engine block temperature with an engine block temperature sensor.

When the engine block temperature reaches the setting temperature of approximately 80°C, the buzzer sounds and the warning lamp ② turns on, ⑤ flashes.

When the engine block temperature reaches the setting temperature of approximately 90°C or higher, the buzzer sounds, the warning lamp ②, ⑤ turns on and the engine will automatically stop.



### Status of the warning after the overheat prevention device actuated

Once the power is turned off, the engine is started, and if the temperature exceeds 80°C, the overheat protection device including the advance warning will be actuated and a warning buzzer will sound.

---

## 7. USE OF CONTROL PANEL

---

### Precautions for restarting after the overheat prevention device actuated

1. Resolve the abnormally high engine block temperature (eliminate the cause of the abnormal temperature rise), and then restart the engine. If the cause of the abnormally high engine block temperature has not been eliminated, the engine will stop again within approximately 30 seconds. (The time it takes for the engine to stop depends on the temperature of the engine block.)
2. After solving the problem of overheating, the engine can be temporarily started even if the engine block temperature is above 90°C. This allows the engine to be effectively cooled by pumping lower temperature water.
3. The starter motor can be run even if the engine block temperature exceeds about 120°C, but the engine prevention function works, and the pump cannot be restarted.

After eliminating the cause of overheating and solving the problem, restart the engine, pump up water and discharge water, then the engine block temperature goes down, and then the warning lamp turns off and the warning buzzer stops.



- **Do not restart the engine repeatedly without solving the abnormally high engine block temperature.**

### Closed Circulating Water Cooling System

In the system, engine cooling water is taken from the suction hose water and pressurized by the pump. Some of the water passes through the engine and the muffler, and returns to the water intake of the pump.

### Warning device check

**NOTE**

- When the main switch is turned on, the warning lamps and buzzer operate for about one second. After one second, the warning lamps are turned off in the condition of power on, it shows there is no problem with each function.
- If the warning lamp turns on or flashes, the function does not work properly.

## 8. STARTING THE ENGINE

### Pump installation

#### WARNING

- Set the pump on level ground at least three meters away from inflammable materials including dead leaves and wood. Because the temperature around the engine becomes high with the muffler and exhaust gas.
- Exhaust gas, which contains carbon monoxide, is deadly poisonous gas with no color and no smell.
- Do not operate the engine in a closed space or an insufficient ventilation place such as indoor, in the vehicle, warehouse, tunnel, well, in the hold of a ship.
- Do not start the engine with the discharge valve open.
- Do not pump up and discharge liquids other than water. (e.g., flammable liquids or chemicals)
- The pump is only designed as a water pump.
- Do not discharge water to water-prohibiting substance.
- Do not run the pump without suction port strainer.
- Do not put your hand or fingers into the suction port. Putting your hand or fingers in could cause serious injury with the rotating part.

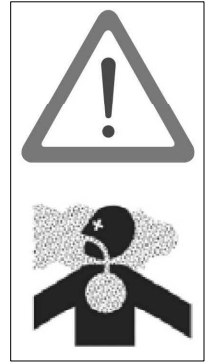

#### CAUTION

- Gravel entering the pump can damage the pump and significantly reduce its performance.

1. Place the pump near the water source on level ground.
2. Connect the suction hose and delivery hose to the pump securely. Put one end of the suction hose into the water source. The suction hose must have a strainer and a strainer basket at the tip of the hose.
3. Recommended diameter of the nozzles\* for the pump.
  - Single outlet use: in between 21.5 ~ 36(mm)
  - Twin outlet use: in between 15.2 ~ 25(mm)\*3 (m) of suction head.

## 8. STARTING THE ENGINE

### Starting engine



- **Wear a proper hearing protection during operation.**

- **While the engine is running, never touch the high voltage ignition wire connected to the spark plug. The wire has a very high voltage and can cause injury and physical harm.**

- **Do not operate the pump on dry grass. The exhaust system will be very hot and could cause the dry grass to catch fire. Clear the area if necessary.**

✓ Make sure that all the discharge valves are closed.

✓ Make sure to turn on the auto suction (priming) switch.

VF53BS: In the case of the auto priming switch is on, the engine will stop if water is not supplied within 30 seconds.

VF63BS-R: In the case of suction mode switch status is Auto (the switch lights off), the engine will stop if water is not supplied within 30 seconds.

✓ Operate it according to the operating procedure number indicated on the pump.

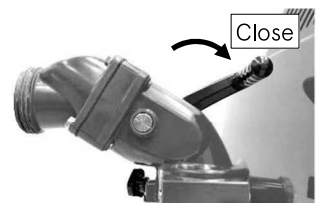
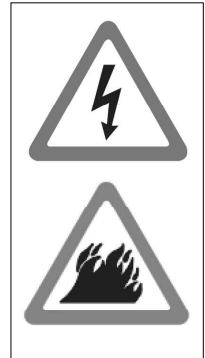

## 8. STARTING THE ENGINE

### NOTE

- Do not operate the starter motor after the engine started.
- If the starter motor does not work, check that the battery terminals are tightly connected, and the battery is fully charged.

### \_VF53BS\_

1. Turn the throttle dial to the start position.
2. Turn on the main switch and turn it to the start position to start the engine.

### NOTE

- Extended operation of the starter motor will run the battery drain. Limit the operating time of starter motor maximum 3 seconds at one time. If the engine does not start, wait for 5 seconds before operating the starter motor again.

### \_VF63BS-R\_

1. Turn the throttle dial to the low-pressure position.
2. Press the main switch until the engine starts.

### NOTE

- Pressing the start switch, when the engine does not start, if the start switch is held down, the starter runs for 3 seconds, then the engine stops with a buzzer sounding for 5 seconds, and the starter runs again. Repeat this.

### Starting engine using a manual starter

If the electric starter does not work, use a manual starter to start.



### WARNING

- **Do not try to start manually when motor is running.**



### CAUTION

- **Install the battery to start the engine and operate the pump, even if the battery is insufficient charged. If the battery is not installed and not connected, the electrical equipment may malfunction.**

### \_VF53BS\_

1. Turn the throttle dial to the start (low-pressure) position, and turn the main switch to the ON position. Start the engine by pulling the starter handle.

### NOTE

- Engage the manual starter ratchet by pulling the starter rope slowly. And then pull the starter handle quickly with great force from the position in which feeling harder resistance.

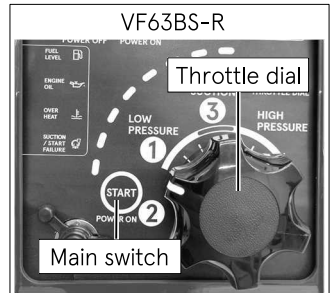
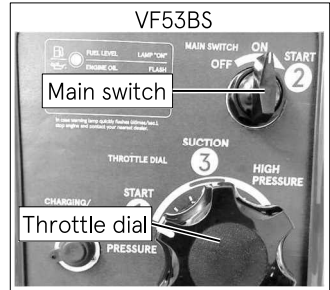

## 8. STARTING THE ENGINE

- Once the engine starts, turn the throttle dial to the suction position.

\*Operate the pump as the same way with battery started case.

In the case of the auto priming switch turns on, the vacuum pump will run automatically.

In the case of the auto priming switch turns off, pull the manual suction knob and operate the vacuum pump to suck up water. Confirming the completion of suction water, then return the knob and the throttle dial to the low-pressure position.

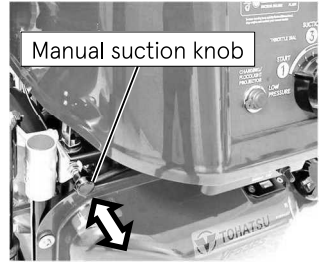

### VF63BS-R

- Turn the throttle dial to the start (low-pressure) position. To start the engine, pull the starter handle forward until the handle feels heavy and pull it quickly with great force.
- Once the engine starts, press the start switch and operate the pump as the same way with the starter motor/battery started case.

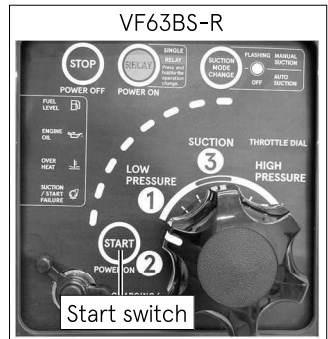

#### NOTE

- The operation time of the vacuum pump should be within 30 seconds.
- If the water suction cannot be completed within 30 seconds, there is another problem.

### Dry operation

Since the cooling system of the portable pump uses water from outside as cooling water, limit the duration of dry operation\* so that it is within the following time periods.

\*Dry operation: Running engine without water.

Doing dry operation longer than the specified time period may cause damage to the engine or pump.

- Throttle dial at low pressure (idle) position: Within 2 minutes
- Throttle dial at suction position: Within 30 seconds

### Closed discharge valves operation after priming water

When the pump is operated with the discharge valve closed, the cooling water temperature becomes high.

#### CAUTION

- Continued operation of the discharge valve closed after water suction will cause the pump to overheat.





## 9. PRIME AND DISCHARGE

### WARNING

- While the engine is running with the cowl removed, do not touch the rotating parts such as the pulleys and belts. It may cause personal injury.



### NOTE

If, when operating the vacuum pump for 30 seconds, the pump does not suck up water or if the water can not be pumped up continuously by the pump during the water discharge operation, check the following:

- Is the tip of the suction hose completely below the water surface?
- Is the suction hose damaged?
- Is the vacuum performance of the priming (vacuum) pump significantly reduced?
- Does the pump have a vacuum leak?
- Does the vacuum leak occur when the pump is connected with the suction hose which is capped at the tip of the hose?

Refer to Chapter 16 TROUBLESHOOTING.

1. Once the engine starts, turn the throttle dial to the suction position.
2. The vacuum pump operates automatically until the suction completed (Maximum operating time is for 30 seconds). When the water suction completed, the vacuum pump automatically stops.
3. When the vacuum pump stops, return the throttle dial to the low-pressure side.

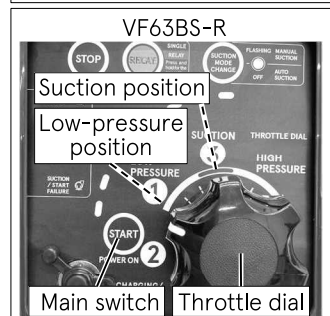
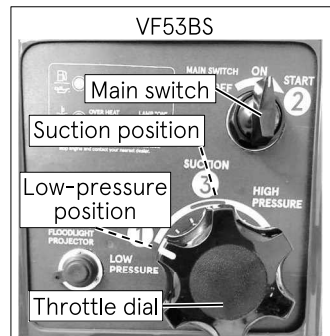

---

## 9. PRIME AND DISCHARGE

---

**NOTE**

In the auto suction mode,

- If water cannot be supplied within 30 seconds, the engine will stop automatically.
- If the engine speed is low and the vacuum pump is not operated, the engine will stop automatically in about 30 seconds.

4. Make sure that the water pumped up is drained from the priming outlet of the vacuum pump, and make sure the pressure gauge is showing positive side.

**NOTE**

- The vacuum pump automatically operates for (maximum) 30 seconds.
- If the water suction cannot be completed within the time that the vacuum pump operates, there are some other problems. Check up the cause.

Refer to Chapter 16 TROUBLESHOOTING.

Start to discharge water after informing the people who are on the hose side.

5. Open the discharge valve handle slowly to start discharging water.

**CAUTION**

- **Before opening the water discharge port or valve of the pump, confirm the operators holding the nozzle or the branch pipe, that have already checked the nozzle opened and ready to discharge water.**
- **During operation, check the suction and discharge hoses. It must be free of kinks, pinches, etc., possibly caused from emergency vehicles rolling over hose.**

**NOTE**

- To avoid the air left in the hose, the pump should be located above the suction hose. If some air left in the hose, the pump may not be able to discharge water by the accumulated air in the hose when the discharge valve is opened. In this case, open the discharge valve and operate the vacuum pump for 3 to 5 seconds until the water is continuously discharged.

---

## 9. PRIME AND DISCHARGE

---

6. Checking the pressure and gradually turn the throttle dial to adjust the pressure.

 **CAUTION**

- In the case of using a branch pipe, the person holding the branch pipe must be informed of changes in water discharge pressure caused from engine speed changes and/or discharge water valve opening setting changes.
- Do not direct the nozzle toward people under any circumstances.
- Do not look into the nozzle opening at any time.
- Do not put fingers or a hand into the discharge nozzle.



## 9. PRIME AND DISCHARGE

### Relay pumping water operation



- In the case of relay pumping operation training on level ground, If the extension hose (inner diameter  $\phi 65$ ) is less than 200 m, use the pumping plate (safety nozzle) attached.

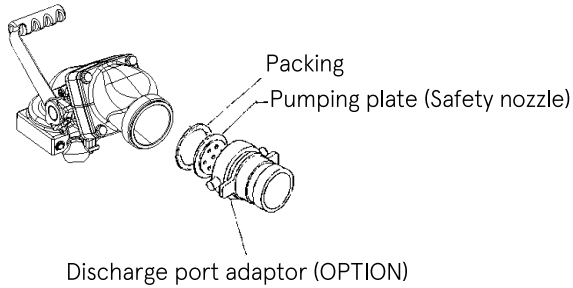

### Description of relay pumping operation

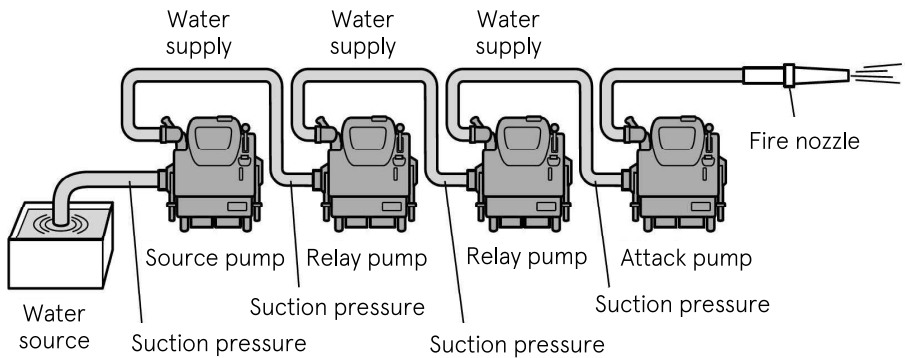
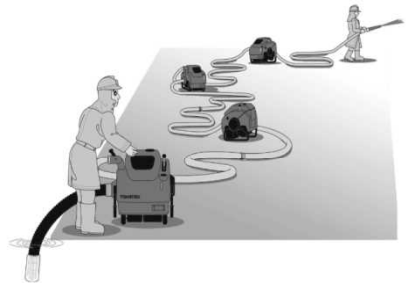

---

## 9. PRIME AND DISCHARGE

---

### Preparation for operation

**WARNING**

- **Do not close the discharge valve of source pump, relay pumps and fire nozzle(s). If the discharge valves or nozzle is (are) closed during relay water supply, there will be a risk of damage to the pumps and hoses with excessive pressure or water hammer.**

1. Decide how many relay pumps are needed in consideration of distance and height between the water source and the fire ground.
2. Place the pumps according to the decision and connect the hoses.
3. Make sure that the discharge valves are all opened, including the fire nozzles.
4. Decide the discharge pressure of each pump in consideration of the needed pressure for the next pump (or fire nozzle), height loss and hose pressure loss (friction loss).

Pump pressure = needed pressure + height loss + friction loss

### Start the source pump

**WARNING**

- **Once the water supply has started, keep supplying it until finished. If reducing or stopping to supply water, overheating or cavitation may occur in the relay pumps.**

< Auto suction (priming)>

1. Make sure that the discharge valves and the fire nozzle(s) are all opened.
2. Turn on the auto suction.
  - VF53BS: Turn on the auto suction switch. \*
  - VF63BS-R: Choose the operating mode of single (stand-alone).

Press the suction mode switch to change the mode if necessary. Choose the auto suction mode. \*

3. Start the source pump. Refer to Chapter 8. STARTING THE ENGINE.
4. Start the engine and turn the throttle dial to the suction position.

\* The pump will start to suck up water (priming) if the suction mode switch is chosen auto mode. If the suction mode switch is chosen manual mode, suck up water manually.

---

## 9. PRIME AND DISCHARGE

---

### Starting relay pump

1. Make sure that the discharge valve is opened, and wait for water supply.  
VF53BS: Turn off the auto suction switch.  
VF63BS-R: Choose the relay pump mode\*. Press the operation mode switch if necessary.  
\* Press the operation mode switch once for about 2 seconds, the mode switches between the relay water supply mode and single (stand-alone) mode. And then make sure that the switch turns on red and buzzer sounds (intermittent sound).  
At first, the hose swells due to air pressure. Check that the water was supplied from the source pump, step on the hose to judge whether the swelling of the hose is due to water or air if possible.
2. When the water pressure of the relay pump raised to more than 0.1MPa (15psi) due to the water sent from the source (previous) pump (If it becomes clear that water was supplied to the pump),

#### **\_VF53BS\_**

- Check the pressure with the pressure gauge. Start the engine when discharge pressure is lower than the decided pressure. If the pressure is higher than decided pressure, no need to start the engine.
- Adjust the discharge pressure with throttle dial. Always check the discharge pressure and suction pressure with the pressure gauges. If the suction pressure goes down below 0.1MPa (15psi), order the operator of the previous pump to increase the discharge water pressure, and adjust the relay pump pressure with the throttle dial. If the suction pressure rises, adjust the pressure again with the throttle dial.

#### **\_VF63BS-R\_**

- The relay pump starts automatically. (Refer to Start cycle control\*1.) The pump controls the suction water pressure which is about 0.15MPa (22psi). Pressure adjustment by the relay pump is not required while the relay pump mode is chosen.

**The throttle dial does not work while the relay pump mode is chosen.**

- To change the operation mode of the pump from relay to single or single to relay pumping operation during relay pumping operation, the throttle dial position should be at the low-pressure position. Check the throttle dial position. Press the operation mode switch for about 2 seconds to change the mode, and check the mode (Switch light color: Blue: Single /Red: Relay).

---

## 9. PRIME AND DISCHARGE

---

- If the suction side water pressure goes down below 0.05 MPa (7psi) for about 15 seconds, the pump will stop automatically. The pump is on standby.
- To stop at emergency, press the stop switch.

### \*1. Start cycle control

- Standby mode: Switching the operation mode to relay water supply mode, setting the throttle dial position to start (low-pressure), and waiting for water supply from the source pump. (The operation mode switch (relay/red) flashes.)
- Control the starting: When the water pressure of the pump rises above 0.13MPa (19psi) by the water from the source pump, the engine starts automatically.

#### ➤ Starter motor operates automatically.

If the engine doesn't start, starter motor runs again. (Max 6 times (runs for 3 seconds, stops for 5 seconds)) This is for stable starting operation by the starter motor and save battery energy. If the engine doesn't start in 6 times starting operations, then warning lamp⑥will turn on. (Suction/Start failure).



- Air-Water decision: Even if a large amount of air comes from the source pump to the relay pump, the pump internal pressure could rise, and the relay pump will start. The VF63BS-R relay pump checks whether this pressure rise is due to air or water. If it is judged that the raised pressure is caused by the air, the pump will stop automatically, the operation mode switch will flash and a buzzer will sound. This is to prevent overheating of the engine. Approximately 30 seconds after the engine stopped, the pump will be at the standby mode.
- Discharge water pressure limiter: Throttle position is controlled to make the discharge pressure will not be over about 1 MPa.
- Suction water pressure limiter: Throttle position is controlled to make the suction water pressure will not be below about 0.15MPa (22psi) to prevent the hose from being crushed.
- Auto stop: Even if the throttle position is controlled at start (low-pressure) position, still the suction water pressure is below 0.05MPa (7psi), then the engine will stop automatically because of suction water shortage. The pump will be standby mode state.

---

## 9. PRIME AND DISCHARGE

---

### Starting of attack pump operation

It is the same as for the relay pump operation.

### Finishing of relay pump operation

1. Keep all the discharge valves and the nozzle(s) opened.  
Do not close the valves or the nozzle(s) first.
2. Stop the operation one by one from the pump closest to the nozzle.
  - \* Stop the relay pump which is closest to the nozzle first. After that, stop the second closest relay pump to the nozzle. Then stop the third relay pump, in order. Finally, stop the source pump.
  - \* The signal to stop should be given by the nozzle operator first.
3. Drain all the water from the pumps.



- **Do not touch the exhaust pipe and the muffler while the engine is running, and do not touch it for 10 minutes more after the engine has been stopped. These parts are very hot and will cause severe burns.**





---

## 9. PRIME AND DISCHARGE

---

### < When using fire hydrant water for relay water supply >

1. Decide the pump pressure in consideration of the water discharge pressure (nozzle pressure), height pressure loss and hose pressure loss (friction loss).

$$\text{Pump pressure} = \text{needed pressure} + \text{height loss} + \text{friction loss}$$

2. A fire hydrant may contain foreign materials such as dirt, gravel, or iron rust. Before connecting a hose, open a fire hydrant to discharge water to remove foreign materials.
3. When using water from a fire hydrant, set a relief valve between the delivery hose and the suction port. And use a delivery hose (for high pressure) to connect the suction port instead of a suction hose in principle. Because the water pressure of the fire hydrant could be very high.
4. Open the discharge valve all the way.
5. Gradually open the fire hydrant on-off valve. However, check the water pressure from fire hydrant with suction pressure gauge of the pump, and adjust the valve opening of fire hydrant, if necessary.

 **CAUTION**

- **If the water pressure from the fire hydrant is higher than 0.6MPa (87psi), do not open the fire hydrant on-off valve more.**
  - **If the water pressure from the fire hydrant is higher than the required discharge pressure, it is not necessary to run the pump.**
  - **Too high pressure could damage the hose, pump, and water line.**
  - **If the water pressure from fire hydrant has not reached the required pressure, start the engine.**
6. If the water pressure from fire hydrant is insufficient, start the engine and adjust the pressure to the required level by operating the throttle dial.  
Stop increasing discharge pressure if the suction pressure gauge shows 0.1MPa (15 psi) or below. Keep (Operate) the throttle dial not to make the suction water pressure below 0.1MPa (15psi).
  7. At the end of discharging water, turn the throttle dial to the start (low-pressure) position first, then stop the engine, and close the fire hydrant on-off valve.

 **CAUTION**

- **Make sure not to close the discharge valves and nozzle(s) before all pumps stop and the fire hydrant on-off valve is closed. If the discharge valves or nozzle(s) are(is) closed, there will be a risk of damage to the pumps and hoses with excessive pressure or water hammer.**
8. Open all the drain valves to drain the remaining water as maintenance after the operation.

# 9. PRIME AND DISCHARGE

Control panel operation table

VF63BS-R

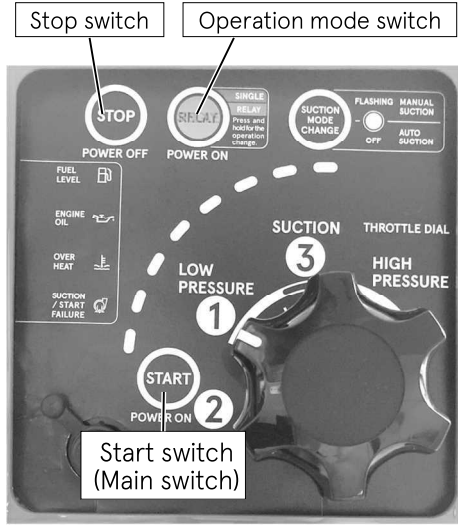

| Lighting status | Action  | Power OFF<br>↓<br>SINGLE (Stand-alone)            | Power OFF<br>↓<br>RELAY                            | SINGLE (Stand-alone)<br>↓<br>RELAY                 | RELAY<br>↓<br>SINGLE (Stand-alone)                 | SINGLE (Stand-alone)<br>↓<br>Power OFF | RELAY<br>↓<br>Power OFF |
|-----------------|---|---|--|--|--|--|-------------------------|
|                 | Operation Switch  |   |  |  |  |  |                         |
| State           | Start switch (Main switch)  |   |  |  |  |  |                         |
|                 | • Power off<br>• Engine stop<br>Operation mode switch : Light off                 | Operation mode switch or Start switch (one press) | Operation mode switch (Press for around 2 seconds) |  |  |  |                         |
|                 | • SINGLE mode (Stand-alone)-<br>Operation mode switch : Blue light (SINGLE)       |   |  | Operation mode switch (Press for around 2 seconds) |  | Stop switch (One press)                |                         |
|                 | • RELAY mode-<br>Operation mode switch : Red light (RELAY) and Intermittent sound |   |  |  | Operation mode switch (Press for around 2 seconds) |  | Stop switch (One press) |

# 10. STOPPING THE ENGINE

## Stopping the engine

1. Return the throttle dial to the start (low-pressure) position.



2. Close the discharge valve handle(s).

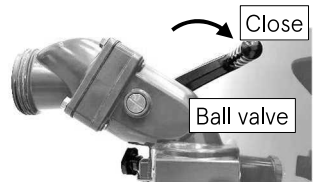

3. Turn off the main switch.

VF53BS: Turn off the main switch.

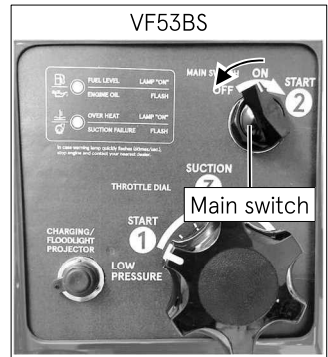

VF63BS-R: Press the stop switch until the engine stops.



# 11. MAINTENANCE AFTER OPERATION

## Drain water

1. Open the drain valves to drain all the water from the pump. Do not leave water in the pump.
2. Close the drain valves for the next operation.

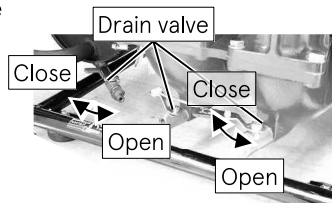

## Dry operation for vacuum pump

### (Check suction performance)

After the drainage of all the water from the pump,

1. Open the drain valves of muffler and pump. Start the engine and run the vacuum pump for 10 seconds to drain out all the water.
2. Close all the drain valves and the suction port (with a cap, etc.). Close all the drain valves.

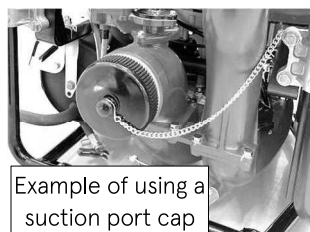

### NOTE

- Close the suction port not to leak air into the pump.

## \_VF53BS\_

- 3-1. Confirm the throttle dial is at the start position and turn on the Auto-suction switch.
- 4-1. Start the engine turning the main switch.
- 5-1. Turn the throttle dial to the suction position, then the suction operation will start automatically
- 6-1. The engine runs for about 30 seconds and then the engine will stop automatically because of suction water failure.

\* This is for vaporizing the water in the vacuum pump and in the water pump, and then drain out the vapor.

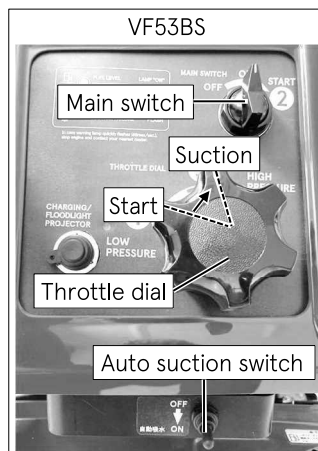

# 11. MAINTENANCE AFTER OPERATION

## \_VF63BS-R\_

3-2. Confirm the throttle dial is at the start (low-pressure) position and press the start switch to start the engine.

4-2. Switch the suction mode to auto suction.

5-2. Turn the throttle dial to the suction position, then the suction will start.

6-2. Run the engine for about 30 seconds.

The engine will stop automatically because of suction water failure.

\* This is for vaporizing the water in the vacuum pump and in the water pump, and then drain out the vapor.

7. Check the vacuum pressure of suction is at around -0.08MPa (-12psi).

8. In order to check if there is no vacuum leak, leave it for 30 seconds and check that the pointer of the pressure gauge for suction keeps the same indicated pressure.

9. Open the drain valves slowly to expose it to the atmosphere, and check that the pointer of the pressure gauge for suction returns to "0".

10. Close the drain valves again.

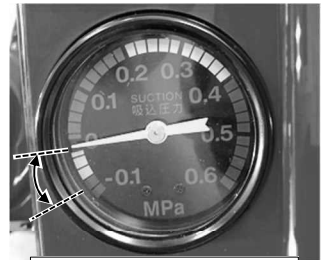
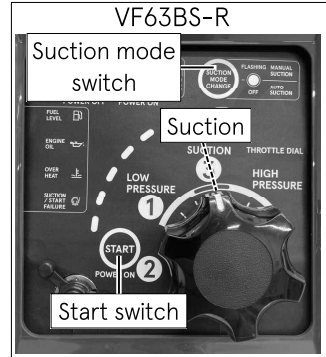

Vacuum pressure gauge

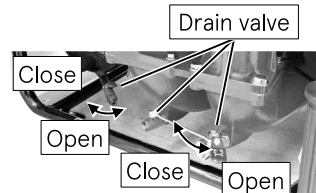

### NOTE

- Before storing the fire pump, flush with fresh water to purge debris from the pump. (Especially after using salt water, muddy water, contaminated water, etc.)
- Worn rubber seals (Rubber gaskets, O-rings, seals for the discharge and suction hose fitting wear) will cause water leaks, poor vacuum. Frequent inspection of these items is mandatory.

# 11. MAINTENANCE AFTER OPERATION

## Fuel and Oil

### 1. Fuel

Fill the fuel tank to the maximum level.

The maximum level can be confirmed by the fuel level gauge indicator (red).



- **Wipe off fuel using a cloth or the other materials if there is fuel out of the fuel tank.**

### 2. Engine oil

Fill the engine with 4-stroke engine oil.

Classification:

API: SH, SJ, SL

SAE: 10W-30/40

#### NOTE

- A new pump is shipped with no oil in the engine.
- Before using the pump, fill it with the designated amount of engine oil.
- Be sure to use oil having viscosity suitable for the external air temperature of the area where the pump is used.

Check the amount and cleanliness of the engine oil through the window installed on the oil pan. To confirm the engine oil level correctly, keep the engine stopped for more than 24 hours, then check the oil level.

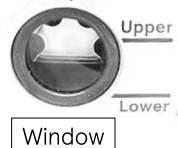
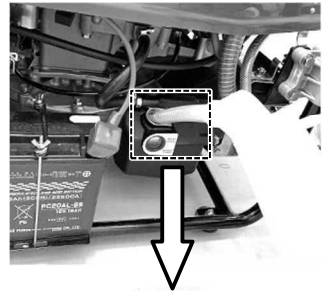
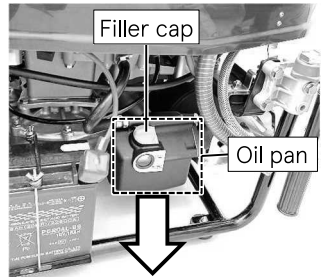

---

## 11. MAINTENANCE AFTER OPERATION

---

### Cleaning the strainer for priming water

Remove the strainer and clean it with fresh water. If the strainer is dirty with dust, etc., vacuum performance efficiency will be reduced.

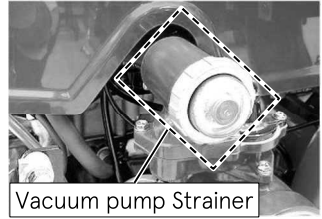

#### CAUTION

- When installing the strainer, exercise care so that the O-ring does not get caught in, and tighten the ring nut securely. If the ring nut is not tightened completely, a vacuum leak may occur

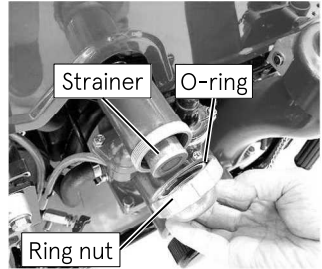

#### NOTE

- When assembling the strainer, tighten the ring nut while holding and pushing the strainer cup.

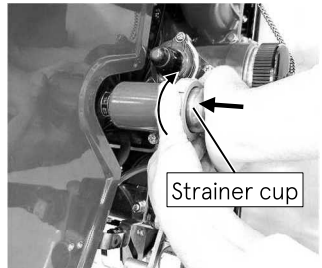

### Maintenance after pumping seawater or foul water

In case of pumping seawater or foul water, the pump should be flushed out with fresh water immediately to prevent excessive corrosion. And operate the vacuum pump to flush out with fresh water for 5 seconds at low engine speed in order to clean the vacuum pump.

---

## 11. MAINTENANCE AFTER OPERATION

---

### Charging battery

#### <Battery>

 **WARNING**

- Read the safety instructions and/or warnings carefully before using or charging the battery.
- Hydrogen gas from the battery is explosive.
- Keep the battery away from flames and sparks.
- Charge the battery in well ventilated area. Do not charge battery in unventilated area.

 **CAUTION**

- Connecting battery cables, connect positive (+) lead first.
- Disconnecting battery cables, disconnect negative (-) lead first.

**NOTE**

- Keep surface of the battery clean.

#### <Battery charger>

 **WARNING**

- The battery capacity must be 12V-18Ah/10HR.
- Do not connect anything other than the specified battery charger to the battery charging connector.
- Hydrogen gas inside the battery may explode if something sparks.
- Keep the battery away from flames and sparks.
- Charge battery in well ventilated area.

 **CAUTION**

- Use an automatic battery charger.
- Use a battery charger that has an overcharge prevention function.
- Read the instruction manual of the battery charger before charging a battery.
- Automatic charger should be kept in a dry and well-ventilated place.



# 11. MAINTENANCE AFTER OPERATION

1. Be sure to charge the battery after each operation.

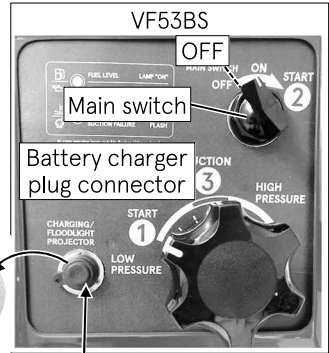

2. Turn off the power of the pump.

3. Confirm that there is no dirt, no slack, no backlash of the terminal.

4. Plug the charging plug into the pump battery charger plug connector first.

5. Plug the power plug of the charger into AC power source next.

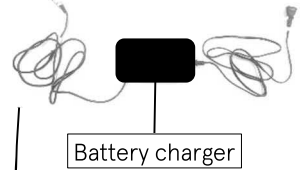

6. Confirm the battery charging status.

\* Refer to the instruction manual of the battery charger.

7. Disconnect the battery charger plug from the connector when using or moving the pump.

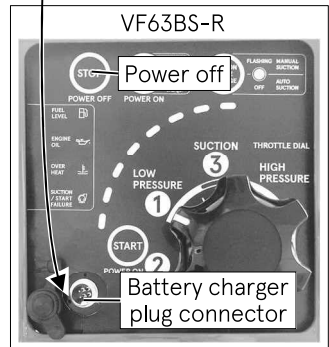

## NOTE

- If the main switch is on, the battery cannot be charged.
- Pull out the battery charger plug from the connector when using or moving the pump.

---

## 12. MAINTENANCE IN COLD CONDITION

---

### Infuse anti-freezing fluid



#### CAUTION

- If the temperature around the pump could be subzero, the inside of the pump can be frozen. In this case, the water pump or vacuum pump may not work. Also, the pump unit including engine and muffler may be damaged or broken.
- In order to prevent internal corrosion and freeze damage by the water in the pump, drain all water from the pump after each use.
- After draining the water, put antifreeze fluid into the pump and vacuum pump.

### Pump unit

1. When storing the pump, drain all the water from the pump. Open the pump drain valves and muffler drain valve to drain all water from the pump.
2. Close the pump drain valves and muffler drain valve. Close the suction port (with a cap, etc.).
3. Start the engine and turn on the auto suction switch. Turn the throttle to the suction position to run the vacuum pump for about 5 seconds to take the water off on the rotating part.
4. Stop the engine. Open all drain valves (and the suction cap) to drain the remaining water.
5. After draining completely, close the pump drain valves and close the suction port (with a cap, etc.). (Open the muffler drain valve.)
6. Connect the plastic (vinyl) pipe (accessory) to the muffler drain valve.
7. Put the plastic pipe coming out of the vacuum pump and plastic pipe connected to the muffler drain valve into the container containing the antifreeze (Undiluted solution 500 mL (0.13 USG)).

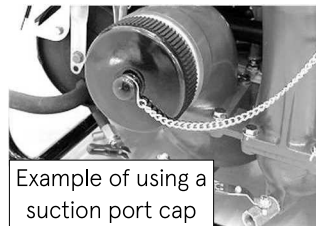
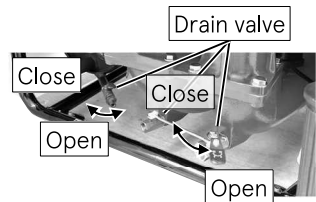

## 12. MAINTENANCE IN COLD CONDITION

8. Start the engine.

### VF53BS\_

- Turn on the auto suction switch,
- Set the throttle dial to the low-pressure position. Turn the main switch to start the engine.
- Turn the throttle dial to the suction position and run the engine until the engine automatically stops (about 30 seconds) because of suction failure.

### VF63BS-R\_

- Set the throttle dial to the low-pressure position. Press the main switch to start the engine.
- Make sure the suction mode is auto-suction. Switch the suction mode to auto-suction pressing the suction mode switch if needed.
- Turn the throttle to the suction position and run the engine until the engine automatically stops (about 30 seconds) because of suction failure.

### NOTE

- Do not stop the engine even if the antifreeze runs out. Be sure to run the engine until it stops automatically.

9. Stop the engine.

### VF53BS\_

- Turn the throttle dial to the low-pressure position and turn off the main switch (turn off the power).
- Close the muffler drain valve.

### VF63BS-R\_

- Turn the throttle dial to the low-pressure position and press the stop switch to stop the engine (turn off the power).
- Close the muffler drain valve.

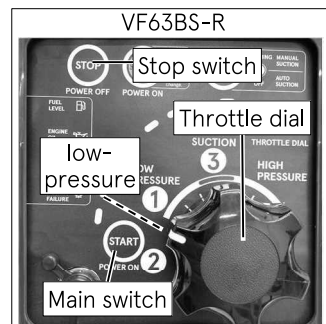
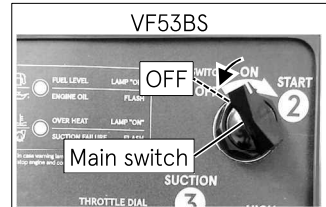
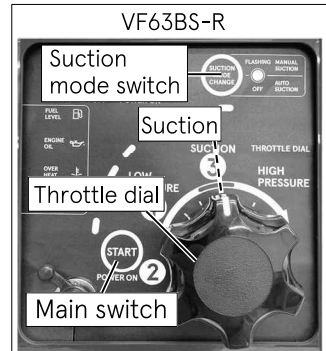
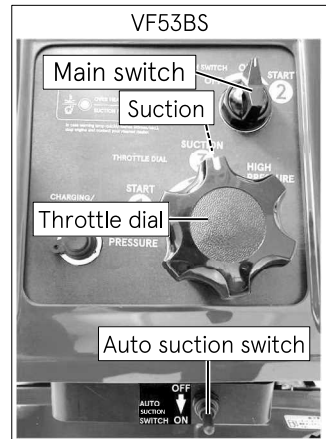

---

## 12. MAINTENANCE IN COLD CONDITION

---

10. Pour antifreeze into the seal area of the discharge valve.

**NOTE**

- To use a long nozzle container is helpful when pouring antifreeze fluid.

11. Open the pump drain valves to collect the antifreeze.

12. Close the valves and remove the plastic pipes.

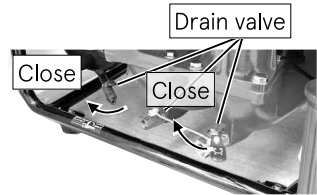
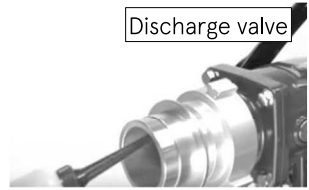

## 13. USE OF ACCESSORY

### Battery

Battery performance deteriorates in a low-temperature condition. Further, a battery could freeze easier if the specific gravity is low.

#### WARNING

- Hydrogen gas from a battery is explosive. Keep a battery away from flame and sparks.
- Hydrogen gas emitted from a battery will also cause severe burns to skin and damage.
- Charge a battery in well ventilated area. Do not charge a battery in an unventilated area.

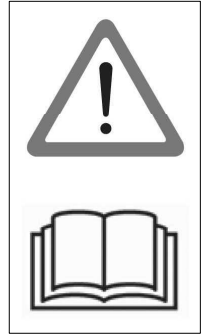

#### CAUTION

- Read the instructions attached to the battery carefully before use.
- When charging the battery, be sure to use an automatic battery charger.
- Use the automatic battery charger that matches the battery specifications. Use of a mismatched automatic battery charger may cause the battery to explode.
- Keep the battery surface clean.
- Battery life is normally 2~3 years even if the battery is used properly. Replace with new battery every 2~3 years checking the deterioration of the charging performance.
- When connecting battery cables, positive (+) lead shall be connected first. (When disconnecting battery, remove the negative (-) lead first.)
- Battery electrolyte is very corrosive acid that can cause severe skin burns and damage to clothing.

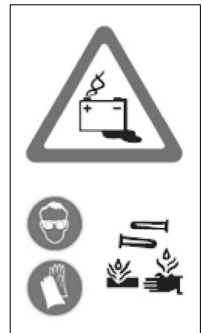
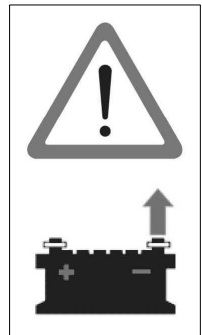

### Battery charger

#### CAUTION

- Read the instruction manual of the battery charger. The instruction manual is packed with the charger.
- Set the battery charger on a suitable nonflammable stand, not directly onto the ground.

---

## 13. USE OF ACCESSORY

---

### Pumping plate



#### CAUTION

- In the case of using a fire pump without a nozzle as a water supply pump, such as pumping water from a basement, put the pumping plate (which has holes) in between the discharge port adaptor and the packing in order to prevent the overheating of the engine and the pump cavitation which may cause damages to the pump.

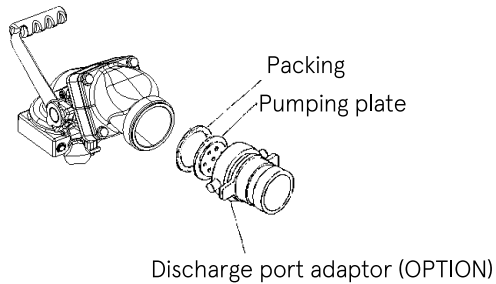

#### NOTE

- Put the pumping plate as the figure shown above, so that pressure for cooling water in the pump is maintained at certain level. Then the pump can be used without the discharge nozzle.

## 14. PERIODICAL INSPECTION

Be sure to inspect the fire pump according to the following inspection list.

| Inspection Item                        | Operating Time or Period                      | Description of Inspection                 | Action   | Remarks |
|--|---|---|--|---------|
| Fuel                                   | After each use                                | Fuel inside of tank                       | Replenish  |         |
| Engine oil                             | Before each use<br>Before starting the engine | Check if there is the specified amount.   | Replenish  |         |
|  | 100 hours or 1 year                           | -   | Replace*   |         |
| Oil filter                             | 200 hours or 3 years                          | -   | Replace  | ○       |
| Valve clearance                        | 100 hours or 1 year                           | Inspect                                   | Adjust   | ○       |
| Timing belt                            | 100 hours or 1 year                           | Crack, wear                               | Replace  | ○       |
| Air filter (for ISC)                   | 200 hours or 3 years                          | -   | Replace *  |         |
| Fuel filter                            | 50 hours or 6 months                          | Inspect                                   | Clean the filter.                                    |         |
| Fuel hose                              | 50 hours or 6 months                          | Damage, leak from joint area              | Replace *  |         |
| Spark plug                             | 100 hours or 1 year                           | Fouling, wear, gap (0.8 – 0.9 mm)         | Clean, correct or replace.                           |         |
| Battery                                | Every month                                   | Voltage                                   | Replace if necessary.                                | ○       |
| Starter rope                           | Every month                                   | Wear, damage                              | Replace  |         |
| Vacuum pump strainer                   | After each use                                | Clogging or broken mesh                   | Clean the strainer.                                  |         |
| Vacuum pump driving belt (V-belt)      | 100 hours or 1 year                           | Crack, wear                               | Replace *  | ○       |
| Cooling water passage                  | 100 hours or 1 year                           | Water temperature, clogging water         | Replace parts if necessary.                          | ○       |
| Pump and related components            | 50 to 100 hours or 1 year                     | Performance check                         | Replace parts if necessary.                          | ○       |
| Discharge valve and related components | After every 50 to 100 hours or 1 year         | Vacuum leak, handle open/close smoothness | Replace parts if necessary.<br>Apply designated oil. | ○       |
| Compression pressure                   | 200 hours or 1 year                           | Compression pressure                      | Replace parts if necessary.                          | ○       |
| All components                         | 300 hours or 3 years                          | Overhaul                                  | Replace parts if necessary.                          | ○       |

Note: 1) Regarding the inspections and actions for the items indicated by the “○” symbol in the remarks column, as well as the changes of parts indicated by the symbol “\*” in the action column, please make a request to the local service representative.

2) Inspection interval which has been reached earlier in the operating time and the periodic inspection period should be the inspection timing.

## 14. PERIODICAL INSPECTION

The following table shows the parts that are recommended to be changed periodically.

| Parts Name                                  | Recommended Replacement Frequency | Problem Occurred   |
|---|-----------------------------------|--|
| Spark plug                                  | 1 year                            | Unable to start due to wear of electrode                     |
| Fuel hose                                   | 2 years                           | Fuel leak due to deterioration                               |
| Battery                                     | 2 years                           | Life expiration  |
| Oil hose                                    | 3 years                           | Oil leak due to deterioration                                |
| Oil filter                                  | 3 years                           | Overheating of engine  |
| Air filter (for ISC)                        | 3 years                           | Engine revolution failure                                    |
| Vacuum pump driving belt                    | 3 years                           | Slip due to wear   |
| Timing belt                                 | 3 years                           | Valve timing deviation                                       |
| Other rubbers                               | 2 years                           | Functional deterioration                                     |
| Starter rope                                | 3 years                           | Breakage due to wear   |
| Fuel filter                                 | 3 years                           | Unable to start due to clogging with dust or mixing of water |
| Discharge reverse flow check valve (rubber) | 3 years                           | Functional deterioration due to wear                         |
| Mechanical seal                             | 3 years                           | Unable to suck water due to wear                             |
| Vane for oil less vacuum pump               | 3 years                           | Unable to suck water due to wear                             |
| Fuel tank                                   | 10 years                          | Functional deterioration due to corrosion                    |

Parts to be simultaneously changed during disassembly:

- Gasket
- O-ring

and the other parts which have damages should be changed.



## 15. SERVICE AND MAINTENANCE

### General

Servicing and maintenance of the fire pump must only be carried out by personnel who have professional related knowledge and who are familiar with the fire pump and regulations regarding safety and accident prevention.

Before starting maintenance work:

- Stop the engine.
- Place the pump on level ground.
- Disconnect the negative terminal of the battery.

### Safety devices



- **If the safety or protective devices have been disassembled in the servicing and maintenance work process, immediately install them back to the original position after the maintenance. Make sure that they work normally without problems.**



### Genuine parts

When replacing parts as a part of servicing and maintenance of the fire pump, use only Tohatsu genuine parts. If genuine Tohatsu parts and accessories are not used, it may adversely affect the function and safety of the fire pump.

Therefore, for safety reason, use only Tohatsu genuine parts.

Tohatsu bears no responsibility for any personal injuries or equipment damages that may result from use of parts or accessories obtained from outside sources.

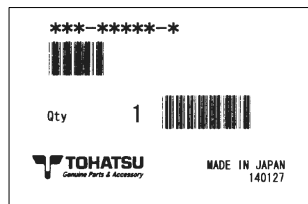

### Environmental protection measures

Dispose of oil, fuel, batteries, etc. according to relevant environmental laws in the region.

Do not dump to nature or sewerage.



### Waste

When discarding parts, go waste in accordance with environmental laws in the region procedure.

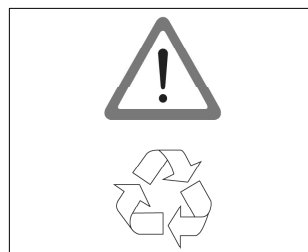

## 15. SERVICE AND MAINTENANCE

### Cowl removal and installation

#### Cowl removal

Pull up the two cowl hooks on the back first, then pull up the two cowl hooks on the front and slowly lift the entire cowl.



- Carefully remove the cowl so that it does not come in contact with the discharge valve and as little as possible with the starter handle.

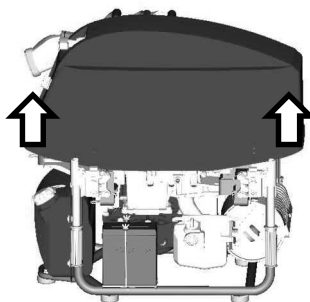
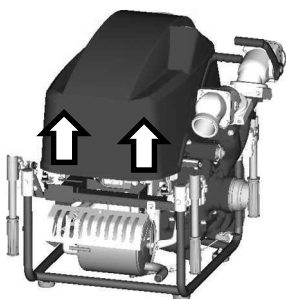
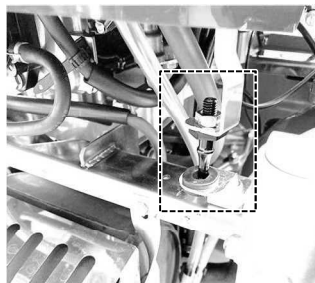

#### Cowl installation

Assemble in reverse order of removal.

Pass the manual starter handle through the front of the cowl, place the cowl on the pump, and secure the cowl with the four hooks.

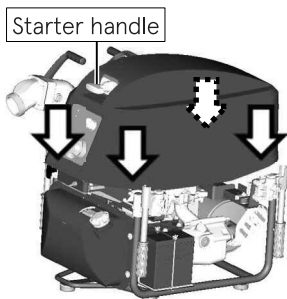

#### Vacuum pump driving belt (V-belt)

Check the V-belt every year or every 100 hours operating time.

V-belt size: LA-26

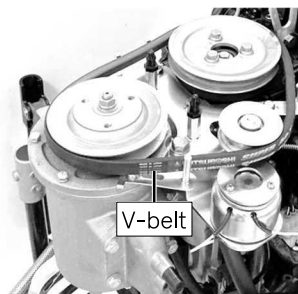

---

## 15. SERVICE AND MAINTENANCE

---

### Vacuum pump strainer

#### Maintenance

**NOTE**

- Incorrect installation of the strainer may cause a vacuum leak. Be sure to install the strainer correctly.

Refer to Chapter 11 MAINTENANCE AFTER OPERATION.

Wash the strainer with fresh water after use.

1. Turn the ring nut while pushing and holding the strainer cup. Remove the vacuum pump strainer.

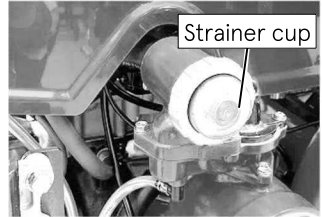

2. Wash the strainer and the strainer cup.

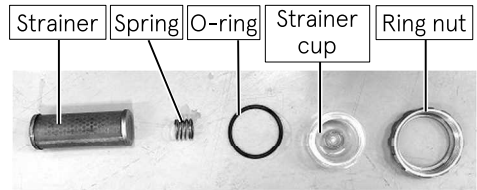
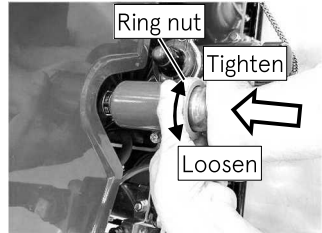

3. After the washing, reassemble the strainer.

**NOTE**

- When installing the strainer, pay attention to the protrusion of the O-ring and install it correctly. Otherwise, a vacuum leak may occur.
- Refer to the picture for assembly parts and assembly order.



## 15. SERVICE AND MAINTENANCE

### Engine oil

#### Check the oil level

Check the oil level **before starting the engine.**

The correct engine oil level cannot be confirmed running the engine and just after running. Wait 24 hours to check the level correctly.

\* The engine oil stays in some parts inside the engine.



- **Make sure the filler cap is tightly closed except refilling the engine oil each time.**
- **Check the oil level before each operation.**

1. Place the pump on level ground (horizontal).
2. Check the oil level.
3. Add the oil until upper level if the oil level is low.

#### NOTE

- 4-stroke engine oil:  
API: SH, SJ, SL  
SAE: 10W-30/40

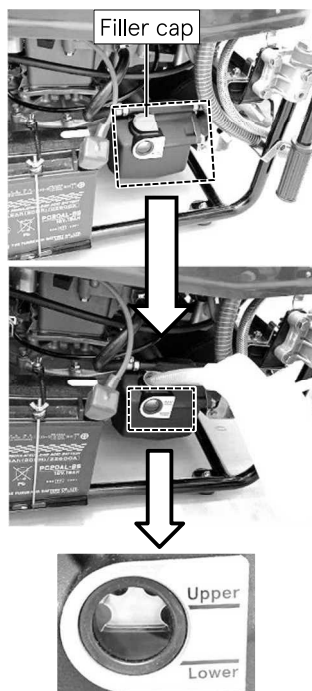

#### Engine Oil Change

It is recommended that oil changes be done by the dealer.

1. Stop the engine and remove the oil filler cap after the engine has cooled sufficiently.
2. Raise the two carrying handles on the water suction side and tilt the pump.
3. Place the oil drain pan under the oil drain plug.
4. Remove the oil drain plug and drain the oil.
5. Tighten the oil drain plug.

\*Apply oil to the drain plug seal.

6. Return the pump to horizontal position.
7. Fill new engine oil from the inlet to the upper limit of the oil level.
8. Tighten the oil filler cap.

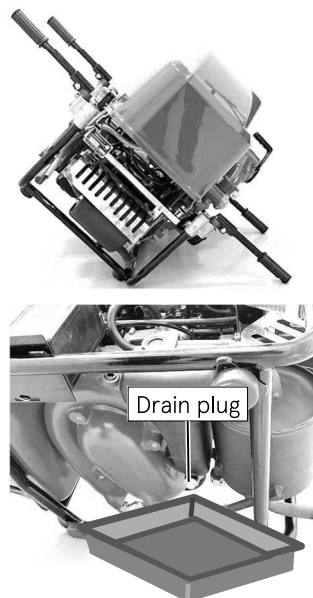

## 15. SERVICE AND MAINTENANCE



- Just after the engine is stopped, the temperature of the engine body and engine oil is high, which may cause burns. Change the engine oil after the engine has cooled down sufficiently.
- If the drained oil is milky white, there is a possibility of moisture mixing with (condensation, etc.) inside the engine.



### Spark plug

Check the spark plugs.

1. Remove the plug cap, and remove the spark plug.
2. Check the spark plug for excessive carbon deposits, electrode erosion and check the washer for damage.
3. Clean the electrode of the spark plug using a wire brush or spark plug cleaner.
4. Measure the spark plug gap. If the gap is out of specification, replace the spark plug with the specified spark plug.

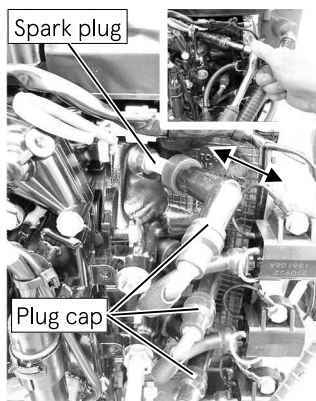

If necessary, adjust the gap to specification.

- Spark plug gap (a) : 0.8–0.9 mm
- Usage limit : 1.2 mm
- Spark plug : NGK DCPR6E

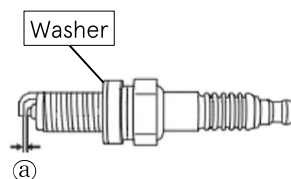

5. Assemble the spark plug as far as (b) by hand. Tighten the plug further to the specified torque using a plug wrench. (c)

- Tightening torque: 18 N·m (13 lb·ft) [1.8 kgf·m]

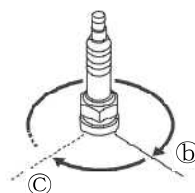

## 15. SERVICE AND MAINTENANCE

### Battery

#### General safety information

Follow the safety instructions on the battery.

When charging a battery, highly explosive oxyhydrogen gas mixture is produced.

Do not charge a battery in a poorly ventilated place.

Do not smoke near the battery.

#### DANGER

**Injury caused with caustic substances of battery.**

- Always wear protective clothing.
- Always wear protective gloves.
- Always wear protective glasses.
- Do not tip the battery, acid would come out through the air vents.



### Disposal

Disused batteries should be disposed according to local laws or regulations.

After each operation of the battery, check the voltage. Replace the battery if necessary.

When disconnecting the battery, disconnect the negative (-) terminal of the battery cable first, then disconnect the positive terminal.

#### CAUTION

- There is a risk of injury.
- When handling the battery, be sure to wear safety glasses and protective gloves.

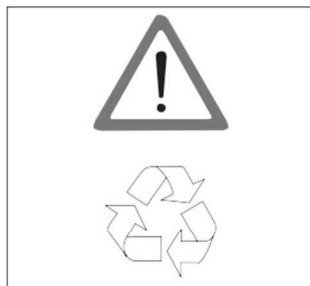

---

## 15. SERVICE AND MAINTENANCE

---

### Electric equipment

Only expert electricians or trained staff members should handle electrical equipment.

Be sure to disconnect battery cables before handling electrical equipment.

When disconnecting the battery cables, first disconnect the negative (-) terminal and then the positive (+) terminal.

When connecting the battery cables, connect the positive (+) terminal first. Next, connect the minus (-) terminal.

Use a fuse with the same rated current (ampere) as the installed fuse. Using a fuse with too high resistance will not protect the electrical equipment and may damage it.

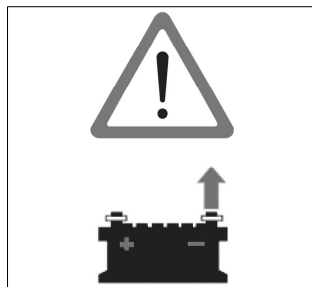

### Fuse

Security fuses are installed in electrical circuits used.

Before replacing the fuse, isolate the cause of the short circuit, and take an appropriate action.

After the appropriate action has been taken, replace the fuse with a new one.

Always have spare fuses available in case of emergency.

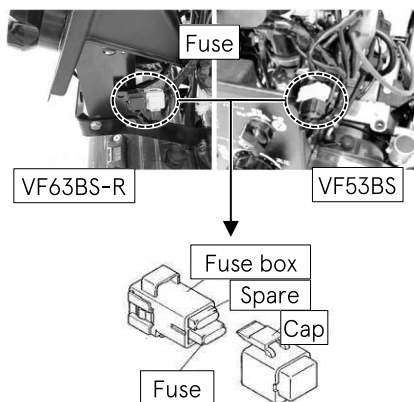

## 15. SERVICE AND MAINTENANCE

### Suction performance and Vacuum leak check

#### CAUTION

- Limit the continuous operation time of the vacuum pump to 30 seconds or less.
- Running the engine at vacuum pump operating speed continuously with no water for more than 30 seconds, may cause the engine overheating. If the engine overheats, wait until it cools down or pump up water and discharge water to cool the engine as soon as possible.
- The water discharge operation allows the cooling water goes into the engine cooling line and circulates in the engine, and then the engine will be cooled down.

1. Close the suction port (with a cap, etc.).

#### NOTE

- Close the suction port not to leak air into the pump.

2. Confirm the drain valves are all closed.



Example of using a suction port cap

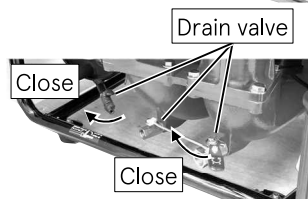

Drain valve

Close

Close

3. Run the engine

#### \_ VF53BS \_

- Turn on the auto suction switch.
- Turn the throttle dial to the start position.
- Start the engine turning the main switch.

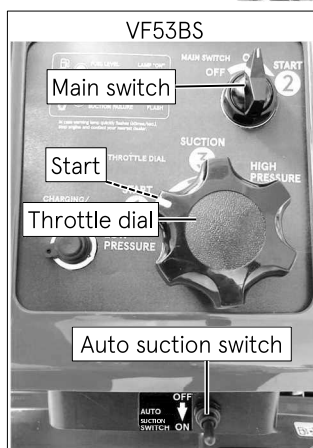

VF53BS

Main switch

Start

Throttle dial

Auto suction switch



## 15. SERVICE AND MAINTENANCE

### VF63BS-R

- Turn on the power and make sure the suction mode switch is set to auto suction.
- Turn the throttle dial to the low-pressure position.
- Start the engine pressing the start switch.

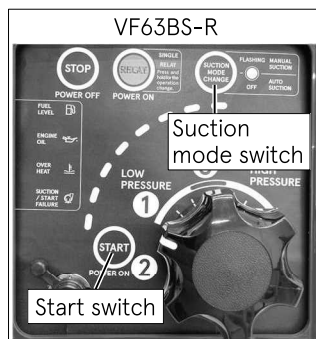

4. Turn the throttle dial to the suction position, then the pump will start to suck up water automatically.

If suction water is not confirmed by the sensor in 30 seconds, the engine will stop automatically. Refer to Chapter 16 TROBLESHOOTING. Then take the appropriate action and check the vacuum leak again.

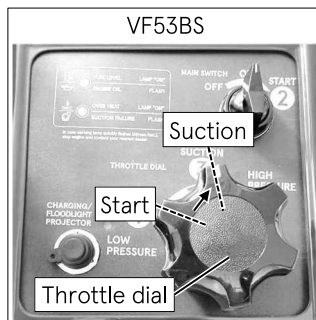

5. Check if the pressure gauge for suction indicates approximately  $-0.08\text{MPa}$  ( $-12\text{psi}$ ).

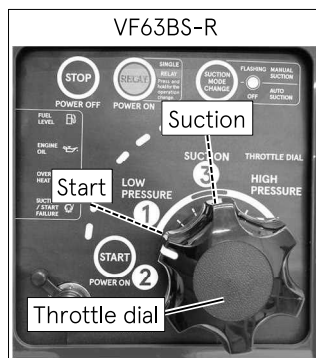

6. Stop the engine and leave it for approximately 30 seconds. Check if the suction pressure is kept the same pressure.

If the vacuum leak is found, refer to Chapter 16 Troubleshooting to eliminate the cause and fix it. Check the vacuum leak does not occur again.



---

## 15. SERVICE AND MAINTENANCE

---

7. Open the drain valves slowly to expose it to the atmosphere, and check that the pointer of the suction pressure gauge returns to "0".

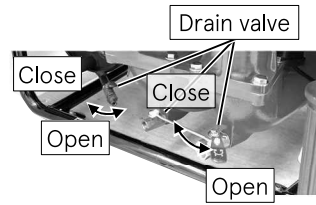

8. Close the drain valves again.

### NOTE

- Before storing the fire pump, flush with fresh water to remove debris from the pump inside. (Especially after using salt water, muddy water, contaminated water, etc.)
- Rubber gaskets, O-rings, seals for the discharge and suction hose fitting wear: Worn rubber seals can cause water leakage, poor vacuum, etc. Frequent inspection of these items is essential.

---

## 15. SERVICE AND MAINTENANCE

---

### Water leak check

1. Attach a suction hose to the suction port.
2. Place the end of the hose into the water more than 30cm deep from the water surface.
3. Close the discharge valve(s) and drain valves.

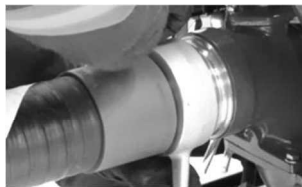

3. Close the discharge valve(s) and drain valves.

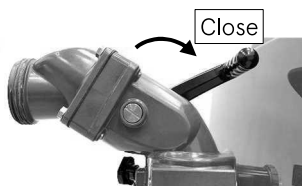

4. Start the engine and suck up water.  
\* In the case of manual operation, pull the manual suction knob.

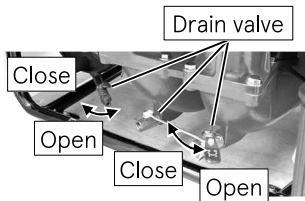

5. Operate the throttle dial to raise the pump pressure to 1MPa (145psi), and then check for water leaks from each part of the pump and the water line.

(Manual operation)

If a water leak is found, refer to Chapter 16 Troubleshooting to eliminate the cause and fix it. Check the vacuum leak will not happen again.



# 16. TROUBLESHOOTING

Typical causes of engine troubles are listed in the following tables.

| Cause                | Trouble                                    |                                      |                              |  |  |                       |  |             |                           |                | Action |                    |                        |                   |                    |              |                         |                      |                             |  |
|----------------------|--|--------------------------------------|------------------------------|--|--|-----------------------|--|-------------|---------------------------|----------------|--------|--------------------|------------------------|-------------------|--------------------|--------------|-------------------------|----------------------|-----------------------------|--|
|                      | Warning lamp flashing                      | Gauge lamp, Warning lamp do not work | Insufficient water discharge |  |  | Water suction failure |  | Air leaking | Vacuum pressure defective | Engine seizing |        | Engine overheating | Engine over-revolution | Poor acceleration | Idling is too high | Rough idling | Engine stumble or stall | Engine start failure | Starter motor does not work | Battery charging failure   |
| Fuel and Lubrication | Fuel shortage                              |                                      |                              |  |  |                       |  |             |                           |                |        |                    |                        |                   | ●                  | ●            |                         |                      |                             | Refuel.  |
|                      | Deterioration of fuel                      |                                      |                              |  |  |                       |  |             |                           |                |        |                    |                        |                   | ●                  | ●            | ●                       |                      |                             | Replace with new fuel.   |
|                      | Fuel tank air vent clogging                |                                      |                              |  |  |                       |  |             |                           |                |        |                    |                        |                   | ●                  | ●            | ●                       |                      |                             | Clean out clogging.  |
|                      | Fuel filter clogging                       |                                      |                              |  |  |                       |  |             |                           |                |        |                    |                        |                   | ●                  | ●            | ●                       |                      |                             | Clean out clogging.  |
|                      | Fuel pump failure                          |                                      |                              |  |  |                       |  |             |                           |                |        |                    |                        |                   | ●                  | ●            | ●                       |                      |                             | Replace.   |
|                      | Injector failure                           |                                      |                              |  |  |                       |  |             |                           |                |        |                    |                        |                   | ●                  | ●            | ●                       |                      |                             | Replace.   |
|                      | Fuel hose kink or snap                     |                                      |                              |  |  |                       |  |             |                           |                |        |                    |                        |                   | ●                  | ●            | ●                       |                      |                             | Fix routing of the hose.   |
|                      | Throttle dial at other than start position |                                      |                              |  |  |                       |  |             |                           |                |        |                    |                        |                   |                    | ●            |                         |                      |                             | Turn dial to start position.   |
| Oil filter clogging  |  |                                      |                              |  |  |                       |  |             |                           |                |        |                    |                        |                   |                    | ●            |                         |                      | ●                           | Replace oil filter. (Do not fill it up with the different brand of oil.) |



## 16. TROUBLESHOOTING

| Trouble    |                       | Cause |   | Action |  |                                      |
|------------|-----------------------|-------|---|--------|--|--------------------------------------|
|            |                       |       |   |        |  | Action                               |
| Electrical | 15A fuse blown        | ●     |   | ●      | Replace with spare fuse.<br>If the fuse blows repeatedly, check a cause, for example,<br><b>15A:</b> Battery cable reverse connection, Operation panel components, VP solenoid<br><b>7.5A:</b> Charging connector, |                                      |
|            | 7.5A fuse blown       |       | ● | ●      |  |                                      |
|            | Starter motor failure |       | ● |        | Check terminals, cords, and screws. Replace parts if necessary.  |                                      |
|            | Control panel failure | ●     | ● | ●      | Check input of starter solenoid. (Equal to control panel output.) Possible electronic board failure. Replace parts if necessary.   |                                      |
|            |                       |       |   |        |  | Warning lamp flashing                |
|            |                       |       |   |        |  | Gauge lamp, Warning lamp do not work |
|            |                       |       |   |        |  | Caused by engine unit                |
|            |                       |       |   |        |  | Caused by playpipe                   |
|            |                       |       |   |        |  | Caused by pump unit                  |
|            |                       |       |   |        |  | Caused by suction                    |
|            |                       |       |   |        |  | Water suction failure                |
|            |                       |       |   |        |  | Air leaking                          |
|            |                       |       |   |        |  | Vacuum pressure defective            |
|            |                       |       |   |        |  | Engine seizing                       |
|            |                       |       |   |        | Engine overheating   |                                      |
|            |                       |       |   |        | Engine over - revolution   |                                      |
|            |                       |       |   |        | Poor acceleration  |                                      |
|            |                       |       |   |        | Idling is too high   |                                      |
|            |                       |       |   |        | Rough idling   |                                      |
|            |                       |       |   |        | Engine stumble or stall  |                                      |
|            |                       |       |   |        | Engine start failure   |                                      |
|            |                       |       |   |        | Starter motor does not work  |                                      |
|            |                       |       |   |        | Battery charging failure   |                                      |

## 16. TROUBLESHOOTING

| Trouble                     |  | Cause  |   | Action              |   |  |
|-----------------------------|--|--|---|---------------------|---|--|
| Compression                 | Piston, piston ring or cylinder worn excessively | ●  |   | Correct or replace. |   |  |
|                             | Carbon deposition in the combustion chamber      |  | ● | Clean out.          |   |  |
|                             | Suction  | Suction height too high or length too long                 |   |                     | Place the pump nearer and/or lower position.                      |  |
|                             |  | Suction hose end is not in water                           |   |                     | Put the end of suction hose below 30cm from the surface of water. |  |
|                             |  | Suction hose coupling loose or gasket failure              |   |                     | Clean the gasket, replace it if necessary. Tighten securely.      |  |
|                             |  | Suction hose strainer clogged with dead leaf or waste etc. |   |                     | Clean out.  |  |
|                             |  | Suction hose cracking or lining peeling off                |   |                     | Repair or replace.  |  |
|                             | Warning lamp flashing                            |  |   |                     |   |  |
|                             | Gauge lamp, Warning lamp do not work             | ●  |   |                     |   |  |
|                             | Insufficient water discharge                     | Caused by engine unit                                      |   |                     |   |  |
| Caused by playpipe          |  |  |   |                     |   |  |
| Caused by pump unit         |  |  |   |                     |   |  |
| Water suction failure       | Caused by suction                                |  |   |                     |   |  |
|                             | Air leaking                                      |  |   |                     |   |  |
| Vacuum pressure defective   |  |  |   |                     |   |  |
| Engine seizing              | ●  |  |   |                     |   |  |
| Engine overheating          |  |  |   |                     |   |  |
| Engine over - revolution    |  |  |   |                     |   |  |
| Poor acceleration           | ●  |  |   |                     |   |  |
| Idling is too high          |  |  |   |                     |   |  |
| Rough idling                |  |  |   |                     |   |  |
| Engine stumble or stall     | ●  |  |   |                     |   |  |
| Engine start failure        | ●  |  |   |                     |   |  |
| Starter motor does not work |  |  |   |                     |   |  |
| Battery charging failure    |  |  |   |                     |   |  |

# 16. TROUBLESHOOTING

| Trouble                            |  | Cause                                |  | Action  |                                      |  |                              |  |                              |                        |  |                       |  |          |                                 |  |                     |  |                    |                                  |  |                     |  |          |                         |  |                   |  |            |                      |  |                       |  |          |                             |  |             |  |            |                          |  |                           |  |          |             |  |
|------------------------------------|--|--------------------------------------|--|---|--------------------------------------|--|------------------------------|--|------------------------------|------------------------|--|-----------------------|--|----------|---------------------------------|--|---------------------|--|--------------------|----------------------------------|--|---------------------|--|----------|-------------------------|--|-------------------|--|------------|----------------------|--|-----------------------|--|----------|-----------------------------|--|-------------|--|------------|--------------------------|--|---------------------------|--|----------|-------------|--|
|                                    |  |                                      |  |   |                                      |  | Action                       |  |                              |                        |  |                       |  |          |                                 |  |                     |  |                    |                                  |  |                     |  |          |                         |  |                   |  |            |                      |  |                       |  |          |                             |  |             |  |            |                          |  |                           |  |          |             |  |
| Warning lamp flashing              |  | Gauge lamp, Warning lamp do not work |  | Tighten securely a clamp of vacuum pipe or replace. |                                      |  |                              |  |                              |                        |  |                       |  |          |                                 |  |                     |  |                    |                                  |  |                     |  |          |                         |  |                   |  |            |                      |  |                       |  |          |                             |  |             |  |            |                          |  |                           |  |          |             |  |
|                                    |  |                                      |  |   |                                      |  | Insufficient water discharge |  | Tighten securely or replace. |                        |  |                       |  |          |                                 |  |                     |  |                    |                                  |  |                     |  |          |                         |  |                   |  |            |                      |  |                       |  |          |                             |  |             |  |            |                          |  |                           |  |          |             |  |
|                                    |  |                                      |  |   |                                      |  |                              |  |                              |                        |  | Caused by engine unit |  | Replace. |                                 |  |                     |  |                    |                                  |  |                     |  |          |                         |  |                   |  |            |                      |  |                       |  |          |                             |  |             |  |            |                          |  |                           |  |          |             |  |
|                                    |  |                                      |  |   |                                      |  |                              |  |                              |                        |  |                       |  |          |                                 |  | Caused by play/pipe |  | Repair or replace. |                                  |  |                     |  |          |                         |  |                   |  |            |                      |  |                       |  |          |                             |  |             |  |            |                          |  |                           |  |          |             |  |
|                                    |  |                                      |  |   |                                      |  |                              |  |                              |                        |  |                       |  |          |                                 |  |                     |  |                    |                                  |  | Caused by pump unit |  | Replace. |                         |  |                   |  |            |                      |  |                       |  |          |                             |  |             |  |            |                          |  |                           |  |          |             |  |
|                                    |  |                                      |  |   |                                      |  |                              |  |                              |                        |  |                       |  |          |                                 |  |                     |  |                    |                                  |  |                     |  |          |                         |  | Caused by suction |  | Clean out. |                      |  |                       |  |          |                             |  |             |  |            |                          |  |                           |  |          |             |  |
|                                    |  |                                      |  |   |                                      |  |                              |  |                              |                        |  |                       |  |          |                                 |  |                     |  |                    |                                  |  |                     |  |          |                         |  |                   |  |            |                      |  | Water suction failure |  | Replace. |                             |  |             |  |            |                          |  |                           |  |          |             |  |
|                                    |  |                                      |  |   |                                      |  |                              |  |                              |                        |  |                       |  |          |                                 |  |                     |  |                    |                                  |  |                     |  |          |                         |  |                   |  |            |                      |  |                       |  |          |                             |  | Air leaking |  | Clean out. |                          |  |                           |  |          |             |  |
|                                    |  |                                      |  |   |                                      |  |                              |  |                              |                        |  |                       |  |          |                                 |  |                     |  |                    |                                  |  |                     |  |          |                         |  |                   |  |            |                      |  |                       |  |          |                             |  |             |  |            |                          |  | Vacuum pressure defective |  | Replace. |             |  |
|                                    |  |                                      |  |   |                                      |  |                              |  |                              |                        |  |                       |  |          |                                 |  |                     |  |                    |                                  |  |                     |  |          |                         |  |                   |  |            |                      |  |                       |  |          |                             |  |             |  |            |                          |  |                           |  |          |             |  |
| Engine overheating                 |  | Replace.                             |  |   |                                      |  |                              |  |                              |                        |  |                       |  |          |                                 |  |                     |  |                    |                                  |  |                     |  |          |                         |  |                   |  |            |                      |  |                       |  |          |                             |  |             |  |            |                          |  |                           |  |          |             |  |
|                                    |  |                                      |  |   | Engine over - revolution             |  | Replace.                     |  |                              |                        |  |                       |  |          |                                 |  |                     |  |                    |                                  |  |                     |  |          |                         |  |                   |  |            |                      |  |                       |  |          |                             |  |             |  |            |                          |  |                           |  |          |             |  |
|                                    |  |                                      |  |   |                                      |  |                              |  |                              | Poor acceleration      |  | Replace.              |  |          |                                 |  |                     |  |                    |                                  |  |                     |  |          |                         |  |                   |  |            |                      |  |                       |  |          |                             |  |             |  |            |                          |  |                           |  |          |             |  |
|                                    |  |                                      |  |   |                                      |  |                              |  |                              |                        |  |                       |  |          | Idling is too high              |  | Replace.            |  |                    |                                  |  |                     |  |          |                         |  |                   |  |            |                      |  |                       |  |          |                             |  |             |  |            |                          |  |                           |  |          |             |  |
|                                    |  |                                      |  |   |                                      |  |                              |  |                              |                        |  |                       |  |          |                                 |  |                     |  |                    | Rough idling                     |  | Replace.            |  |          |                         |  |                   |  |            |                      |  |                       |  |          |                             |  |             |  |            |                          |  |                           |  |          |             |  |
|                                    |  |                                      |  |   |                                      |  |                              |  |                              |                        |  |                       |  |          |                                 |  |                     |  |                    |                                  |  |                     |  |          | Engine stumble or stall |  | Replace.          |  |            |                      |  |                       |  |          |                             |  |             |  |            |                          |  |                           |  |          |             |  |
|                                    |  |                                      |  |   |                                      |  |                              |  |                              |                        |  |                       |  |          |                                 |  |                     |  |                    |                                  |  |                     |  |          |                         |  |                   |  |            | Engine start failure |  | Replace.              |  |          |                             |  |             |  |            |                          |  |                           |  |          |             |  |
|                                    |  |                                      |  |   |                                      |  |                              |  |                              |                        |  |                       |  |          |                                 |  |                     |  |                    |                                  |  |                     |  |          |                         |  |                   |  |            |                      |  |                       |  |          | Starter motor does not work |  | Replace.    |  |            |                          |  |                           |  |          |             |  |
|                                    |  |                                      |  |   |                                      |  |                              |  |                              |                        |  |                       |  |          |                                 |  |                     |  |                    |                                  |  |                     |  |          |                         |  |                   |  |            |                      |  |                       |  |          |                             |  |             |  |            | Battery charging failure |  | Replace.                  |  |          |             |  |
|                                    |  |                                      |  |   |                                      |  |                              |  |                              |                        |  |                       |  |          |                                 |  |                     |  |                    |                                  |  |                     |  |          |                         |  |                   |  |            |                      |  |                       |  |          |                             |  |             |  |            |                          |  |                           |  |          | Vacuum Pump |  |
| Vacuum pipe loose or cracking      |  | Replace.                             |  |   |                                      |  |                              |  |                              |                        |  |                       |  |          |                                 |  |                     |  |                    |                                  |  |                     |  |          |                         |  |                   |  |            |                      |  |                       |  |          |                             |  |             |  |            |                          |  |                           |  |          |             |  |
|                                    |  |                                      |  |   | Strainer cap loose or O-ring failure |  | Replace.                     |  |                              |                        |  |                       |  |          |                                 |  |                     |  |                    |                                  |  |                     |  |          |                         |  |                   |  |            |                      |  |                       |  |          |                             |  |             |  |            |                          |  |                           |  |          |             |  |
|                                    |  |                                      |  |   |                                      |  |                              |  |                              | V-belt damaged or worn |  | Replace.              |  |          |                                 |  |                     |  |                    |                                  |  |                     |  |          |                         |  |                   |  |            |                      |  |                       |  |          |                             |  |             |  |            |                          |  |                           |  |          |             |  |
|                                    |  |                                      |  |   |                                      |  |                              |  |                              |                        |  |                       |  |          | Vacuum pump rotor shaft seizing |  | Replace.            |  |                    |                                  |  |                     |  |          |                         |  |                   |  |            |                      |  |                       |  |          |                             |  |             |  |            |                          |  |                           |  |          |             |  |
|                                    |  |                                      |  |   |                                      |  |                              |  |                              |                        |  |                       |  |          |                                 |  |                     |  |                    | Vane, Side plate worn or damaged |  | Replace.            |  |          |                         |  |                   |  |            |                      |  |                       |  |          |                             |  |             |  |            |                          |  |                           |  |          |             |  |
| Water stop valve                   |  | Replace.                             |  |   |                                      |  |                              |  |                              |                        |  |                       |  |          |                                 |  |                     |  |                    |                                  |  |                     |  |          |                         |  |                   |  |            |                      |  |                       |  |          |                             |  |             |  |            |                          |  |                           |  |          |             |  |
|                                    |  |                                      |  |   | Water stop valve contamination       |  | Replace.                     |  |                              |                        |  |                       |  |          |                                 |  |                     |  |                    |                                  |  |                     |  |          |                         |  |                   |  |            |                      |  |                       |  |          |                             |  |             |  |            |                          |  |                           |  |          |             |  |
| Water stop valve diaphragm failure |  | Replace.                             |  |   |                                      |  |                              |  |                              |                        |  |                       |  |          |                                 |  |                     |  |                    |                                  |  |                     |  |          |                         |  |                   |  |            |                      |  |                       |  |          |                             |  |             |  |            |                          |  |                           |  |          |             |  |





---

## 17. APPENDIX

---

### Tightening torque specifications

|                |       | M4   | M5   | M6   | M8  | M10 |
|----------------|-------|------|------|------|-----|-----|
| Standard Bolt  | N·m   | 1.5  | 3    | 6    | 13  | 27  |
|                | kgf·m | 0.15 | 0.3  | 0.6  | 1.3 | 2.7 |
| Standard Screw | N·m   | 1.5  | 2.5  | 3.5  | 4.5 | -   |
|                | kgf·m | 0.15 | 0.25 | 0.35 | 0.5 | -   |

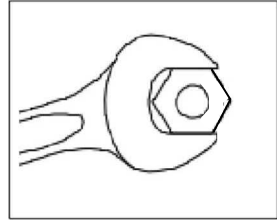

---

## 18. TOOL AND STANDARD ACCESSORY

---

### Standard accessory

| Description             | Remarks    | Quantity |
|-------------------------|------------|----------|
| Tool kit                |            | 1        |
| • Tool kit bag          |            | 1        |
| • Plug wrench           |            | 1        |
| • Handle of plug wrench |            | 1        |
| Spark plug              | NGK DCPR6E | 1        |
| Pumping plate           |            | 2        |
| Fuse *                  | 15A        | 1        |
|                         | 7.5A       | 1        |
| Vinyl pipe              |            | 1        |
| Auto battery charger    |            | 1        |

\* Spare fuses are attached in the fuse boxes.

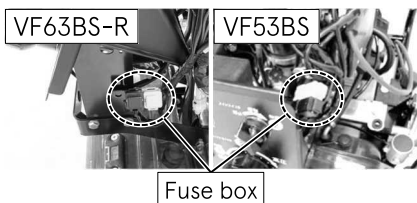

# OWNER'S MANUAL

VF53BS  
VF63BS-R

PORTABLE  
FIRE PUMP

No.003-12099-3

## TOHATSU CORPORATION

5-4, Azusawa 3-Chome, Itabashi-Ku  
Tokyo 174-0051, Japan  
Phone: +81-3-3966-3137