

# OWNER'S MANUAL



## VC52AS VC72AS

PORTABLE  
FIRE PUMP

No.003-12054-3

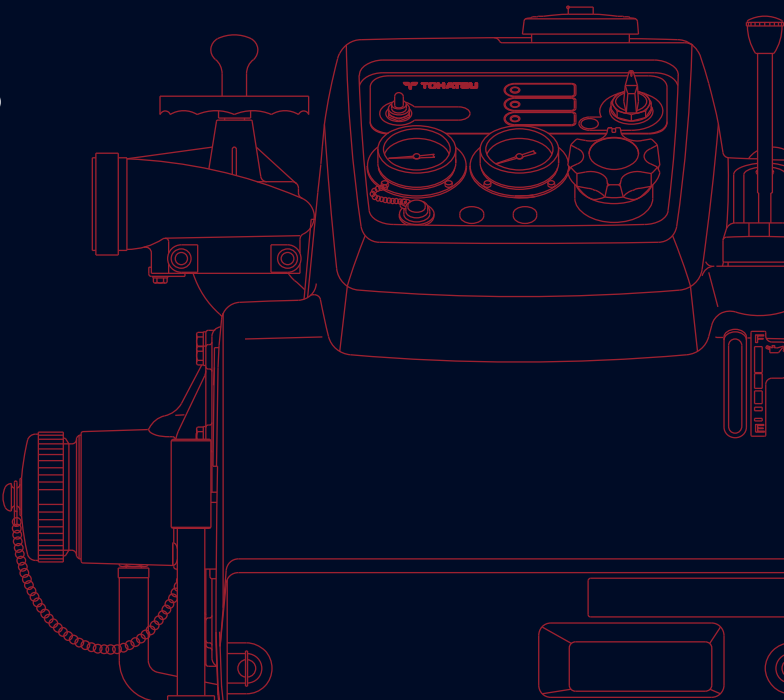

Copyright © 2020 Tohatsu Corporation. All rights reserved. No part of this manual may be reproduced or transmitted in any form or by any means without the express written permission of Tohatsu Corporation.

---

# APPLICATIONS OF THIS FIRE PUMP

---

## **USAGE**

TOHATSU fire pumps “VC52AS, VC72AS” are manufactured for use in firefighting operations.

These portable fire pumps are intended only for firefighting activities in collaboration with general public fire extinguishing equipment.

Using it for other applications is regarded as being used for improper purposes.

The manufacturer of these fire pumps bears no responsibility for any damages that may result from modification of the fire pump without prior permission from the manufacture, improper use of the fire pump, or use of the fire pump for applications other than those stated above.

Note that the use of these fire pumps for applications other than those stated above can result in personal injury or damage to the equipment.

Using the fire pump within the range of intended uses implies that the user should follow the instructions provided by the manufacturer relevant to operation, servicing and maintenance.

## Intended people

All persons who operate, service or maintain the fire pump must read and understand the following items:

- Owner's manual
- Safety-related instructions on the pump and the other parts such as the battery.
- The other owner's manuals, such as battery charger.

The portable fire pump should be operated by only persons who received training as operators of fire engines along with each country's (region's) regulations.

The range of personal responsibility and supervision must be strictly defined by the user.

If a person does not have adequate professional knowledge required for his/her assignment, he/she must undergo relevant training or receive appropriate instructions from an individual who is actually knowledgeable in operation of the fire pump.

A person who does not have enough knowledge is not permitted to operate the fire pump.

When using the fire pump, conditions under which an explosion may occur are not considered.



- **Keep this manual in a safe place for future reference.**
- **Operators of this fire pump must always refer to all the relevant manuals in order to avoid errors, personal injuries, and equipment damage when operating the portable fire pump, and to maintain faultless operation.**
- **Arrange owner's manual so that operators can refer to them where they operate the fire pump.**

---

# INTRODUCTION

---

Thank you for purchasing the TOHATSU Fire Pump.

This fire pump has passed a range of quality assurance standards.

## **Owner's manual**

The portable fire pump complies with relevant laws and regulations.

The manual includes a description for operation and maintenance. Before using this fire pump, be sure to read and understand the manual thoroughly.

## **Engine operation**

This manual also includes a description for operation and maintenance of the engine.

<b>NOTE</b>
-------------

- The manual is an important item that goes with your portable fire pump.
- This manual should accompany this fire pump if sold to another person.

Before using this fire pump, write down the serial number in the following boxes. It will be useful in the case of asking about servicing, repairs and genuine parts.

Serial Number

The pump serial number (identification number) is marked on the pump casing.

VC52AS  
VC72AS



← 

--	--	--	--	--	--

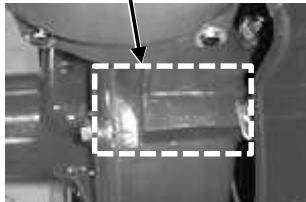

## GENERAL SAFETY INFORMATION

### Overview

Before operating the TOHATSU fire pump thoroughly read this manual to understand the proper operating procedures including “DANGER”, “WARNING”, “CAUTION” and “NOTE”.

These notices are designed to bring attention to very important information necessary to ensure safe, trouble free operation.



### Warning sign

#### Meaning

This sign is used for safety-related instructions in this manual.

Be sure to follow all safety-related instructions, otherwise, personal injury may occur.



### Signal words



• Failure to observe will result in severe personal injury or death.



• Failure to observe could result in severe personal injury or death.



• Failure to observe could result in personal injury or property damage.

- This instruction provides special information to facilitate the use or maintenance of the pump or to clarify important points.
- For attaching position of the warning label, refer to the “CONTENT 3. LABELS”.
- **Warning labels should be read clearly at any time.**

**If the display of the warning label becomes difficult to be read, it was almost come off, you must replace paste immediately.**

### Safety-related instructions and warning signs

Read and follow the safety-related instructions described in this manual and all warning signs on the portable fire pump thoroughly.

Always keep the warning signs in a legible condition. If any warning sign becomes illegible or detached, replace it immediately.

## Transporting the portable fire pump

### CAUTION

- Retractable handle is folding type.
- Do not put hand or finger between top of retractable handle and bracket.
- When transporting the portable fire pump, assign one person per handle.
- Also, when you transport the portable fire pump, it should be transported holding the handle firmly.
- There is a risk of injury to the leg by fall.



## Durability of protection

When you purchase a new pump, it is placed in packing box and protected.

## Storage of pump after transportation

Keep the pump away from high humidity, and place it on a horizontal plane.

## Disposal of packing box

Dispose the packing box by following the environmental laws.

## Noise

### CAUTION

- Wear proper hearing protection during operation.



## Exhaust gas

Fatal hazard from carbon monoxide (CO) poisoning

Exhaust gas emitted from the engine contains carbon monoxide (CO) etc. that may seriously affect human health.

Do not operate the engine in a room, car, warehouse, tunnel or other closed locations that have poor ventilation.





## Safety devices

Before operating the portable fire pump, be sure to check that all the safety devices have been installed in the appropriate positions.

Before removing the safety devices, turn the main switch off.



After protective devices (such as the muffler guard) have been disassembled as part of servicing and maintenance work, immediately install them back to their original locations, making sure that they are in safe and secure condition.



Check the portable fire pump visually and functionally on a regular basis.

If you find any faulty device or equipment, remove it immediately, and repair or replace it, if necessary. Failure to do so may cause an accident.

After it has been repaired or replaced, make sure that it functions correctly.



## Protective clothing, Protective equipment

During fire extinguishing training or regular firefighting services, wear normal protective clothing and equipment to protect your body.

- Fireproof protective clothing
- Fireproof helmet
- Fireproof protective gloves
- Fireproof protective boots



## Service, Maintenance

Servicing and maintenance of this fire pump must be carried out by only the persons who have professional knowledge, who are familiar with the device, and who understand laws and regulations regarding safety and accident prevention.

Before starting maintenance work, turn the main switch off to stop the engine.

Disconnect the negative terminal of the battery.

Before starting maintenance work, securely place the portable fire pump on the ground.

In the case of just after stopping the engine, do not touch the exhaust pipe, the muffler and the other engine parts until these parts will be cold enough. These parts could be very hot and will cause severe burns.



## Electrical equipment

Only expert electricians or trained staff members should handle electrical equipment.

When disconnecting the cable from the battery, disconnect the negative (-) cable first.

When connecting the cable to the battery, be sure to connect the positive (+) cable first. After that, connect the negative (-) cable.

Do not place any metal on the top of or around the battery. Doing so may cause a short circuit.

Use a fuse with the same specifications as the original one when replacing it. Using a fuse that has a greater capacity than the rated value may damage the equipment.

Check the electrical equipment of the fire pump on a regular basis.

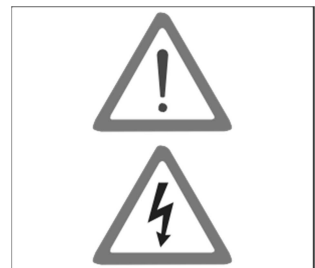
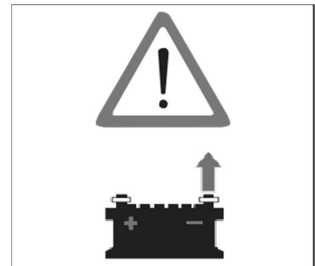

## Battery

Follow any safety-related instructions shown on the battery.

The battery can generate flammable hydrogen gas that may **cause an explosion**.

Do not charge the battery in closed location.

Do not smoke around the battery.

The battery electrolyte is **caustic and may cause personal injuries**.

- Always wear protective clothing.
- Always wear protective gloves.
- Always wear protective glasses.
- Do not tilt the battery. Doing so may cause the battery electrolyte to leak out from the vent hole.



## Handling of fuel

Exercise care when handling fuel. Failure to do so may cause fire.

Do not bring any flames near fuel. Stop the engine before refueling. Do not smoke while refueling fuel.

Do not refill fuel in an enclosed room. Doing so may cause an explosion caused by fuel fumes.

If fuel spills, wipe it with a cloth or other material, and dispose of it according to relevant laws and regulations.



## Disposal

Dispose of disused batteries according to relevant laws and regulations.



## Genuine parts

When replacing parts for servicing and maintenance of portable fire pumps, be sure to use only Tohatsu genuine parts.

If genuine Tohatsu parts and accessories are not used, it may adversely affect the functioning and safety of the fire pump. Use genuine Tohatsu parts only.

Tohatsu bears no responsibility for any personal injuries or equipment damage that may result from use of parts or accessories obtained from outside sources.

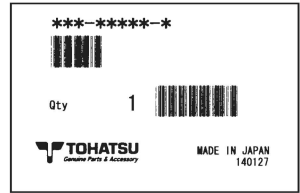

## Environmental protection measures

Dispose of oil, fuel, batteries, etc. according to relevant environmental laws.

Do not dump waste into the ground, water, or sewerage.

Store the fuel only in the specified container.

When disposing of parts, follow the correct disposal procedure.



## Water-prohibiting substance

Do not discharge water to water-prohibited substance.

## Use of water

Do not pump combustible liquids, chemical or caustic liquids.

---

## CONTENTS

---

1. SPECIFICATIONS.....	1
2. OPERATION DEVICE.....	5
3. LABELS.....	7
4. OPERATING PRECAUTIONS.....	8
5. DESCRIPTION OF DEVICES.....	10
6. PREPARATION FOR OPERATION.....	21
7. USE OF OPERATION PANEL.....	26
8. STARTING THE ENGINE.....	29
9. PRIME AND DISCHARGE.....	34
10. STOPPING THE ENGINE.....	41
11. MAINTENANCE AFTER OPERATION.....	42
12. MAINTENANCE IN COLD CONDITION.....	49
13. USE OF ACCESSORY.....	54
14. PERIODICAL INSPECTION.....	55
15. SERVICE AND MAINTENANCE.....	58
16. TROUBLESHOOTING.....	69
17. APPENDIX.....	83
18. TOOL AND STANDARD ACCESSORY.....	84
19. WIRING DIAGRAM.....	85

---

# 1. SPECIFICATIONS

---

Model	VC52AS	VC72AS
Description	Portable pump	
Engine		
Manufacturer	TOHATSU CORPORATION	
Model	2WT76AM	
Type	2-stroke, water-cooled spark ignition engine	
Bore xStroke	76 mm x 68 mm (2.99 in x 2.68 in)	
Number of Cylinder	2	
Piston displacement	617 cm <sup>3</sup>	
Authorized output	30kW (40.8PS)	
Fuel type	Unleaded petrol RON91	
Fuel tank capacity	18 L (4.76gal(US))	
Fuel consumption	9 L/h (2.38gal(US)/h)	13 L/h (3.43gal(US)/h)
Engine oil tank capacity	1.6 L (0.42gal(US))	
Ignition	C.D.I.	
Spark plug	NGK BPR7HS-10	
Starting system	Electric starter and Manual starter	
Lubrication	Auto mixing	
Fuel system	Carburetor	
Battery	12V-16 Ah/5 h, 12V-18 Ah/10 h	
Flooding bulb	12V-35W	

# 1. SPECIFICATIONS

Model	VC52AS	VC72AS
<b>Primer</b>		
Type	Rotary-vane vacuum pump (Oil less type)	
Max. suction height	Approx. 9 m (29.5 ft)	
<b>Pump</b>		
Type	Single suction, single stage, centrifugal pump	
Number of delivery outlet	1	
Discharge port coupling	BSP thread 2-1/2" (male) JIS fire thread (B-9912) 2-1/2" (male)	
Suction port coupling	BSP thread 4" (male), 4-1/2" (male) JIS fire thread (B-9912), 3" (male), 3-1/2" (male)	
Pump performance (Suction height: 3 m / 9.8 ft)	1.45 m <sup>3</sup> /min at 0.5 MPa 380 gal(US)/min at 75 psi	1.43 m <sup>3</sup> /min at 0.7 MPa 375 gal(US)/min at 100 psi
	1.15 m <sup>3</sup> /min at 0.7 MPa 300 gal(US)/min at 100 psi	1.02 m <sup>3</sup> /min at 1.0 MPa 265 gal(US)/min at 150 psi
<b>Dimensions and weight</b>		
Length×Width×Height	700 × 620 × 730 mm (27.6 × 24.4 × 28.7 in)	
Mass (Dry)	85 kg (187 lbs)	

## Materials

<b>Engine</b>	
Crankcase, Cylinder, Cylinder head	Aluminum alloy
Crankshaft	Chromium-molybdenum steel
Connecting rod	Chromium-molybdenum steel
Piston	Aluminum alloy
Pump shaft	Chromium-molybdenum steel
Muffler	Steel
<b>Pump</b>	
Pump casing, Pump cover	Aluminum alloy
Impeller	Aluminum alloy
<b>Shaft seal</b>	
Type	Mechanical seal

# 1. SPECIFICATIONS

## Performance Curve

VC52AS

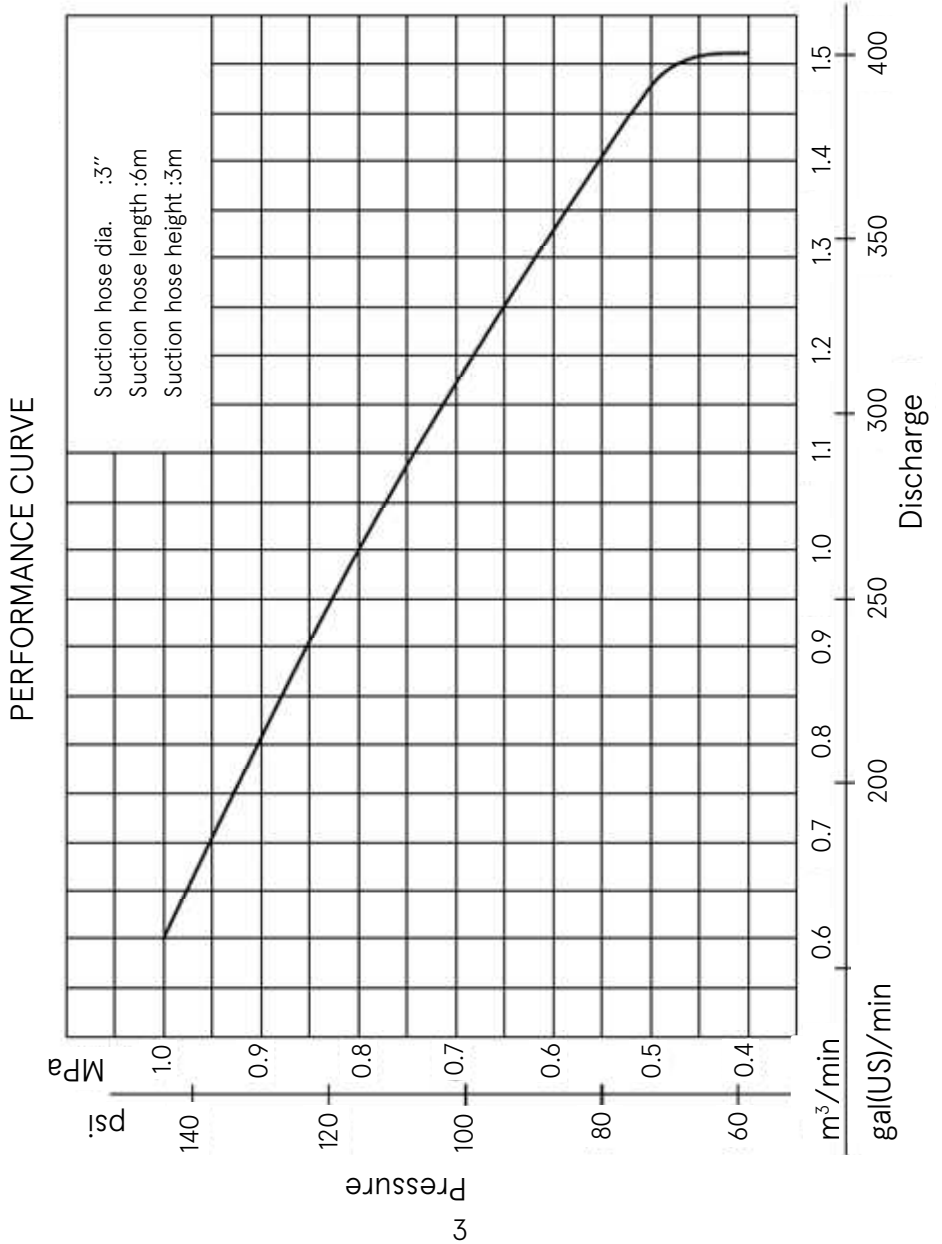



# 1. SPECIFICATIONS

## Performance Curve

VC72AS

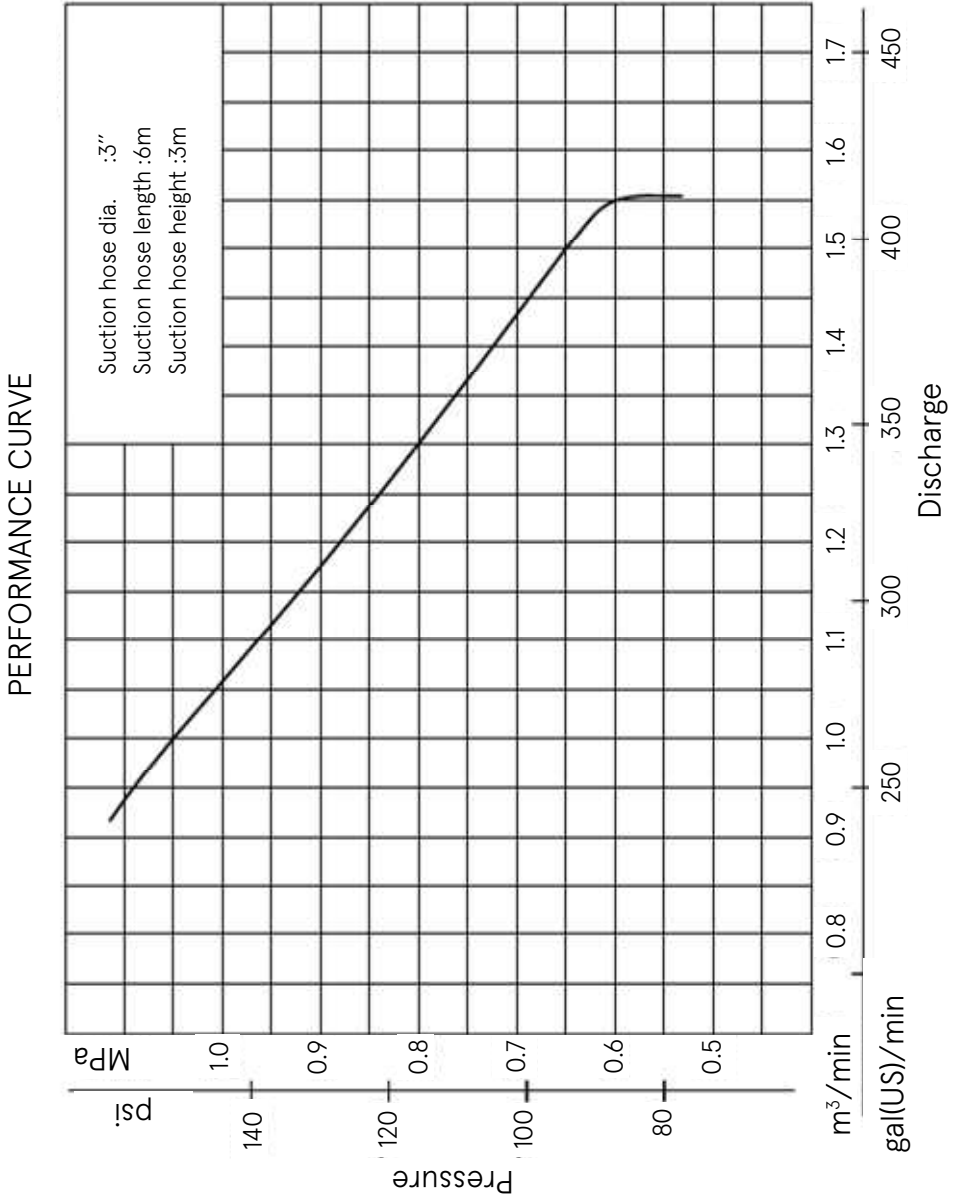

## 2. OPERATION DEVICE

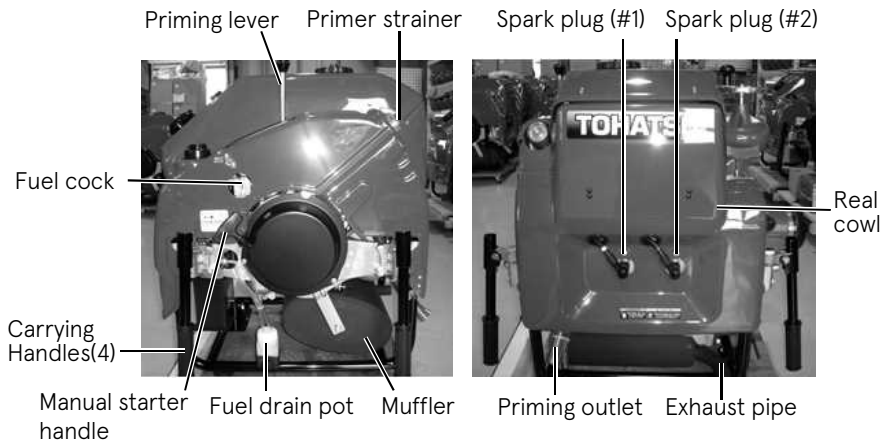
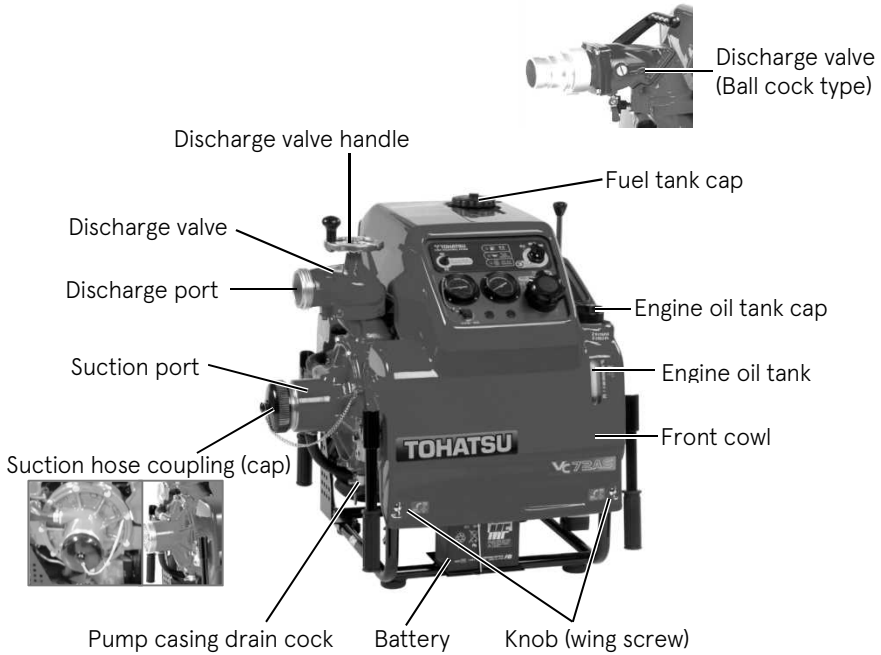

---

## 2. OPERATION DEVICE

---

### Control panel

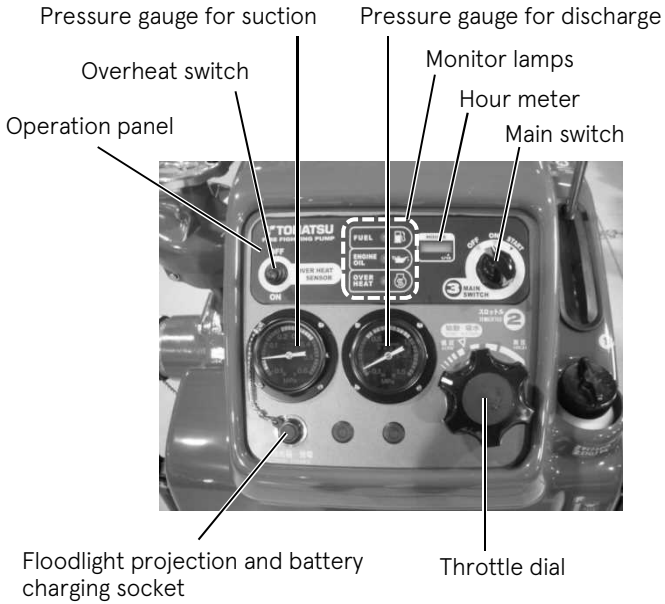

### Operation panel warning lamps

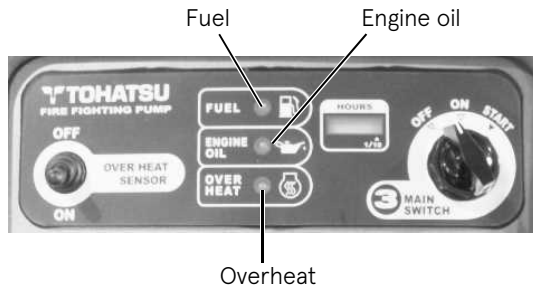

# 3. LABEL

## WARNING & CAUTION

<b>WARNING</b> ■ Read owner's manual very carefully before operating this motor. Give special attention to safety cautions. ■ Never remove or replace the motor cover while the engine is running. (Only for VC series engine.)		■ Check oil level before starting. (Only for VC series engine.) ■ Unloaded fuel only.	■ May cause fire and explosion. - Do not smoke or use open fire near the fuel system. - Stop the engine before filling the fuel tank. - Do not spill fuel.	<b>CAUTION</b> ■ May cause injury of eye. - Always use eye protectors when operating the engine. ■ Exhaust gas may damage you (skin). - Only operate the engine in well-ventilated surroundings.
---	--	--	---	--

<b>WARNING</b> ■ High Voltage : Never touch any electrical parts while the engine is running.	<b>CAUTION</b> ■ Do not touch engine when in operation, and / or immediately upon shut down. It may cause severe injury to you.
--	--

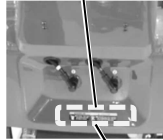

**CAUTION**  
**Risk of burns**  
 - Do not touch a muffler and an exhaust pipe.

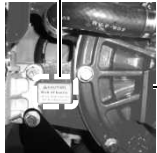

燃料ドレンバルブ FUEL DRAIN VALVE  
 開(引く) / 燃料コックは閉のこと  
 ← OPEN (PULL) / CLOSED FUEL COCK.  
**注意 CAUTION**  
 ● ドレンバルブ内の燃料は直ちに燃料タンクに戻して下さい。  
 ● Return fuel in drainpot to fuel tank immediately.

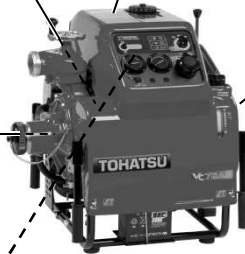

(Pulley for Vacuum pump)  
 On the fuel tank ~ Inside of the cowl

**WARNING**  
 ■ Never touch rotating parts while the engine is running. Severe personal injury will occur.

<b>WARNING</b> ■ High Voltage : Never touch any electrical parts while the engine is running.	<b>CAUTION</b> ■ Do not touch engine when in operation, and / or immediately upon shut down. It may cause severe injury to you.
--	--

---

## 4. OPERATING PRECAUTIONS

---

### Installing pump

 **CAUTION**

- **The fire pump must be installed on a level ground. Otherwise, an accident may occur.**  
**If the fire pump should be installed on uneven ground, it must be secured.**

**NOTE**

- Place the pump as near as possible to water source, and water suction height as low as possible.
- When putting the portable fire pump down to the ground, put it gently and horizontally.
- In case of the inclined location or uneven ground, make sure that water suction hose is located lower than suction port of the pump.
- In case of the suction hose is put undulated, air can be left easily in the hose, and possibly cause suction inability when the water discharge valve is opened.
- In case of the suction inability due to air remaining in the suction hose, set the water discharge valve half-opened, and operate vacuum pump until water is discharged continuously. (for 3 to 5 seconds from beginning of water discharge).
- Be sure to install strainer and basket on the end of suction hose. If the pump may suck sand or mud of the bottom of water source, place sheet below the basket.
- Strainer and basket of suction hose should be placed more than 300 mm (11.8 in) below water surface to prevent suck of air.
- Discharge hose should be arranged not to be bent.

---

## 4. OPERATING PRECAUTIONS

---

 **CAUTION**

- When installing the portable pump in the vehicle, place the vehicle on a level place, and install the pump.
- When installing the portable pump in the vehicle, make sure to apply the brakes of the vehicle in order to stop the wheels. A serious accident may occur if the vehicle moves.
- Do not put your hands or fingers in the retractable part when operating the handle.
- When transporting the portable fire pump, assign one person per handle. Also, when you transport the portable fire pump, it should be transported holding the handle firmly.



Do not put your hands or fingers

**NOTE**

- When lowering the portable fire pump to the ground, lower it gently and horizontally.

 **CAUTION**

- Do not touch the exhaust pipe and the muffler while the engine is running, or for more than 10 minutes after the engine has been stopped. These parts are very hot and will cause severe burns.

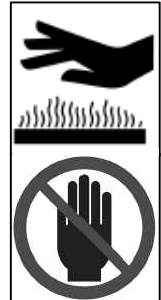

## 5. DESCRIPTION OF DEVICES

### Carrying handle

The fire pump is equipped with four carrying handles. The handles can be folded manually, and opened by rotating them by 90 degrees.

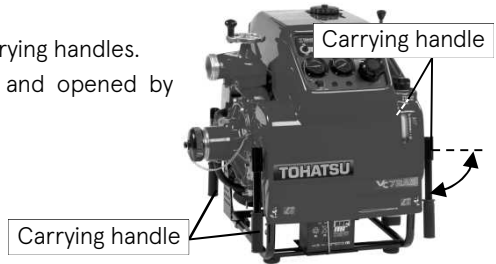

### ⚠ CAUTION

- **Personal injuries may occur when opening or closing the handle.**
- **Do not put your hands or fingers into the retractable part when operating the handle.**
- **To prevent injuries, two persons should work together when carrying and placing the pump.**



### Opening the cowl

#### Front cowl

When you remove the front cowl, turn the 2 wing screws at the front cowl and release the lock on each screw. Release the 2 hooks up at the back side of the pump. Lift the front cowl toward upper side.

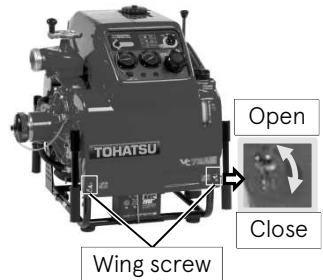

### NOTE

- When removing the cowl, do not use excessive force with care to avoid damaging the hook, cowl or other parts.

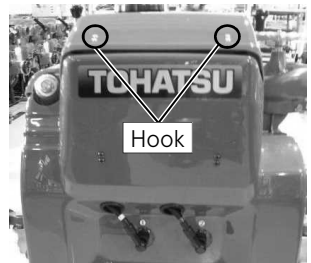
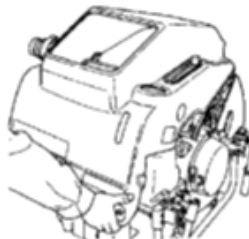

## 5. DESCRIPTION OF DEVICES

### Rear cowl

- When you remove the rear cowl, detach the two plug caps from the spark plugs.
- Pull open the cowl at around the support pin.
- Remove the plug caps through the holes in the cowl.
- Lift the rear cowl toward upper side.

#### NOTE

- Remove the front cowl first, and the rear cowl second.



### Assembling the cowl

Assembling order is in reverse order of the opening. The hooks (at 2 locations on the cowl) must be aligned to sockets of the grommet before insert firmly.

#### NOTE

- Assemble the rear cowl first, and the front cowl second.

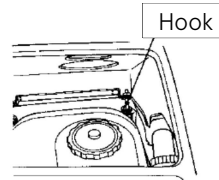
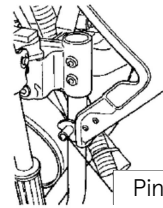

### Suction port

The diameter of the thread for the fire pump is  
BSP thread 4" (male), 4-1/2" (male)  
JIS fire thread (B-9912), 3" (male), 3-1/2" (male)



#### ⚠ WARNING

- When the pump is running, do not put your finger into the suction port, you may be seriously injured by the rotating inducer.

#### ⚠ CAUTION

- If the pump runs without a strainer, gravel may enter the pump, resulting in significantly reduced water discharge capacity.





---

## 5. DESCRIPTION OF DEVICES

---

### Discharge port

The diameter of the thread for the fire pump is

BSP thread 2-1/2" (male)

JIS fire thread (B-9912) 2-1/2" (male)

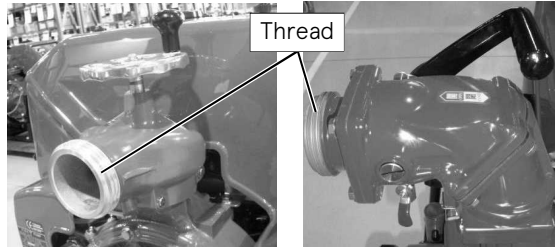

Screw down discharge Valve (Single outlet)

Ball valve discharge Valve (Single outlet)

### Discharge valve

Use the discharge valve handle for opening and closing the discharge valve.

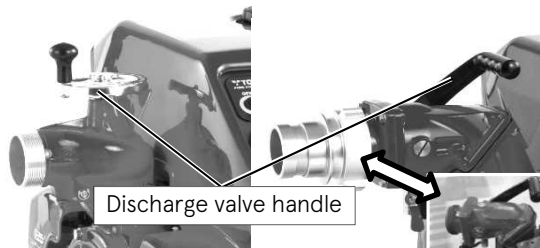

Screw down discharge valve (Single outlet)

Ball valve discharge valve (Single outlet)

---

## 5. DESCRIPTION OF DEVICES

---

### Drain valve

Use the drain valves to drain water.

Drain valves;

- at the pump case
- at the muffler
- at the ball cock discharge valves (Only for ball cock discharge valve type)

**NOTE**

- Close all the valves when operating the fire pump. If the valve is opened, water cannot be suctioned.

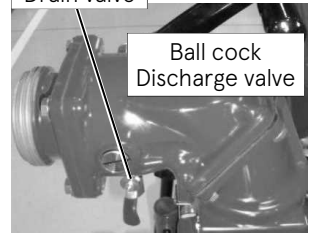
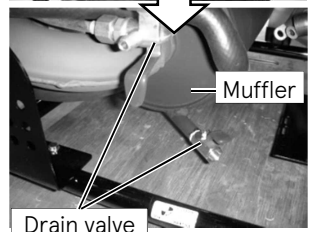
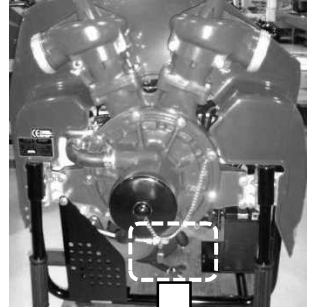

### Priming lever

Use for suctioning water.

After starting the engine, pull down the priming lever to suction water.

After priming has been completed, return the priming lever to its original position.



### Fuel tank

Refill appropriate amount of gasoline to the fuel tank.

Close the fuel tank cap all the time except refuel.



---

## 5. DESCRIPTION OF DEVICES

---

### Engine oil tank

Refill appropriate amount of oil to the oil tank.

Close the Oil tank cap all the time except filling.

The oil tank has an oil level sensor.

The warning buzzer sounds, if the engine oil is not enough filled.

#### **CAUTION**

- **If you run the pump despite of the warning buzzer sounds, the engine could have damages and/or be stuck.**

#### **NOTE**

- Fill the 2-stroke engine oil until the oil level warning buzzer does not sound.

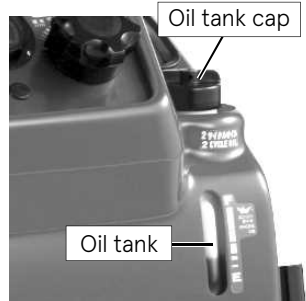

### Fuel valve

Full open or close completely.

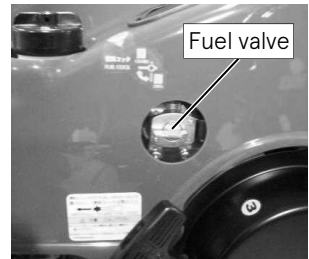

### Control panel

The control panel is equipped with all the necessary operating and control instruments as follows.



### Operation panel

The operation panel is equipped with

- Main switch
- Warning lamp : Fuel, Oil, Over heat
- Hour meter
- Over-heat switch



---

## 5. DESCRIPTION OF DEVICES

---

### Main switch (Stop switch)

Turn the Main switch to run or to stop the pump.

Description    Function

OFF        To stop the pump

ON         Running position

START     To start the pump running

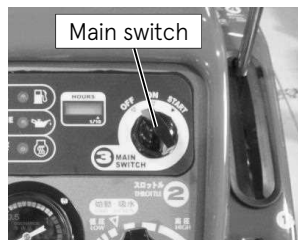

### Warning lamp and Warning buzzer

Turning the start switch “ON” position, if there is no problem in the engine to start, the warning lamps and buzzer are off. If there some problems in the pump, the monitor lamps light on when you turn the start switch on. The warning lamps and the buzzer indicate the following information:

Warning lamp: Fuel, Engine oil, Overheat

Warning buzzer alarms: Engine oil

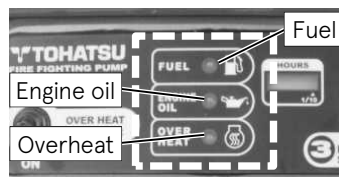

#### CAUTION

- **If they do not, remove the cause by following the content “16 troubleshooting” section.**

-Low fuel level warning

If the fuel level goes down below approximately 1/3 of the fuel tank, monitor lamp lights up.

-Low engine oil warning

If the engine oil level goes down below approximately 1/3 of the engine oil tank, warning lamp lights up and the warning buzzer sound.



#### CAUTION

- **Refill the engine oil immediately. Even if the warning lamp lights up and the buzzer sound, the engine will not stop soon. However, refill the engine oil immediately to avoid the engine stuck risk.**

---

## 5. DESCRIPTION OF DEVICES

---

-Overheat warning

If the engine overheat caused by lack of cooling water, etc. then the overheat lamp lights.

### CAUTION

- **The engine may be damaged. Do not restart the engine soon after stopped running.**

### NOTE

- In the case of the overheat sensor switch is set in "ON" position, the engine stops automatically when an overheated is detected.

### Overheat switch

The overheat sensor switch should be always set in "ON" position to avoid a malfunction or destruction of the engine by overheating.

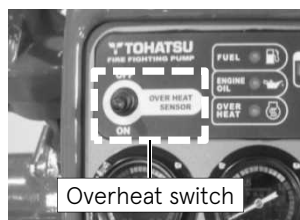

### CAUTION

- **Restarting without treating with the cause of overheating may cause the engine condition become worse or be damaged. In particular, with regard to trouble that occurs in the suction line, cooling line, fuel line and engine itself, remove the cause and then restart the engine.**
- **Make sure that the warning lamp and the buzzer have turned off.**

In the case of the switch "ON", the engine will stop, the lamp turns on and buzzer sound when the overheat sensor works.

In the case of the switch "OFF", the engine will not stop, the lamp turns on and buzzer also sound when the overheat sensor works.

The engine can be started if the switch is at "OFF" position.

### Hour meter

The hour meter indicates the accumulated operation time of the fire pump.

### NOTE

- Use it to check the running time.
- The meter continues counting as long as main switch is "ON"

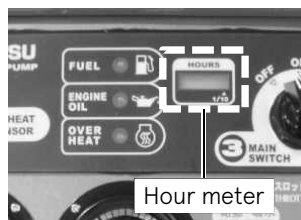

---

## 5. DESCRIPTION OF DEVICES

---

### Throttle dial

Use the Throttle dial to control discharge pressure.



### Pressure gauge for suction

The pressure gauge for suction indicates the actual operating pressure.



### Pressure gauge for discharge

The pressure gauge for discharge indicates the actual operating pressure.



### Battery charger socket

Connect the battery charger plug to the socket when charging the battery of the pump.

<Specifications of accessory socket>

- Voltage: DC12V
- Max. allowable current: 5A

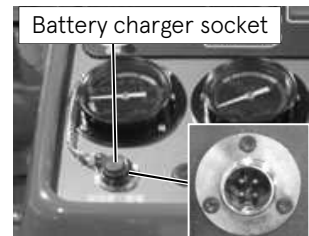

### CAUTION

- **Before charging a battery, turn the main switch OFF.**
- **When starting operation, make sure to remove the battery charger before turning the main switch ON.**
- **The socket is for a battery and a floodlight.**
- **Do not connect a cigarette lighter to the socket, because it is not a heat-resistant object.**

---

## 5. DESCRIPTION OF DEVICES

---

### Fuse box.

Security fuses are installed for electrical circuit in the fuse boxes.

There are two fuse boxes:

- Black color fuse box is for 15A fuse.
- Yellow color fuse box is for 5A fuse.

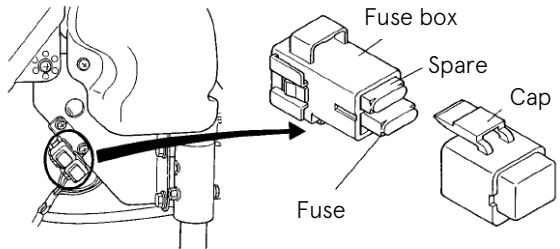
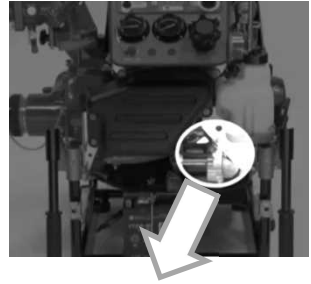

### Manual starter

If the engine does not start with the starter motor, use the manual starter.



- **Do not pull the manual starter handle when the pump is running. Personal injuries may occur and/or the manual starter may be damaged.**



### NOTE

- To start the engine with manual starter, engage the manual starter ratchet by pulling the starter rope slowly. And then pull the starter handle quickly with great force from the position in which feeling harder resistance.



---

## 5. DESCRIPTION OF DEVICES

---

### Governor case

Check the governor oil level with the governor oil level gauge (dipstick).

### Oil level gauge

The governor oil gauge shows upper and lower level on the gauge.

If oil is needed, add 2-cycle engine oil from the oil gauge port up to the full line mark.

Use the engine oil recommended by the engine manufacture.



**CAUTION**

- **Be sure to stop the engine before checking the oil level. If you pull the dipstick when the pump is running, the oil may blow out.**

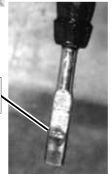
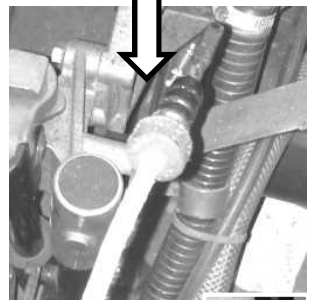

### Mechanical governor

A built-in mechanical governor controls the throttle valve so that the maximum engine speed does not exceed the revolution shown below.

- VC52AS : 5650 r/min
- VC72AS : 5720 r/min



---

## 5. DESCRIPTION OF DEVICES

---

### **Floodlight (Search light)** \*Option

Use the floodlight projector to illuminate the location where this fire pump is operated.

Connect the floodlight plug to the pump side outlet socket.

Fix the projector to the tripod with tightening the adjust screw.

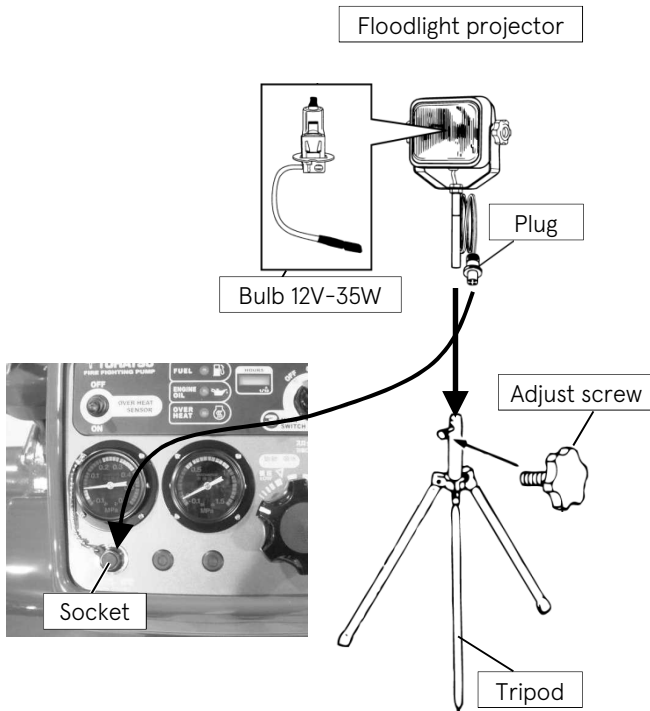

---

## 6. PREPARATION FOR OPERATION

---

### Initial charge of battery

The battery can be used immediately after filling cells with electrolyte.

Do not open the battery after filling it with electrolyte. Because this is maintenance free of electrode. (Sealed type battery)

Refer to the INSTRUCTIONS on the battery.

### Fuel

Fill the tank with gasoline until the maximum level checking by the gauge indicator (in red).

\* Gasoline: 87 octane minimum at pump posted rating  
...91 based on the research octane rating method.

• Fuel tank capacity: 18 L (4.75 gal)



Vaporized fuel may cause ignition or an explosion.

- Do not bring any flames near fuel.
- Smoking, (errant) sparks, static electricity, heat and the other sources of fire can cause explosion.
- Stop the engine before refueling or draining fuel from carburetor.
- Do not spill fuel or overfill fuel into the tank.



---

## 6. PREPARATION FOR OPERATION

---

### CAUTION

- **Do not breathe in vapor!**
- **Petrol fumes are very toxic.**
- **After stopping the engine, do not touch while it is hot.**
- **Refill fuel after the engine has cooled down.**
- **Fuel tank cap should be always tightly closed. Fuel tank cap should be removed only to fill tank with fuel.**
- **Properly clean up all fuel spills (checking for gasoline vapor) before starting engine.**
- **If petrol or fuel spills, wipe it off using a cloth or materials, and dispose of them according to the relevant laws and regulations.**



### NOTE

- Use of low-quality fuel results in a short engine life as well as starting difficulty and other engine problems.
- Fuel containing alcohol, methanol (methyl), or ethanol (ethyl), may cause:
  - Deterioration of rubber parts and plastic parts.
  - Starting, idling and other engine performance problems.
- Do not use fuel that contains more than 10% ethanol or more than 5% methanol.
- Damages resulting from the use of fuel contain alcohol are not covered under the limited warranty.

Keep fuel tank full with gasoline at all times to ensure readiness.

### Governor oil

Before using fire pump, check governor oil level.

Pull out governor oil gauge (dipstick), check the oil level, the oil level should be between upper and lower line on the dipstick. If the oil level is under the lower line, add 2-stroke engine oil from the oil gauge port up to the full line mark.



Full line mark

---

## 6. PREPARATION FOR OPERATION

---

### Engine oil

Refill the 2-stroke engine oil to the oil tank.

\* Fill the oil tank with the engine oil until "F" level.

#### CAUTION

- If the engine oil is not enough filled. The warning buzzer sounds, ( switch "ON") We recommend that you use engine oil of ISO FB grade or higher.
- If different grades of engine oil are mixed, it may gelate, which could cause oil filter clogged.
- Always wipe off spilled engine oil.



#### NOTE

- If the engine oil is not enough (less than approx. 1/3 of the oil tank), the monitor lamp for oil level lights on, and also the warning buzzer sound.

### 2-stroke engine oil

We recommend that you use engine oil of ISO FB grade or higher.

### Oil level sensor

The lamp on the operation panel will light when the level of engine oil goes down to approximately 1/3 of the oil tank. And also the buzzer will sound.



---

## 6. PREPARATION FOR OPERATION

---

### Drain valves

Make sure the all drain valves are closed.

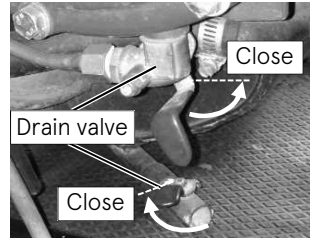

(For ball cock discharge valve)

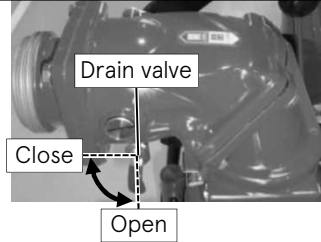

### Discharge valve

Make sure the discharge valve is closed.

In the case of ball cock discharge valve type, also close the drain cock.

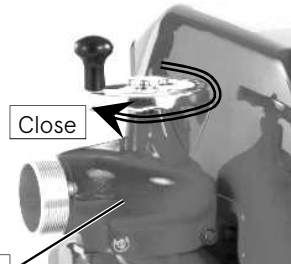

Screw down discharge valve

Ball cock discharge valve

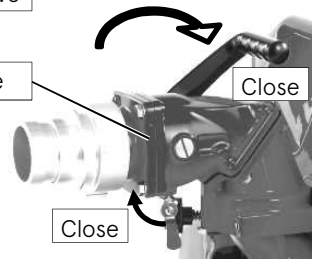

### Closed Circulating Water Cooling System

In this system, engine cooling water is taken from the suction water, and pressurized by the pump. The water goes through the engine and the muffler, and returns to the water intake of the pump.

---

## 6. PREPARATION FOR OPERATION

---

### Overheat protection sensor

When you turn on the overheat sensor switch, this device shuts down the engine automatically when the engine has excessively overheated caused by lack of cooling water. Usually turn on the overheat sensor switch.

### Overheat warning lamp

If the temperature of the cooling water reaches approximately 75°C or more, the engine will be stopped automatically to prevent overheating.

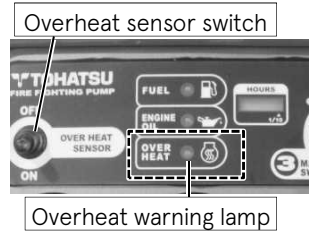

### Warning lights and sensors

Turning the main switch ON, if there is no problem with these checkpoints, the lamp will remain off and the buzzer will not sound.

#### CAUTION

- **After the engine has stopped due to overheating, if you restart the engine immediately, engine may be burnt. Before restarting the engine, eliminate the cause (refer to “Chapter 16 TROUBLESHOOTING”). Also, check that the warning lamps are turned off.**

#### NOTE

<Alert action check (Lamp check) >

- When the main switch is turned ON, the warning lamps and buzzer will be activated for approximately one second. After one second, the warning lamps are all turned off in the condition of power ON, it shows there is no trouble on each function.
- If the warning lamps turn on or blinking, the function in particular does not work properly.

### Battery installation

The battery mounted on the engine can be used immediately after filling cells with electrolyte (1.28 specific gravity at 20°C=68°F). Refer to the INSTRUCTIONS on the battery.





## 7. USE OF OPERATION PANEL

If all the warning lamps are off, each function is working properly.

**\* Countermeasure (Warning lamps turn ON)**

It is necessary to take a countermeasure if the lamp lights up when turning the main switch ON. Then take a countermeasure referring to "Chapter 16 TROUBLESHOOTING".

	Warning indicators			Warning buzzer	Engine operation	Description of faults or notice	Remedy
	 Fuel warning lamp	 Oil warning lamp	 Overheat warning lamp				
Alert check	One time flash	One time flash	One time flash			Normal system test (*1)	
Fuel Level	ON					Fuel level below approx.1/3	A
Oil level		ON		ON		Oil level below approx.1/3	B
Overheat			ON	ON	Stop	Engine stop	C

\*1. Just after turning on the main switch.

---

## 7. USE OF OPERATION PANEL

---

### Remedy

A: Supply fuel.

B: Supply 2 stroke engine oil.

C: Read the TROUBLE SHOOTING and remedy it.

### In the case of overheat

- Check the cause and remedy it.
- Turn off the overheat sensor switch and start the engine. After confirming the lamp is off, return the switch to the "ON" position.

The system does not detect overheat caused by some reasons such as shortage of engine oil or abnormal gas-mixture caused by malfunction of the carburetor.

### DANGER

- **Before removing the electrical equipment, turn the main switch off and remove the battery.**
- **When removing the battery cable from the battery terminal, always disconnect the negative (-) cable first.**
- **When connecting battery cable, connect the positive (+) lead first.**
- **If you connect the negative (-) lead first, hydrogen gas generated by the battery may cause an explosion.**
- **Do not place any metal on the top or around the battery. Doing so may cause a short circuit.**

### NOTE

- If the warning lamp does not light when the lamp have to light (i.e. the fuel level is below one third of the tank), the bulb could be burned out. Then replace the lamp bulb or consult with your dealer.
- When carrying out a periodical inspection and pre-operation checks, check the monitor lamps and also each individual component.
- The system does not detect such overheat as caused by shortage of engine oil or abnormal thin gas-mixture occurred due to carburetor's malfunction.

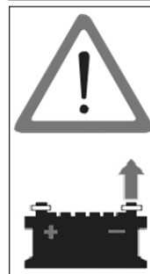



---

## 7. USE OF OPERATION PANEL

---

### Hour meter

- (1) The hour meter starts counting when the main switch is turned "ON" position.
- (2) The hour meter only works during the main switch is "ON" position.
- (3) There is no reset capability.
- (4) The hour meter covers a time 0.1 hour to 9,999 hour, and it rolls over to 0 when it reaches maximum range.

<b>NOTE</b>
-------------

- In case of engine stop due to overheat or fuel shortage, the meter will continue counting while the main switch is ON

---

## 8. STARTING THE ENGINE

---

### Installation of pump

#### WARNING

- Since the temperature around the engine become high because of the muffler and exhaust gas, install the pump on level ground at least three meters away from inflammable materials including dry grass and wood.
- Exhaust gas, which contains carbon monoxide, is a deadly poisonous gas with no color and no smell. Do not operate engine in a closed space or in insufficient ventilation place, such as indoor, in the vehicle, warehouse, tunnel, well, in the hold of a ship.
- Do not start engine with discharge valve opened.
- Do not pump and discharge liquids other than water (e.g. flammable liquids or chemicals).
- This pump is only designed to pump water.
- Do not discharge water to water-prohibiting substance.
- Do not insert your hand and/or finger into the suction port to avoid serious injury by the rotating part.



#### CAUTION

- Do not run the pump without suction side strainer. If gravels go into the pump, then the pump will be damaged and the performance would be significantly reduced.

1. Place the pump near water source on a flat area.
2. Connect suction hose and delivery hose to the pump securely. Put end of suction hose in water source. The suction hose must have a strainer and a basket at the tip of the suction hose.
3. Recommended diameter of the nozzles for the pump\*.  
Single outlet use: in between 21.5 ~ 36.0 mm (0.8 ~ 1.4 in)  
Twin outlet use: in between 15.2 ~ 25.0 mm (0.6 ~ 1.0 in)  
\* 3 (m) of suction head.

## 8. STARTING THE ENGINE

### Starting engine



- Wear proper hearing protection during operation.

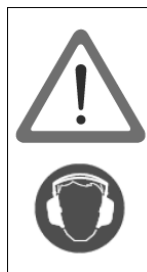

- While engine is running, do not touch the high voltage Ignition wire attached to spark plug. This wire carries very high voltage which will cause injury and bodily harm.



- Do not operate pump on dry grass. The exhaust system gets very hot and will ignite dry grass. Cleaning out dry grass in the area if necessary.



1. Turn the fuel valve to open position, this will allow fuel to flow to the carburetor.

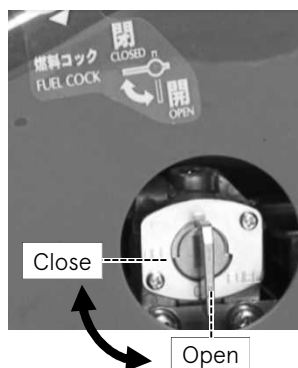

## 8. STARTING THE ENGINE

2. Turn the throttle dial to the “START・SUCTION” position.

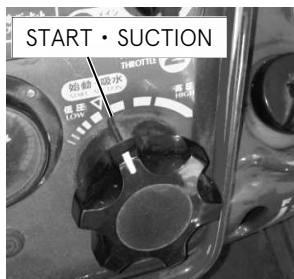

3. Turn the main switch to the “START” position.

Release the main switch immediately after the engine starts.

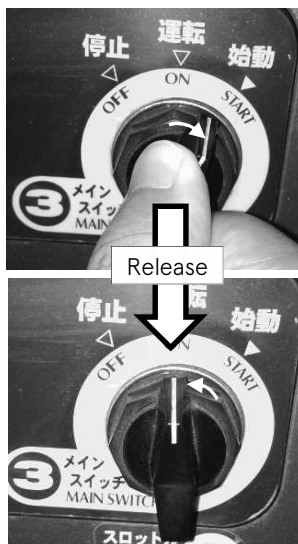

### NOTE

1. Extended operation of the starter motor will run the battery drain.  
Operate the starter motor for maximum 3 seconds.  
If the engine does not start, wait for 5 seconds before operating the starter motor again.
2. Do not operate the starter motor after engine started.
3. If the starter motor does not work, check that the battery terminals are tightly connected and the battery is fully charged.

\* If electric starter does not work to start, use the recoil starter.(Manual operation)

## 8. STARTING THE ENGINE

### Starting engine by manual operation (Using a recoil starter)

If electric starter does not work, use a manual starter.

When you use the manual starter, operate the engine as shown below.



1. Turn the fuel valve to open position, this will allow fuel to flow to the carburetor.

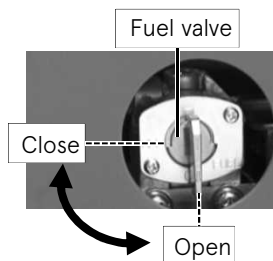

4. Turn the throttle dial to the “START • SUCTION” position.

5. Turn the main switch to the “ON” position.

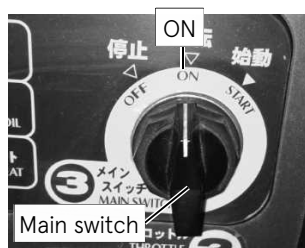

6. Engage the manual starter ratchet by pulling the starter rope slowly. And then pull the starter handle quickly with great force from the position in which feeling harder resistance.

\*Holding the fire pump in place with your foot.

7. After engine starts, return the starter handle to the original position slowly. Do not let the starter handle go off, this can cause damage to the recoil of the starter.

#### WARNING

- Do not run the engine with manual starter cover opened. Doing so will result in serious injury.

#### CAUTION

- Do not pull the manual starter handle when the pump is running. Otherwise, the manual starter may be damaged.



---

## 8. STARTING THE ENGINE

---

### Dry operation

This portable pump has an outside water cooling system, limit the duration of dry operation so that it is within the following time periods.

Performing dry operation longer than the specified time period may cause damage to the engine or pump.

Idle position: within 2 minutes

Throttle dial at "START" position: Within 30 seconds

### Closed discharge valve operation after priming water

When the pump is operated with the discharge valve closed, the cooling water temperature becomes high.

**WARNING**

- **Do not run the engine with opened recoil starter to avoid serious injury.**

 **CAUTION**

- **Continuing the closed discharge valve operation after priming water, the pump will be overheated.**

## 9. PRIME AND DISCHARGE

### WARNING

- **While the engine is running, do not touch the rotating parts of the pulley or belt. This can cause personal injuries.**

### NOTE

- If the pump cannot suck water during the operation of the vacuum pump for 30 seconds, or cannot keep the water in the water path of the pump during the water discharge operation, check the following:
  - Is the tip of the suction pump hose completely under the water surface?
  - Is air sucked through the joint of the suction hose?
  - Is the suction hose damaged?
  - Does the vacuum performance of the priming pump reduced significantly?
  - Does the pump case leak vacuum?
  - Does a vacuum leak occur when the pump is connected with the suction hose which the opening side is capped?



Refer to "Chapter 16 TROUBLESHOOTING".

1. After starting the engine, pull down the priming lever up to put tension on the V- belt leading vacuum pump operation for suction.
2. Check that the pumped water is discharged continuously from the priming outlet of the vacuum pump. Make sure the pressure gauge shows positive side.
3. Return the priming lever to the original position.

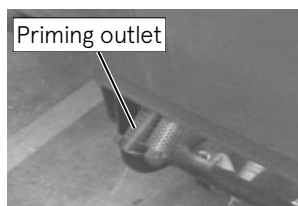
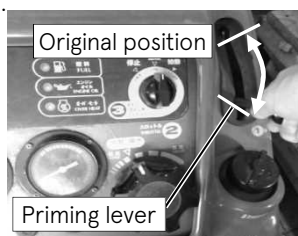

---

## 9. PRIME AND DISCHARGE

---

**NOTE**

- Limit the vacuum pump operating time within 30 seconds. If the pump cannot suction water within 30 seconds, it may have another problem. Refer to “Chapter 16 TROUBLESHOOTING” to rectify the problem.
- When priming water from a water source that is considerably lower location than the pump, suction may fail to bring water up to pump.
- Do not operate the engine more than 2 minutes without pumping water.
- If the elevation of suction hose does not follow a downward slope from the pump to the water source, an air trap occurs and there could have insufficient discharge volume. In such case, immediately re-prime the pump.
- When the air pocket stays trapped inside of suction hose, open the discharge valve, and operate vacuum pump 3-5 seconds intervals until there have smooth discharge water stream.

### 4. Open the discharge valve.

#### Ball cock discharge valve

Turn the discharge port lever towards the discharge port adapter (hose) at slow speed.

The discharge port can be turned approximately 90 degrees.

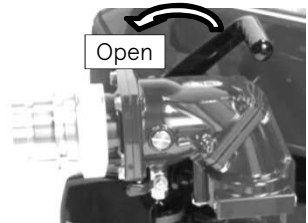

#### Screw down discharge valve

Turn the discharge valve handle to the left (counter clockwise).

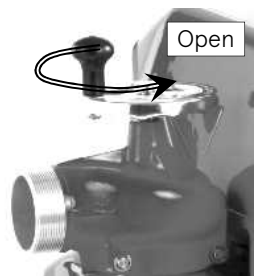



## 9. PRIME AND DISCHARGE

### ⚠ CAUTION

- Before opening water discharge port or valve of the pump, make sure to warn the person holding the nozzle or the branch pipe to check the nozzle is opened and ready to discharge water.
- During operation, check the suction and discharge hoses. They must be free of kinks, pinches, etc., possibly caused from emergency vehicles rolling over hose.



### NOTE

- To avoid the air left in the hose, the pump should be located above the suction hose. If some air left in the hose, the pump may not be able to discharge the water by the accumulated air in the hose when you open the discharge valve. In this case, open the discharge valve and operate the vacuum pump for 3 to 5 seconds until the water is continuously discharged.

5. Adjust the water pressure (volume) using the throttle dial.



### ⚠ CAUTION

- In the case of using a branch pipe, the person holding the branch pipe must be notified of changes in water discharge pressure caused from engine speed changes or discharge valve setting changes discharged water should not be directed toward people under any circumstances.
- Do not look into the nozzle opening at any time.
- Do not put fingers or hands into the discharge nozzle.

---

## 9. PRIME AND DISCHARGE

---

### Performing relayed water supply (When using water from fire hydrant)

1. Decide the pump pressure in consideration of the water discharge pressure (nozzle pressure), hose pressure loss, and height loss.

$$\text{Pump pressure} = \text{needed pressure} + \text{friction loss} + \text{height loss}$$

2. Foreign materials such as dirt, gravel, iron rust, etc. may have intruded into a fire hydrant. Before connecting a hose, open a fire hydrant to discharge water in order to remove foreign materials.
3. When using water from a fire hydrant, set a mediation metal between the delivery hose and the suction port.
4. Set the discharge valve handle of the pump to the full open position.
5. Gradually open the fire hydrant on-off valve. However, check the water pressure from fire hydrant with suction pressure gauge on the pump and adjust the opening of fire hydrant, if necessary.



- **If the water pressure from fire hydrant is higher than 6 bar, do not continue to open the fire hydrant on-off valve.**
  - **If the water pressure from fire hydrant is higher than the required discharge pressure, it is not necessary to start the pump. If the water pressure from fire hydrant has not reached the required pressure, start the engine.**
6. If the water pressure from fire hydrant is insufficient, start the engine and adjust the pressure to the required level by operating the throttle dial. Stop increasing discharge pressure if the suction pressure gauge shows 0.1MPa (15 psi) or below. If it does, stop increasing the pressure and keep the throttle dial as it is.
  7. To end discharging water, turn the throttle dial to the low pressure firstly, then stop the engine, and close the fire hydrant on-off valve.



- **Be sure not to close the discharge valves of all the pumps and the nozzle until all the pumps stopped and the fire hydrant on-off valve is closed.**
8. Set the discharge valve to the half-open position, and open all the drain valves to drain the remaining water as maintenance after operation.

# 9. PRIME AND DISCHARGE

## Relay pumping operations

- CAUTION** · In the case of relay pumping operations training in a flat place, if the number of extending hose is less than ten, use the safety nozzle (Pumping plate) attached.

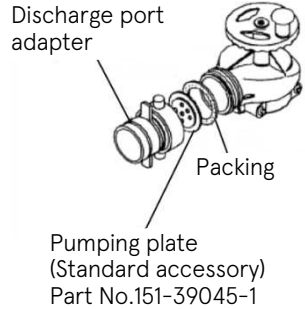

## Description of relay pumping operation

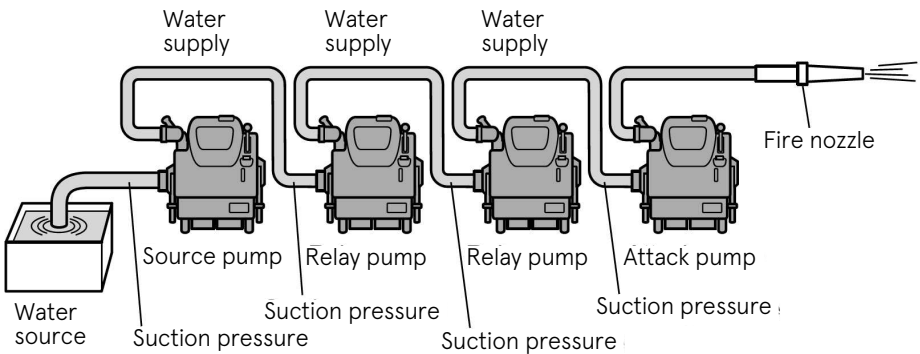
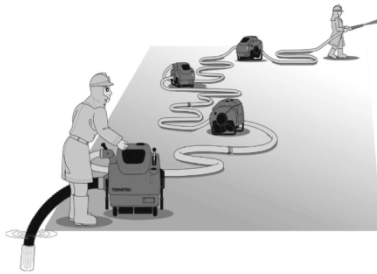

---

## 9. PRIME AND DISCHARGE

---

### Preparation for operation

**WARNING**

- **Do not close the discharge valve of source pump, relay pumps and fire nozzle. If the discharge valves or nozzle are (is) closed, there will be a risk of damage to the pumps and hoses with excessive pressure or water hammer.**

1. Decide how many relay pumps are needed in consideration of distance and height between the water source and the fire ground.
2. Place the pumps according to the decision, and connect the hoses.
3. Make sure that the discharge valves and the fire nozzle are all opened.
4. Decide the discharge pressure of each pump in consideration of needed pressure for next pump (or fire nozzle) and the height loss and friction loss.

$$\text{Pump pressure} = \text{needed pressure} + \text{friction loss} + \text{height loss}$$

### Start the source pump

**WARNING**

- **Once the water supply has started, keep supplying it until finished. If reduce or stop supplying water, overheat or cavitation may occur in the relay pumps.**

1. Start the source pump according to "Chapter 8 STARTING THE ENGINE".
2. Start supplying water according to "Chapter 9 PRIME AND DISCHARGE".

---

## 9. PRIME AND DISCHARGE

---

### Start the Relay pump

1. Make sure that the discharge valve is opened and wait for supplied water.
2. Check that the water was supplied from the source pump. At first, the hose swells due to air pressure. Step on a hose to judge whether the swelling of the hose is due to water or air.
3. If it becomes clear that water was supplied to the pump, read a pressure gauge. Start the engine if the pressure is lower than the required pressure. If the pressure is high enough, no need to start the engine.
4. Adjust the discharge pressure with throttle dial. The suction pressure decreases with opening up the throttle. Always confirm the pressure with the suction pressure gauge.
5. If the suction pressure drops below 0.1 MPa (15 psi), order the operator of the pre-stage pump to increase the water pressure, and adjust the relay pump pressure by the throttle.
6. If suction pressure rises, adjust the throttle again.

### Start the Attack pump

It is the same as the relay pump case.

### Finish the relay pumping operation

1. Do not close the fire nozzle.
2. Stop the attack pump running first.
3. Stop the relay pump running from the pump near the nozzle.
4. Finally, stop the source pump.



**CAUTION**

- **Do not touch the exhaust pipe and the muffler while the engine is running, or for more than 10 minutes after the engine has been stopped.**
- **Confirm the engine temperature is cooled down enough. These parts are very hot and will cause severe burns.**



---

## 10. STOPPING THE ENGINE

---

1. Return the throttle dial to "LOW" position.

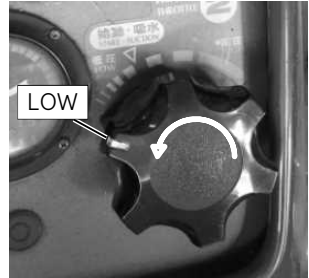

2. Close the discharge valve.

Screw down discharge valve \_\_\_\_\_

Turn the discharge valve handle to the left (Clockwise).

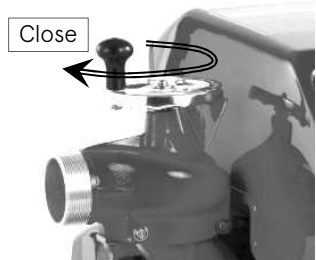

Ball cock discharge valve \_\_\_\_\_

Turn the discharge valve handle to close.

The discharge port can be turned approximately 90 degrees.

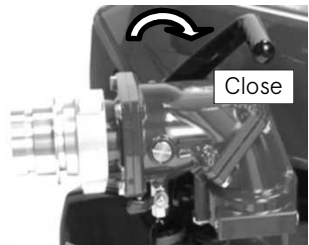

3. Stop the engine

Turn off the main switch.

4. Close the fuel cock.

5. Open all the drain valves to drain water. Refer to "Chapter 11 MAINTENANCE AFTER OPERATION".



---

# 11. MAINTENANCE AFTER OPERATION

---

## Drain Water

1. Open the drain valves and drain all the water from the pump.  
Do not leave water in the pump.
2. Close the drain valves for the next operation.

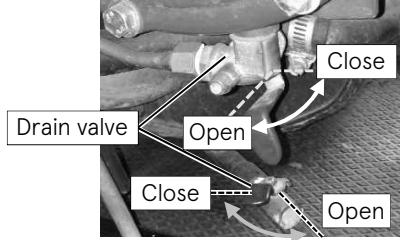

For ball cock discharge valve

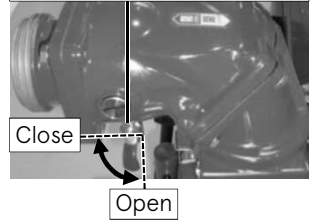

## Check Suction Performance

- After the drainage of all the water from the pump,
1. Install the suction port cap.
  2. Confirm the drain valves are all closed.

**NOTE**

- Prepare a suction port cap that is suitable for the suction coupling.

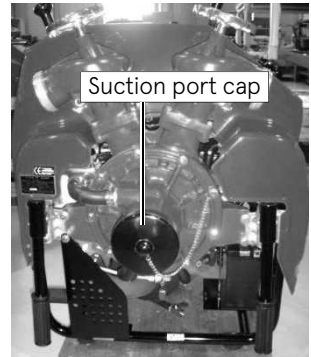

3. Turn the throttle dial to " START " position, start the engine, and pull down the priming lever to produce a vacuum (within 30 seconds).

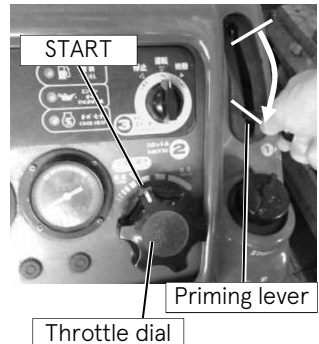

## 11. MAINTENANCE AFTER OPERATION

4. After a vacuum is produced, return the priming lever to the original position immediately, and stop the engine.

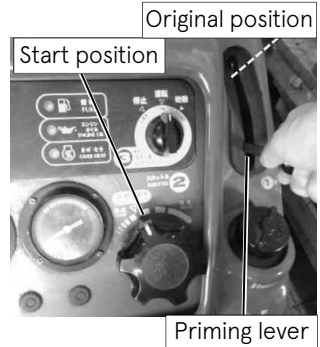

5. Check the vacuum pressure of the pressure gauge for suction is below  $-0.08$  MPa ( $-12$  psi).
6. To check for vacuum leaks, leave it for 30 seconds and confirm that the pointer of the pressure gauge for suction keep the same pressure indicated.
7. Open the drain valve slowly to expose it to the atmosphere, and check that the pointer of the pressure gauge for suction returns to "0".

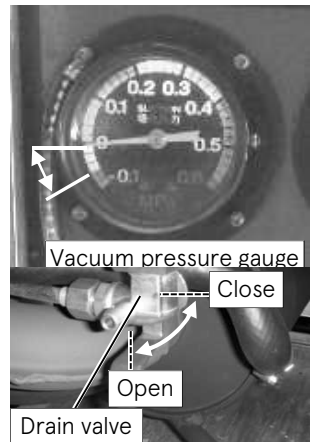

8. Close the drain valve again.

### NOTE

- Before storing the fire pump, flush with fresh water to purge any debris from the pump. (Salt water, muddy water, contaminated water, etc.)
- Rubber gasket, O-ring, seal for the discharge and suction hose fitting wear: a worn rubber seal will cause water leaks, poor vacuum, etc. Frequent inspection of these items is mandatory.



# 11. MAINTENANCE AFTER OPERATION

## Fuel/Oil

### 1. Fuel

- Close the fuel valve and fill fuel until the maximum level of the fuel tank.

The maximum level can be confirm by the Indicator (Red) .

\* Fuel tank capacity : 18L (4.76 gal(US))

- Draining fuel from the carburetor.  
Drain the fuel from the carburetor after using the pump each time.
  - a. After stopping the engine, close the fuel valve.
  - b. Pull the knob of the drain valve. (Fuel will flow out)
  - c. After all the fuel has drained, release the knob. (The drain valve will return to the closed position)
  - d. Fuel from the drain pot could be returned to the fuel tank.

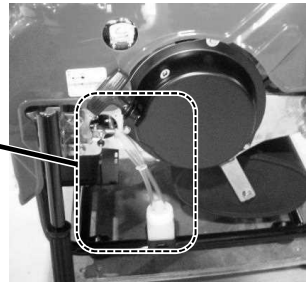
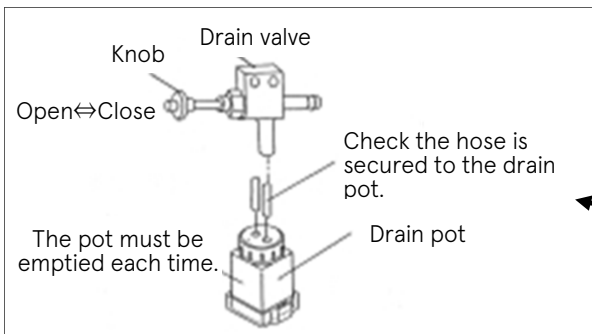
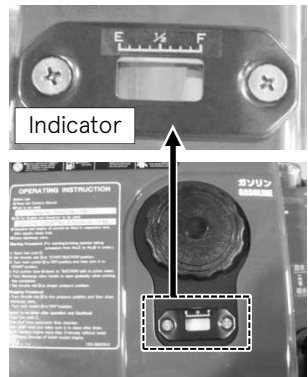

### **CAUTION**

- **Wipe off fuel using a cloth or the other materials if there is fuel out of the fuel tank.**
- **Drained fuel collects into the drain pot. This must be emptied into the fuel tank.**

### **NOTE**

- Make sure the fuel is kept full in the fuel tank.

---

## 11. MAINTENANCE AFTER OPERATION

---

### 2. Engine oil

Fill the oil tank with 2-stroke engine oil up to the "F" level.

Engine oil tank capacity: 1.6L (0.42 gal(US))

**NOTE**

- Use 2-stroke engine oil of ISO FB grade or higher.



### 3. Governor oil

Check the oil level using the dipstick.

**NOTE**

- Use 2-stroke engine oil of ISO FB grade or higher.

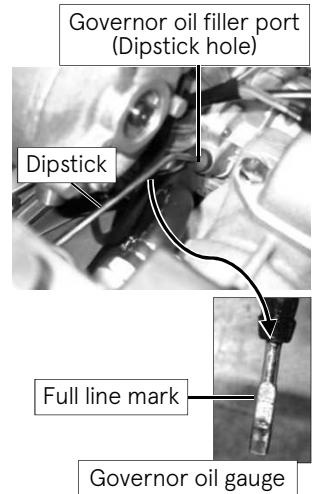

# 11. MAINTENANCE AFTER OPERATION

## Cleaning strainer for prime

Remove the strainer cap and clean the strainer with fresh water. If the strainer is dirty with dust, etc., vacuum performance efficiency will be reduced.

### ⚠ CAUTION

- When installing the strainer, exercise care so that the O-ring does not get caught in, and tighten the ring nut securely. If the ring nut is not tightened completely, the vacuum leak may occur.

### NOTE

- When assembling or disassembling the strainer assembly, tighten or loosen the ring nut while holding and pushing the strainer cap.
- When installing a strainer, pay attention to the protrusion of the O-ring and install it correctly. Otherwise, a vacuum leak may occur.
- When installing a strainer, tighten the ring nut while pressing the cup with your palm.

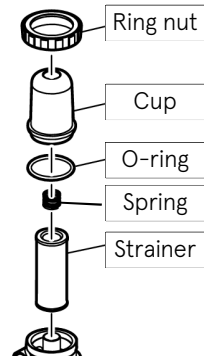
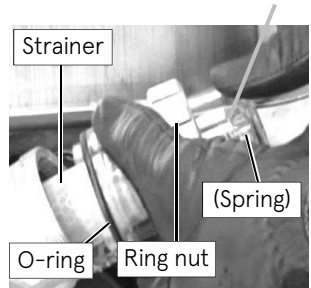
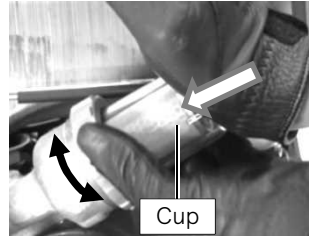

---

## 11. MAINTENANCE AFTER OPERATION

---

### Charging battery

<Battery>

**WARNING**

- Read the safety instructions carefully and/or warnings before using or charging the batteries.
- Hydrogen gases from the battery are explosive. Keep battery away from flame and sparks.
- Charge the battery in well ventilated area. Do not charge battery in unventilated area.
- Connecting battery cables, connect positive (+) lead first.
- Disconnecting battery cables, disconnect negative (-) lead first.

**NOTE**

- Keep surfaces of the battery clean.

<Battery charger>

**WARNING**

- The battery capacity must be 12V-16 Ah/5h or 12V-18Ah/10h.
- Do not connect a cigarette lighter to the battery charger socket, doing so may melt or burn out the socket due to overheating.
- Hydrogen gas inside the battery may explode if something sparks.
- Keep the battery away from flame and sparks.
- Charge the battery in well ventilated area.

 **CAUTION**

- Use an automatic battery charger.
- Use a battery charger that has an overcharge prevention function.
- Read the instruction manual of the battery charger before charging a battery.
- Automatic charger should be kept in a dry and well-ventilated place.

---

## 11. MAINTENANCE AFTER OPERATION

---

1. Be sure to charge the battery after each operation.

Battery charger plug socket location



2. Turn off the main switch.
3. Confirm that there is no dirt, no slack, no backlash of the terminal.
4. Plug the charging plug to the battery charger plug socket.
5. Insert the input plug to the alternative current source.
6. Confirm the battery charging status referring the battery instruction manual.
7. Disconnect the battery charger plug from the socket when using or moving the pump.



Battery charge plug and socket

### NOTE

- If the main switch is on, the battery cannot be charged.
- Pull out the battery charger plug from the socket when using or moving the pump.

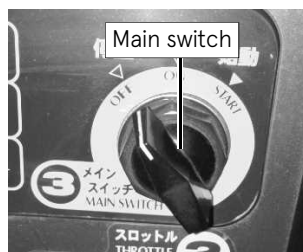

---

## 12. MAINTENANCE IN COLD CONDITION

---

### Infuse anti-freezing fluid



- If the temperature around the pump could be subzero, the inside of the pump can be frozen up. In this case, the pump or the vacuum pump may not be operated, and also the pump unit including engine and muffler, may be damaged or broken.
- In order to prevent internal corrosion and freeze damage by the water in the pump, drain all the water from the pump unit.
- After draining the water, put antifreeze fluid into the pump and vacuum pump.

<For pump unit>

1. Open the drain valves. Drain all the water from the pump.

In the case of the ball cock discharge valve, the valve has a drain valve at the bottom. Drain water also from here.

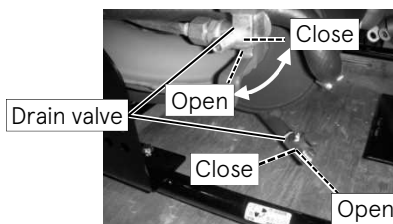

2. Close all drain valves.

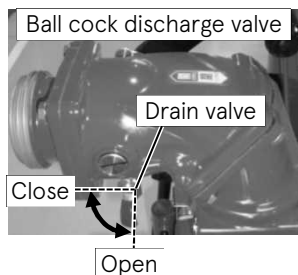

3. Set a suction cap that is suitable for the suction coupling.

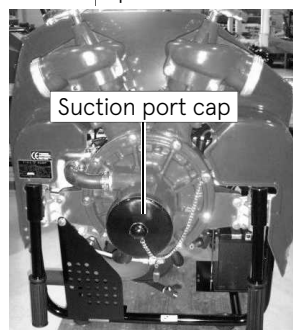

## 12. MAINTENANCE IN COLD CONDITION

- Attach the plastic tube to the pump drain valve and open the valve at the pump case.
- Insert the plastic tube in the container filled with antifreeze fluid.  
(180 mL/0.048 gal(US) – 200 mL/0.053 gal(US)).

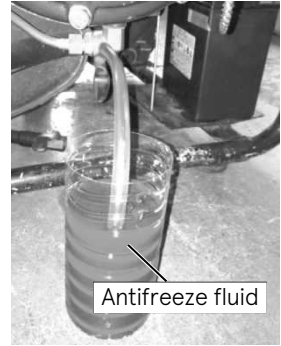

- Turn the throttle dial at “START • SUCTION” position.  
Turn the main switch ON.

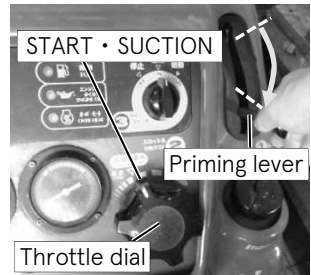

- Turn the main switch to start. Release the main switch immediately after the engine starts.



- After starting the engine, suck antifreeze fluid by operating the priming lever

### NOTE

- Even if antifreeze fluid disappears, continue pulling the priming lever for approximately 30 seconds. By this operation, antifreeze fluid goes every part in the pump water line.

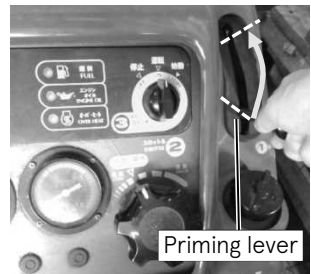

Return the priming lever to the original position.

## 12. MAINTENANCE IN COLD CONDITION

9. Return the throttle dial to "LOW" position.

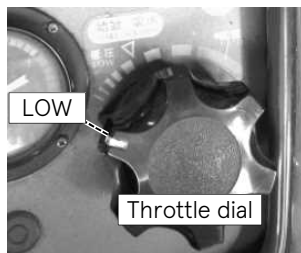

10. Turn off the main switch.

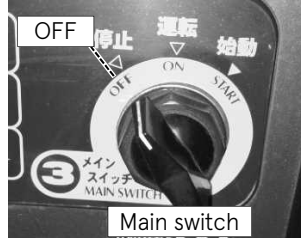

11. Close the fuel valve (cock).

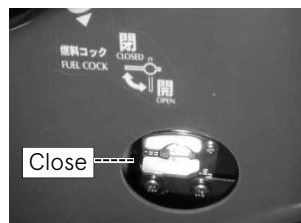

<For discharge valve>

Fill antifreeze fluid into the seal area of the discharge valve.

\* To use a long nozzle containing is helpful when pouring antifreeze fluid.

Screw down discharge valve \_\_\_\_\_

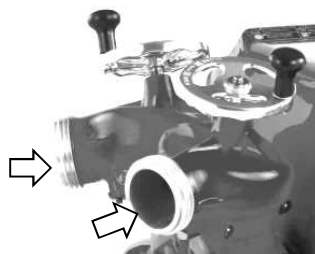

Ball cock discharge valve \_\_\_\_\_

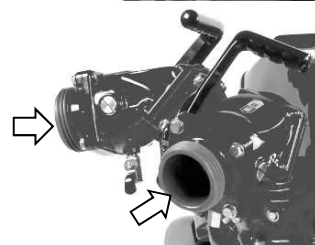



---

## 12. MAINTENANCE IN COLD CONDITION

---

<For primer>

1. Remove the strainer and strainer cup.
2. Inject antifreeze (undiluted 50 mL / 0.01gal) into the strainer guide.
3. After injection, assemble the strainer.



**NOTE**

- When assembling or disassembling the strainer assembly, tighten or loosen the ring nut while holding and pushing the strainer cap.
- When installing a strainer, pay attention to the protrusion of the O-ring and install it correctly. Otherwise, a vacuum leak may occur.

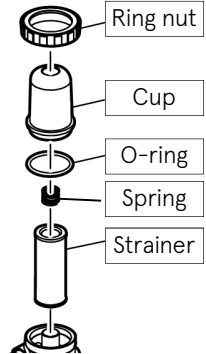

---

## 12. MAINTENANCE IN COLD CONDITION

---

### Battery

As the temperature decreases, battery performance decreases. Also, if the specific gravity is low, the battery may freeze.

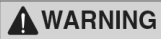

- **Hydrogen gas from a battery is explosive. Keep the battery away from flames and sparks.**
- **Hydrogen gases emitted from the battery will also cause severe burn to skin and damage to clothing.**
- **Charge a battery in a well-ventilated place. Do not charge it in unventilated area.**

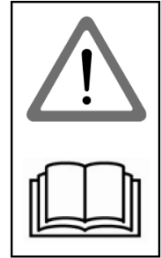

- **Read the instructions attached to the battery carefully before use.**
- **When charging batteries, be sure to use an automatic battery charger.**
- **Use an automatic battery charger that matches the battery specifications. Use of a mismatched automatic battery charger may cause the battery to explode.**
- **Keep the battery surface clean.**
- **Battery life is normally 2~3 years even if a battery is used properly. Replace with new battery every 2~3 years checking the deterioration of the charging performance.**
- **When connecting battery cables, positive (+) lead shall be connected first. (When disconnecting battery, remove the negative (-) lead first.)**
- **Battery electrolyte is very caustic acid, which will cause severe burns to skin and damage to clothing.**



### Battery charger

Read the instruction manual of the battery charger.  
The instruction manual is packed with the charger.



- **Set the battery charger on a suitable non-inflammable stand or fix on wall, not directly set on the ground.**



---

## 13. USE OF ACCESSORY

---

### Pumping plate



- When you use the fire pump without a nozzle as a water lifting pump, such as pumping water out of a cellar, put the pumping plate\* with holes in between the discharge port adapter screw and the bracket packing in order to prevent overheating of the engine and also to prevent cavitation in the pump which may cause damages to the pump.

\* Pumping plate is the standard accessory: Part No. 151-39045-1

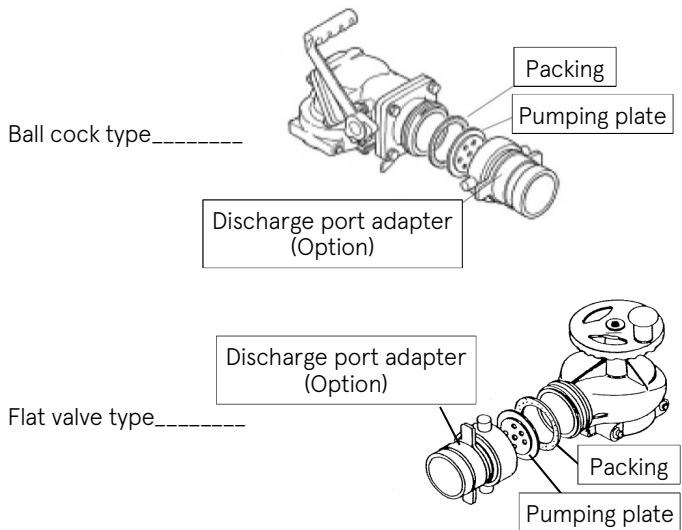

When using the pump without a nozzle, put the pumping plate between the discharge port adaptor and the packing as shown in the figures above.

### NOTE

- Put the pumping plate as the figure shown above, so that pressure for cooling water in the pump is maintained at certain level. Then you can use the pump without a discharge nozzle.

---

## 14. PERIODICAL INSPECTION

---

Pay serious attention to keep the pump in a good condition.

1. To store a fire pump properly:
  - Place it in a level place.
  - Keep it in a dry area. High humidity may cause corrosion in some parts of the pump.
2. Keep the fire pump free of dust.
3. Keep the fuel in the fuel tank full.
4. Fill the governor case with 2-stroke oil to proper level.
5. Run and operate the pump at least once a month.
6. Check the battery condition once a month. Add distilled water if the battery liquid level is lower than the specific level. And charge the battery.  
If the battery is maintenance free battery, do not add any water. Just charge the battery.
7. Drain the fuel completely from the carburetor. (After using the pump each time.)
8. Replace the spark plug\* when it is dirty or worn.
  - \* No.: NGK BPR7HS-10 ... Gap 0.9~1.0 mm (0.04 in)
9. Replace the V-belt of the vacuum pump if the V-belt is cracked or worn.
10. Close the suction port with the cap to avoid a foreign material entering to the pump.

Inspection intervals should be determined according to the number of hours or number of month, whichever comes first.

## 14. PERIODICAL INSPECTION

**Perform periodical inspections and maintenance according to the following procedures.**

Description		Inspection intervals				Inspection items	Measure
		After each operation	0.5 years or 50hr	1 years or 100hr	3 years or 300hr		
Fuel System	Fuel*2 (Tank)		●			Impurities (ie. Water and/or waste)	Clean*1
		●				Level	Refuel
			●			Preservation period 6 month or more	Replace*1
			●			Degradation (ie. Stink or color)	Replace*1
	Strainer		●			Impurities (of water and/or waste has accumulated)	Clean*1
	Fuel hose		●			Curling, crack, leakage, connection	Replace*1
	Carburetor	●				Remaining fuel in carburetor	Clean or replace*1
Ignition	Spark plug		●			Fouling, wear, gap	Clean or replace
Engine	Cranking				●	Locked or not, poor compression pressure	Replace parts if necessary *1
	Engine oil	●				Oil level	Refill the same oil
	Governor oil		●			Oil level with oil dipstick	Refill
Starting system	Starter rope		●			Wear, damage	Replace*1

## 14. PERIODICAL INSPECTION

Description		Inspection intervals				Inspection items	Measure
		After each operation	0.5 years or 50hr	1 years or 100hr	3 years or 300hr		
Starting system	Battery (Sealed type)	●				Voltage measure	Charge
					●	Period of use	Replace *1 *3
Priming system	V-Belt			●		Wear, crack, belt, tension	Replace*1
	Strainer	●				Clogging or broken mesh	Clean or replace*1
	Primer (Vacuum pump)	●				Locked or not, Check performance (-0.08MPa / -12 psi)	Replace parts if necessary *1
		●				Air leak check	Check pump unit if necessary
Pump unit	Closed valves discharge operation after priming water		●			Check performance (1.0MPa / 145 psi)	Replace parts if necessary *1
Discharge	valve		●		Vacuum leakage		
All parts					●		

- \*1. Ask our customer service staff to replace the parts.
- \*2. When the preservation period is 6 months or more, then replace all the fuel. And check the fuel line including fuel cock regarding with clogging.
- \*3  **WARNING** • **Batteries that have been used for more than three years may explode if charged.**

Inspection interval which has been reached earlier in the running time and the periodic inspection period should be the Inspection timing.

---

## 15. SERVICE AND MAINTENANCE

---

### General

Servicing and maintenance of this fire pump must only be carried out by personnel who have professional related knowledge and who are familiar with this fire pump and regulations regarding safety and accident prevention.

### Before starting maintenance work:

- Stop the engine.
- Disconnect the negative terminal of the battery.
- Place the pump on a level location.



### Safety devices

-  **CAUTION** • **After safety or protective devices have been disassembled as part of servicing and maintenance work, immediately install them back to their original locations, making sure that they run normally without problems.**

### Genuine parts

When replacing parts as part of servicing and maintenance of this fire pump, use only Tohatsu genuine parts.

If genuine Tohatsu parts and accessories are not used it may adversely affect the function and safety of the fire pump.

Therefore, for safety reason, use only Tohatsu genuine parts.

Tohatsu bears no responsibility for any personal injuries or equipment damage that may result from use of parts or accessories obtained from outside sources.

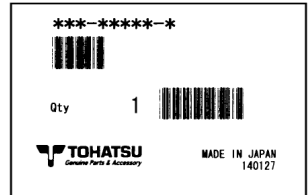

### Environmental protection measures

Dispose of oil, fuel, batteries, etc. according to relevant environmental laws in the region.

Do not dump to nature or sewerage.



### Waste

When discarding parts, go waste in accordance with environmental laws in the region procedure.



---

## 15. SERVICE AND MAINTENANCE

---

### Cowl removal and installation

#### Cowl removal

##### Front

- Unlock knobs (wing screws) at two places. Turn the knobs to left one quarter turn.

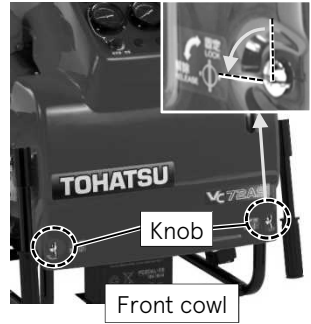

- Remove the cowl slowly, with care given to the area which would be contacted with the vacuum pump tension handle.



##### Rear

- Remove the cowl pins from the hooks.

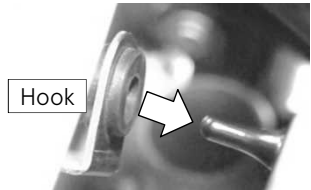

- Detach the spark plug cap at two locations.



- Pull and turn the cowl at around the supporting pins.

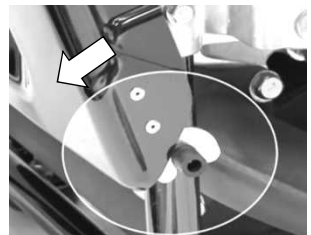



---

## 15. SERVICE AND MAINTENANCE

---

- Pass the spark plug caps through the holes for the leads.
- Remove the cowl from the pins.

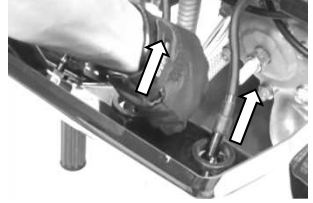

- Remove the cowl

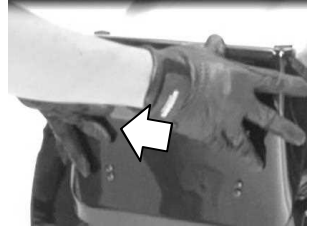

**NOTE**

- Remove the front cowl first, and the rear cowl second.

### Cowl installation

Assembly order is in reverse order of the opening.

Rear

- Put the cowl as shown in the picture.
- Pass the spark plugs through the holes for the leads.

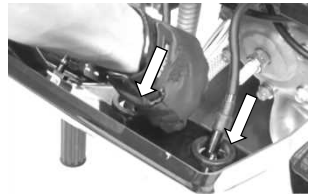

- Set the cowl with two hooks shown in the picture.

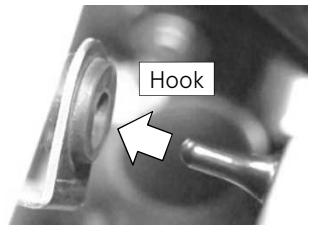

The hooks are located in 2 places. The hooks must be aligned to the socket of the grommet before insert firmly.



---

## 15. SERVICE AND MAINTENANCE

---

### Front

- Set the cowl from upper side as shown in the picture.

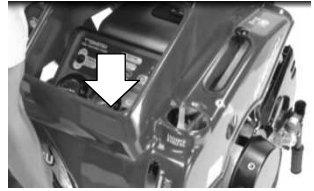

- The hooks are located in 2 places. The hooks must be aligned to the sockets of the grommet before insert.



- Lock the knobs (wing screws) at two locations. Turn the knobs to right one quarter turn.



**NOTE**

- Assemble the rear cowl first, and the front cowl second.



---

## 15. SERVICE AND MAINTENANCE

---

### Vacuum pump strainer

#### Maintenance

**NOTE**

- Incorrect installation of the strainer may cause a vacuum leak. Be sure to install the strainer correctly.

Refer to “Chapter 11 MAINTENANCE AFTER OPERATION”

Wash the strainer with fresh water after each use.

- Turn the ring nut while holding the strainer cup. Remove strainer cup and the strainer.
- Wash the strainer and the strainer cup.
- After washing, assemble the strainer cup and strainer, tighten with the ring nut.

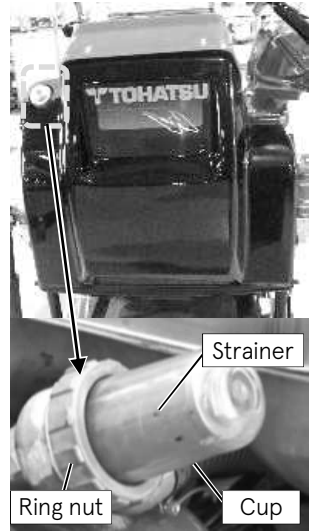

### Engine Oil

Check the oil level after each operation.

- Place the pump in a horizontal location.
- Check the oil level.
- Refill the oil until the “F” level.

**NOTE****2-stroke engine oil**

- We recommend that you use engine oil of ISO FB grade or higher.
- Confirm the filler cap closed tightly each time, whenever you checked the oil level.

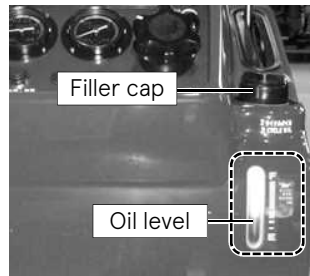

---

## 15. SERVICE AND MAINTENANCE

---

### Governor oil

Check the governor oil level

Check the governor oil level every three months or every 50 hours operating time.

- Place the pump in a horizontal location.
- Pull out the oil dipstick, wipe it with a cloth.
- Insert the oil dipstick completely.
- Pull out the oil dipstick again, and check the oil level.

If the oil level is under the lower line, add 2-stroke engine oil from the oil gauge port up to the full line mark.

Refer to “Chapter 6 PREPARATION FOR OPERATION”

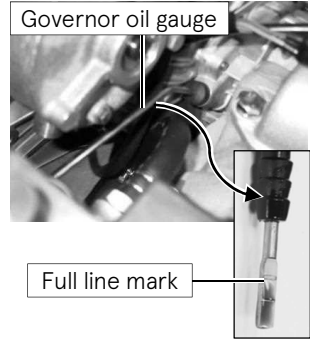

### Vacuum pump V-belt

Check the V-belt.

Check the V-belt every year or every 100 hours operating time.

V-belt size: A-29

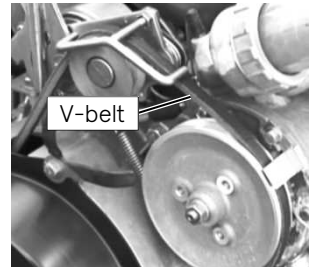

---

## 15. SERVICE AND MAINTENANCE

---

### Spark plug

1. Remove the plug cap, and remove the spark plug.

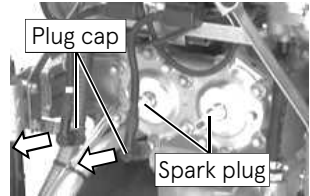

2. Use a wire brush or spark plug cleaner to clean the electrode of the spark plug.
3. Check the spark plug for excessive carbon deposits, electrode erosion and check the washer for damage.
4. Measure the spark plug gap. If the gap is out of specification, replace the spark plug with the specified spark plug.

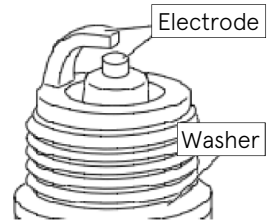

If necessary, adjust the gap to specification.

- Spark plug gap : 0.9-1.0 mm (0.04 in)
- Usage limit : 1.2 mm (0.05 in)
- Spark plug : NGK BPR7HS-10

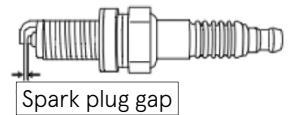

5. After assembling the spark plug, as far as by hand (a), using a plug wrench further tightening, tighten to the specified torque (b).
- Tightening torque : 27 Nm

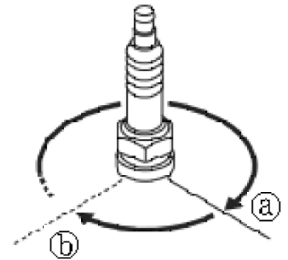

## 15. SERVICE AND MAINTENANCE

### Battery

#### General safety information

Follow the safety instructions on the battery.  
When charging batteries, a highly explosive oxyhydrogen gas mixture is generated.  
Do not charge the battery in a poorly ventilated place.  
Do not smoke near the battery.



**⚠ DANGER** Avoid the injury due to caustic substances of battery.

- Always wear protective clothing.
- Always wear protective gloves.
- Always wear protective glasses.
- Do not tip the battery, acid would come out through the air vents.



#### Disposal

Disused batteries should be disposed of according to local laws or regulations.

After each operation of the battery, check the voltage.  
Replace the battery if necessary.

- Disconnect the negative terminal of the battery cable first, disconnect the positive terminal next.

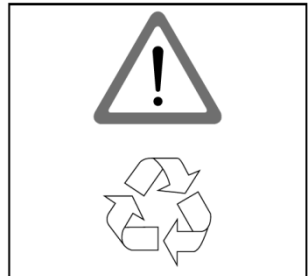

**⚠ CAUTION** • There is a risk of injury. When handling the battery, be sure to wear safety glasses and protective gloves



---

## 15. SERVICE AND MAINTENANCE

---

### Electric equipment

Only expert electricians or trained staff members should handle electrical equipment.

Be sure to disconnect battery cables before handling electrical equipment.

Disconnect the negative terminal first, disconnect the positive terminal next.

When connecting battery cables, connect the positive terminal first, connect the negative terminal next.

Use the fuse with the same current rating (ampere) as that of the installed fuse. Using a fuse that has excessive high resistance may result in electrical equipment failures.

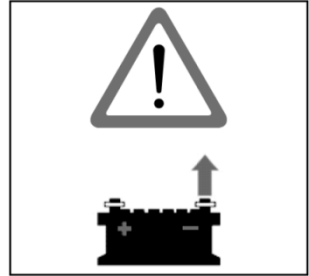

### Fuse

Security fuses are installed in electrical circuits used in electrical equipment.

Before replacing the fuse, isolate the cause of the short circuit, and take the appropriate action.

After the appropriate action has been taken, replace the fuse with a new one.

Prepare the spare fuse at all times for emergency.

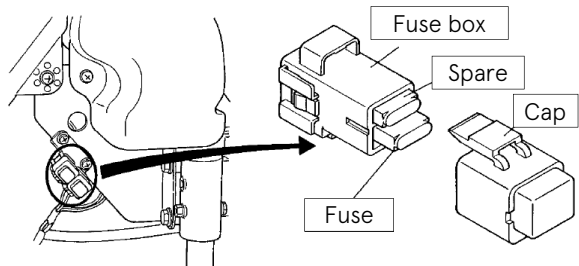
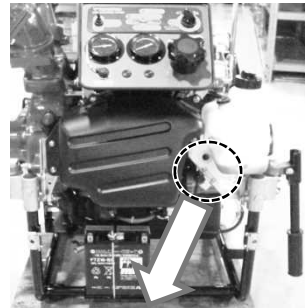

---

## 15. SERVICE AND MAINTENANCE

---

### Suction performance check



#### CAUTION

- Limit continuous operating time of the vacuum pump to 30 seconds or less. Operating the pump for 30 seconds or more continuously may cause the engine to overheat. If the engine overheats, wait until it cools down.

1. Cap the suction port, turn the throttle dial to "START • SUCTION" position, and start the engine.

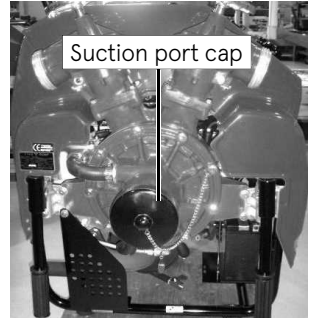

2. Pull down the priming lever to run the vacuum pump, and check that the pressure gauge for suction reads approximately  $-0.08\text{MPa}$  ( $-12\text{psi}$ ).

Return the priming lever to the original position.

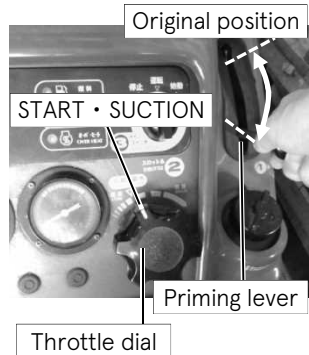

### Vacuum leak check

After completing the vacuum performance check, monitor the pressure gauge for suction for approximately 30 seconds to check for vacuum leaks.

If a vacuum leak is found, isolate the cause by referring to "Chapter 16 TROUBLESHOOTING". Then take the appropriate action and check the vacuum leak again.



---

## 15. SERVICE AND MAINTENANCE

---

### Water leak check

1. Connect one end of the suction hose to the suction port.

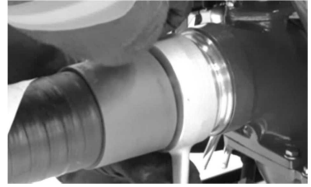

Place the other end of the hose into the water more than 300mm (11.8 in) from the surface, and then close the discharge valve handle.



2. Start the engine, and pull down the priming lever to run the vacuum pump.



3. Operate the throttle dial to raise the pump pressure almost to 1MPa (145psi), and then check for water leaks from each part of the pump and the cooling water piping.



If the leak is found, isolate the cause by referring to “Chapter 16 TROUBLESHOOTING”. Then, take the appropriate action and check the water leak again.

## 16. TROUBLESHOOTING

Typical causes of engine troubles are listed in the following table.

Trouble  Cause		Battery Charging failure	Starter motor does not work	Engine start failure	Engine stumble or stall	Rough idling	Idling is too high	Poor acceleration	Engine over-rev.	Engine overheat	Engine seizing	Action
Fuel and Lubrication	Out of fuel			●	●			●				Refuel.
	Deterioration of fuel			●	●	●		●		●		Replace with new fuel.
	Fuel filter clogging			●	●	●		●		●		Clean out clogging.
	Fuel pipe kink or snap			●	●	●		●		●		Fix routing of pipe.
	Carburetor			●	●	●	●	●	●			Clean or replace with new Carburetor.
	Throttle dial at other than "Start" position			●								Set dial to "Start" position.
	Breather hole clogging				●							Clean out clogging.
	Oil filter clogging						●		●		●	Replace oil filter. (Do not fill it up with the different brand of oil.)

## 16. TROUBLESHOOTING

Trouble		Vacuum pressure defective	Air leaking	Water suction failure	Insufficient water discharge			Floodlight, Gauge lamp, Warning lamp do not work	Action
Cause					Caused by Engine unit	Caused by Play/pipe	Caused by Pump unit		
Fuel and Lubrication	Out of fuel						●	Refuel.	
	Deterioration of fuel						●	Replace with new fuel.	
	Fuel filter clogging						●	Clean out clogging.	
	Fuel pipe kink or snap						●	Fix routing of pipe.	
	Carburetor						●	Clean or replace with new Carburetor.	
	Throttle dial at other than "Start" position							Set dial to "Start" position.	
	Breather hole clogging							Clean out clogging.	
	Oil filter clogging						●	Replace oil filter. (Do not fill it up with the different brand of oil.)	

## 16. TROUBLESHOOTING

Trouble		Cause										Action
Electrical	Spark plug cap comes off			●	●	●		●				Plug in surely.
	Use of unspecified spark plug			●	●	●		●		●	●	Replace with specified spark plug.
	Spark plug fouling (No spark or weak spark)			●	●	●		●				Clean or replace with specified spark plug.
	Battery loose connection, terminal corrosion or expired	●	●									Clean terminal and/or tighten a terminal screw. Replace if necessary
	Battery charger defective	●										Check 5A fuse and/or Battery charger. Replace if necessary

## 16. TROUBLESHOOTING

Trouble		Cause	Vacuum pressure defective	Air leaking	Water suction failure	Insufficient water discharge			Floodlight, Gauge lamp, Warning lamp do not work	Action
						Caused by suction	Caused by Pump unit	Caused by Playpipe		
Electrical	Spark plug cap comes off							●	Plug in surely.	
	Use of unspecified spark plug							●	Replace with specified spark plug.	
	Spark plug fouling (No spark or weak spark)							●	Clean or replace with specified spark plug.	
	Battery loose connection, terminal corrosion or expired							●	Clean terminal and/or tighten a terminal screw. Replace if necessary	
	Battery charger defective								Check 5A fuse and/or Battery charger. Replace if necessary	

## 16. TROUBLESHOOTING

Trouble		Cause										Action
		Battery Charging failure	Starter motor does not work	Engine start failure	Engine stumble or stall	Rough idling	Idling is too high	Poor acceleration	Engine over-rev.	Engine overheat	Engine seizing	
Electrical	15A fuse blown		●									Replace with spare fuse. When the blowout of the fuse happens repeatedly, check a cause. 15A: Battery cable reverse connection, operation panel components
	5A fuse blown	●										
	Starter motor defective		●									Check terminals, cords and screws. Replace parts if necessary.
	Operation panel defective	●	●									Check input of starter solenoid. (Equal to operation panel output.) Replace parts if necessary.

## 16. TROUBLESHOOTING

Trouble		Cause		Vacuum pressure defective	Air leaking	Water suction failure	Insufficient water discharge	Floodlight, Gauge lamp, Warning lamp do not work			Action
								Caused by Engine unit	Caused by Playpipe	Caused by Pump unit	
Electrical	15A fuse blown									●	Replace with spare fuse. When the blowout of the fuse happens repeatedly, check a cause. 15A: Battery cable reverse connection, operation panel components
	5A fuse blown									●	5A: Charging connector and Floodlight connector.
	Starter motor defective										Check terminals, cords and screws. Replace parts if necessary.
	Operation panel defective									●	Check input of starter solenoid. (Equal to operation panel output.) Replace parts if necessary.

## 16. TROUBLESHOOTING

Trouble		Cause										Action
Compression		Battery Charging/failure	Starter motor does not work	Engine start failure	Engine stumble or stall	Rough idling	Idling is too high	Poor acceleration	Engine over-rev.	Engine overheat	Engine seizing	
	Compression	Piston, piston ring or cylinder excessively worn			●	●	●		●			●
Carbon deposition in the combustion chamber						●				●	●	Clean out.
Suction	Suction height too high and/or length too long											Place pump near water source and lower position.
	Suction hose end is not in water.											Put the tip of hose into water more than 30cm deep from surface of water.
	Suction hose coupling loose or gasket defective											Clean out a gasket and tighten securely. Replace a gasket if necessary.
	Suction hose strainer clogged with dead leaf or waste etc.											Clean out
	Suction hose cracking or Lining peeling off											Repair or replace.



## 16. TROUBLESHOOTING

Trouble		Cause		Vacuum pressure defective	Air leaking	Water suction failure	Insufficient water discharge			Floodlight, Gauge lamp, Warning lamp do not work	Action
							Caused by suction	Caused by Pump unit	Caused by Playpipe		
Compression	Piston, piston ring or cylinder excessively worn								●		Correct or replace.
	Carbon deposition in the combustion chamber								●		Clean out.
Suction	Suction height too high and/or length too long					●					Place pump near water source and lower position.
	Suction hose end is not in water	●	●	●	●						Put the tip of hose into water more than 30cm deep from surface of water.
	Suction hose coupling loose or gasket defective	●	●	●	●						Clean out a gasket and tighten securely. Replace a gasket if necessary.
	Suction hose strainer clogged with dead leaf or waste etc.				●	●					Clean out.
	Suction hose cracking or Lining peeling off	●	●	●	●						Repair or replace.

## 16. TROUBLESHOOTING

Trouble		Cause										Action	
Primer	Vacuum pipe loose or cracking												Tighten securely a clump of vacuum pipe or replace.
	Strainer cap loose or "O" ring failure												Tighten securely or replace.
	V-belt damaged or worn												Replace.
	Vacuum pump rotor shaft seizing												Repair or replace.
	Vane, Side plate worn or damaged												Replace.
Water stop valve	Water stop valve contamination												Clean out.
	Water stop valve diaphragm failure												Replace.

## 16. TROUBLESHOOTING

Trouble		Cause		Vacuum pressure defective	Air leaking	Water suction failure	Insufficient water discharge			Floodlight, Gauge lamp, Warning lamp do not work	Action
							Caused by suction	Caused by Pump unit	Caused by Playpipe		
Primer	Vacuum pipe loose or cracking	●		●							Tighten securely a clump of vacuum pipe or replace.
	Strainer cap loose or "O" ring failure	●		●							Tighten securely or replace.
	V belt damaged or worn	●		●							Replace.
	Vacuum pump rotor shaft seizing	●									Repair or replace.
	Vane, Side plate Worn or damaged	●		●							Replace.
Water stop valve	Water stop valve contamination	●	●	●							Clean out.
	Water stop valve diaphragm failure	●	●	●							Replace.

## 16. TROUBLESHOOTING

Trouble		Cause										Action	
		Battery Charging failure	Starter motor does not work	Engine start failure	Engine stumble or stall	Rough idling	Idling is too high	Poor acceleration	Engine over-rev.	Engine overheat	Engine seizing		
Pump	Drain valve is not closed												Close securely.
	Suction port strainer clogged with dead leaf or waste etc.												Clean out.
	Discharge valve imperfect open								●	●			Open securely.
	Gauge pipe connector loose or gasket defective												Tighten securely. Replace gasket if necessary.
	Pump cover bolts loose												Tighten securely.
	Pump cover O-ring degradation												Clean out or replace.
	Impeller or Guide vane caught a stone or damaged												Clean or replace.
	Mechanical seal damaged												

## 16. TROUBLESHOOTING

Trouble		Vacuum pressure defective	Air leaking	Water suction failure	Insufficient water discharge			Floodlight, Gauge lamp, Warning lamp do not work	Action
					Caused by suction	Caused by Pump unit	Caused by Playpipe		
Cause									
Primer	Drain valve is not closed	●	●	●					Close securely.
	Suction port strainer clogged with dead leaf or waste etc.			●	●				Clean out.
	Discharge valve imperfect open					●			Open securely.
	Gauge pipe connector loose or gasket defective	●	●		●				Tighten securely. Replace gasket if necessary.
	Pump cover bolts loose	●	●	●		●			Tighten securely.
	Pump cover O-ring degradation	●	●						Clean out or replace.
	Impeller or Guide vane caught a stone or damaged					●			Clean or replace.
	Mechanical seal damaged	●	●						Replace.

## 16. TROUBLESHOOTING

Trouble		Action										
Cause		Battery Charging failure	Starter motor does not work	Engine start failure	Engine stumble or stall	Rough idling	Idling is too high	Poor acceleration	Engine over-rev.	Engine overheat	Engine seizing	
Nozzle	Too large discharge nozzle diameter									●	●	Change nozzle for suitable size or incorporate safety nozzle.
	Spray nozzle clogged											Clean out.
Governor	Governor adjustment out of specified range						●		●			Readjust it securely.
	Governor link disconnected			●		●	●	●	●			Attach it securely.

## 16. TROUBLESHOOTING

Trouble		Cause		Vacuum pressure defective	Air leaking	Water suction failure	Insufficient water discharge			Floodlight, Gauge lamp, Warning lamp do not work	Action
							Caused by suction	Caused by Pump unit	Caused by Playpipe		
Nozzle	Too large discharge nozzle diameter								●		Change nozzle for suitable size or incorporate safety nozzle.
	Spray nozzle clogged								●		Clean out.
Governor	Governor adjustment out of specified range								●		Readjust it securely.
	Governor link disconnected	●				●			●		Attach it securely.

---

## 17. APPENDIX

---

### Tightening torque specifications.

		M3	M4	M5	M6	M8	M10
Standard Bolt	N·m	0.7	1.6	3	6	13	27
	lb·ft	0.5	1.2	2	4	9	20
	kgf·m	0.07	0.16	0.3	0.6	1.3	2.7
Heat Treated Bolt	N·m				9	24	47
	lb·ft	-	-	-	7	17	34
	kgf·m				0.9	2.4	4.7



---

## 18. TOOL AND STANDARD ACCESSORY

---

Description	Remarks	Quantity
Owner's manual		1
Tool kit bag		1
Tools (Crown spanner 21mm)	General tool	1
Tools (Handle for spanner)	General tool	1
Spark plug	BPR7HS – 10	1
Pumping plate		1
Battery charger	12V	1
Fuse	15A	1
	5A	1
Pipe		1

# 19. WIRING DIAGRAM

Main switch connection table

Color No.	1	2	3	4	5	Description
Position	Black	Black	Red	Green	Black/ White	
OFF	○	○	○	○	○	
OFF		○	○	○	○	↑
Start		○	○	○	○	Automatic reset

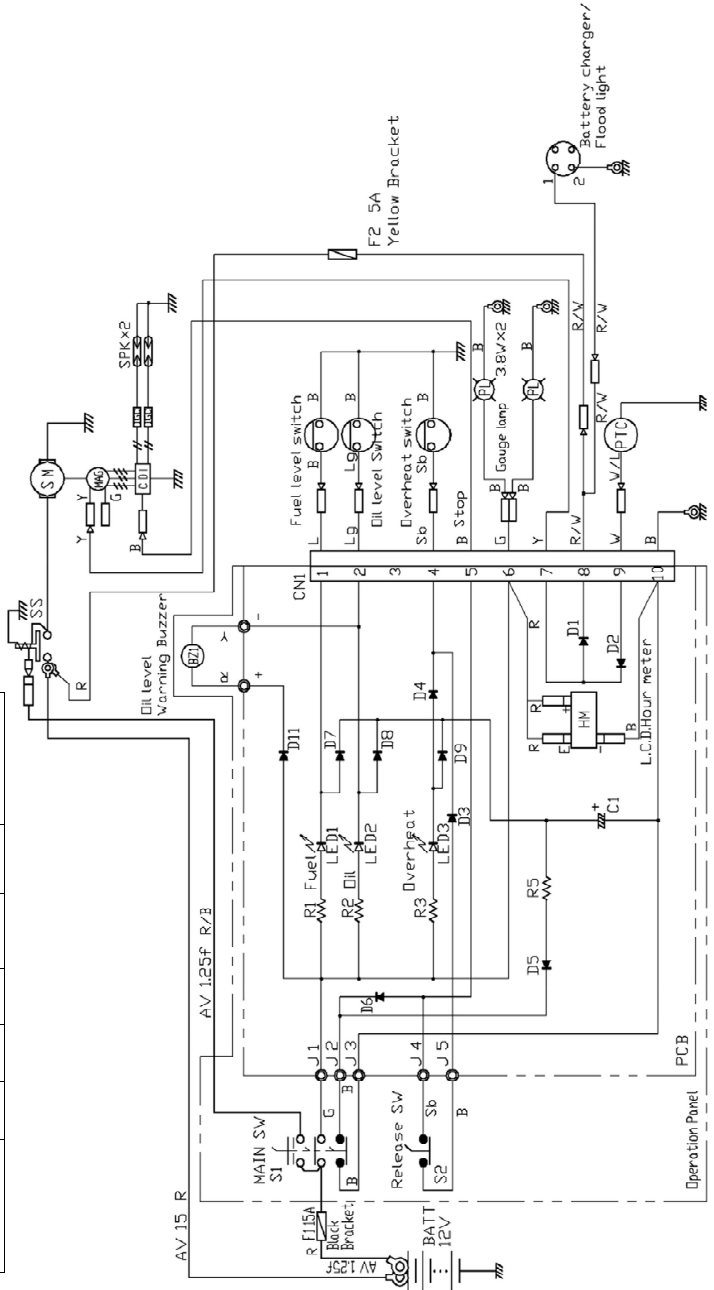

# 19. WIRING DIAGRAM

Main switch connection table

Color No.	1	2	3	4	5	Description
Position	Black	Black	Red	Green	Black/ White	
OFF	○	○				
OFF			○	○		↑
Start			○	○	○	Automatic reset

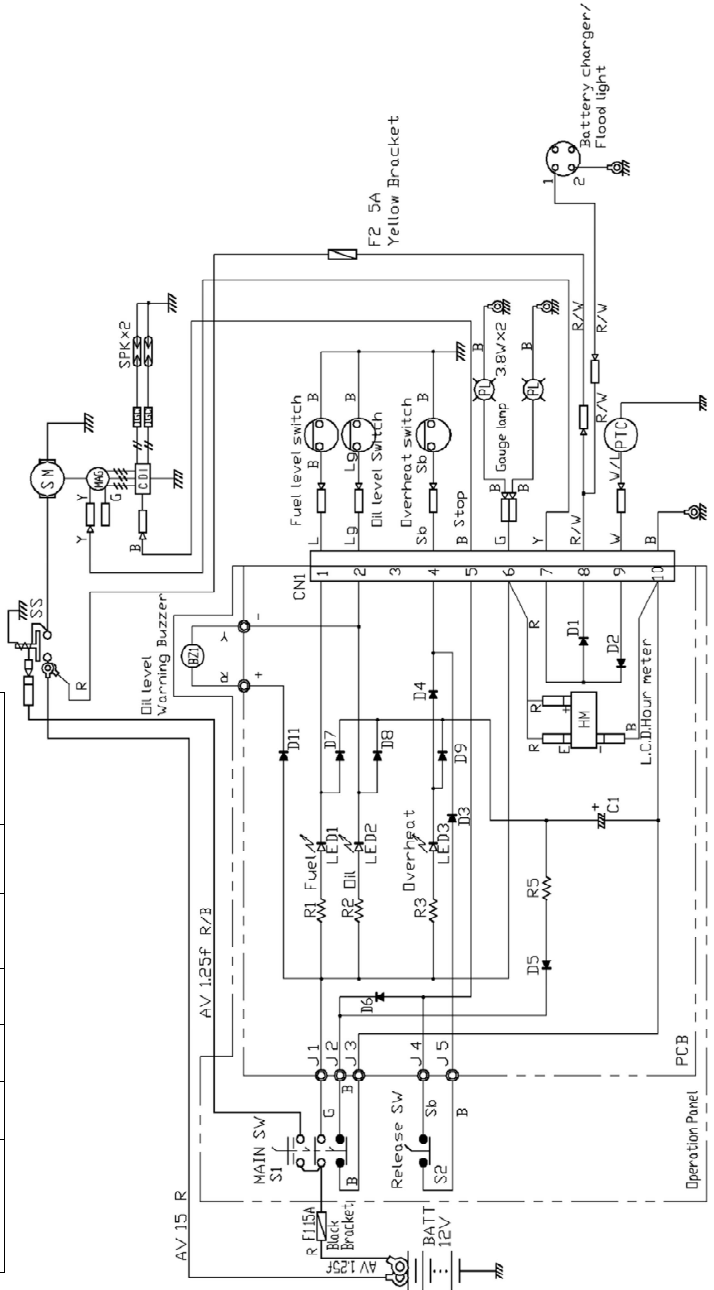

# OWNER'S MANUAL

VC52AS  
VC72AS

PORTABLE  
FIRE PUMP

No.003-12054-3

**TOHATSU CORPORATION**

5-4, Azusawa 3-Chome, Itabashi-Ku  
Tokyo 174-0051, Japan  
Phone: +81-3-3966-3137