

# OWNER'S MANUAL



## VE1500W

### PORTABLE FIRE PUMP

No.003-12078-1

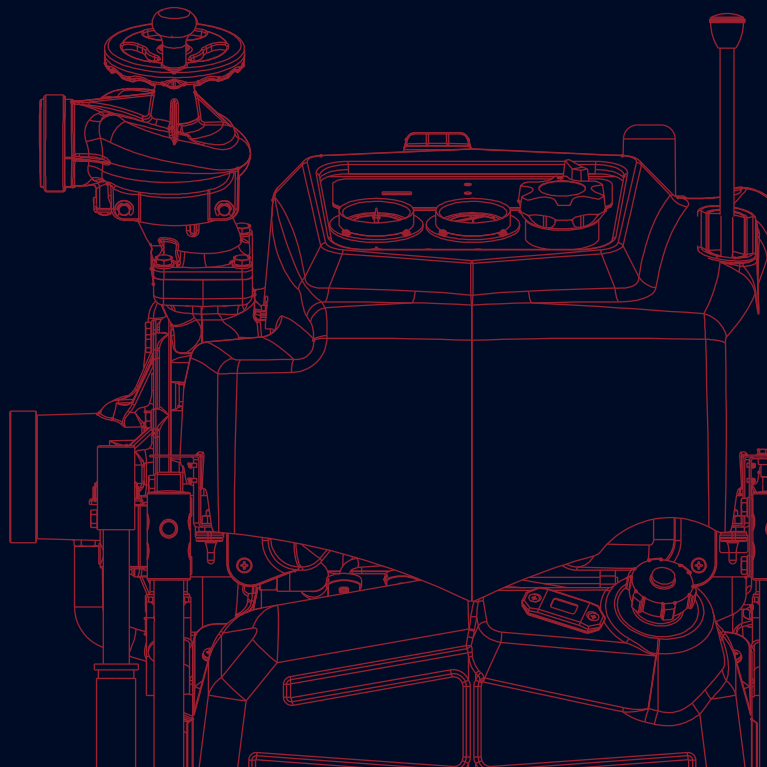

BACKS  
YOU  
UP<sup>™</sup>

Copyright © 2020 Tohatsu Corporation. All rights reserved. No part of this manual may be reproduced or transmitted in any form or by any means without the express written permission of Tohatsu Corporation.

---

## APPLICATIONS OF THIS FIRE PUMP

---

### **USAGE**

TOHATSU fire pump “VE1500W” is manufactured for use in firefighting operations.

This portable fire pump is intended only for firefighting activities in collaboration with general public fire extinguishing equipment.

Using it for other applications is regarded as being used for improper purposes.

The manufacturer of these fire pumps bears no responsibility for any damages that may result from modification of the fire pump without prior permission from the manufacture, improper use of the fire pump, or use of the fire pump for applications other than those stated above.

Note that use the fire pump for applications other than those stated above can result in personal injury or damage to the equipment.

Using the fire pump within the range of intended uses implies that the user should follow the instructions provided by the manufacturer relevant to operation, servicing and maintenance.

## Intended people

All persons who operate, service or maintain this fire pump must read and understand the following items:

- Owner's manual
- Safety-related instructions on the pump and the other parts such as the battery.
- The other owner's manuals, such as battery charger.

The portable pump should be operated by only persons who received training as operators of fire engines along with each country's (region's) regulations.

The range of personal responsibility and supervision must be strictly defined by the user.

If a person does not have adequate professional knowledge required for his/her assignment, he/she must undergo relevant training or receive appropriate instructions from an individual who is actually knowledgeable in operation of this fire pump.

A person who does not have enough knowledge is not permitted to operate the fire pump.

When using the fire pump, conditions under which an explosion may occur are not considered.

### CAUTION

- **Keep this manual in a safe place for future reference.**
- **Operators of this fire pump must always refer to all the relevant manuals in order to avoid errors, personal injuries, and equipment damage when operating the portable fire pump, and to maintain faultless operation.**
- **Arrange owner's manual so that operators can refer to them where they operate the fire pump.**

---

# INTRODUCTION

---

Thank you for purchasing the TOHATSU Fire Pump.

This fire pump has passed a range of quality assurance standards.

## **Owner's manual**

The portable fire pump complies with relevant laws and regulations.

The manual includes a description for operation and maintenance. Before using this fire pump, be sure to read and understand this manual thoroughly.

## **Engine operation**

This manual also includes a description for operation and maintenance of the engine.

<b>NOTE</b>
-------------

- The manual is an important item that goes with your portable fire pump.
- This manual should accompany this fire pump if sold to another person.

---

## MANUFACTURER AND AFTER-SALES SERVICE ADDRESS

---

Before using this fire pump, write down the serial number in the following boxes. It will be useful in the case of asking about servicing, repairs and genuine parts.

Serial Number

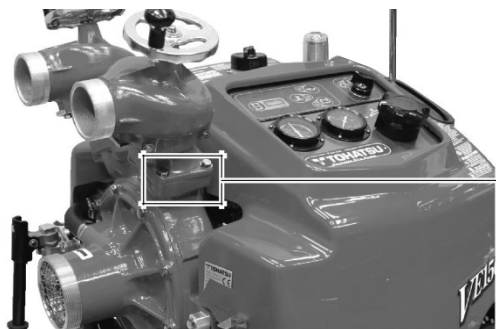

--	--	--	--	--	--

## GENERAL SAFETY INFORMATION

### Overview

Before operating the TOHATSU fire pump thoroughly read this manual. Understanding proper operating procedures including “DANGER”, “WARNING”, “CAUTION” and “NOTE”.

These notices are designed to bring attention to very important information necessary to ensure safe, trouble free operation.

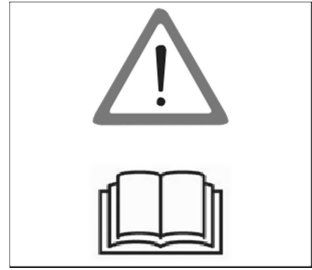

### Warning sign meaning

This sign is used for safety-related instructions in this manual.

Be sure to follow all safety-related instructions, otherwise, personal injury may occur.



### Signal words



• Failure to observe will result in severe personal injury or death.



• Failure to observe could result in severe personal injury or death.



• Failure to observe could result in personal injury or property damage.

- This instruction provides special information to facilitate the use or maintenance of the pump or to clarify important points.
- For attaching position of the warning label, refer to the “CONTENT 3. LABELS”.
- **Warning labels should be read clearly at any time.**

**If the display of the warning label becomes difficult to be read, it was almost come off, you must replace paste immediately.**

### Safety-related instructions and warning signs

Read and follow the safety-related instructions described in this manual and all warning signs on the portable fire pump thoroughly.

Always keep the warning signs in a legible condition. If any warning sign becomes illegible or detached, replace it immediately.

## Transporting the portable fire pump

### ⚠ CAUTION

- Retractable handle is folding type.
- Do not put hand or finger between top of retractable handle and bracket.
- When transporting the portable fire pump, assign one person per handle.
- Also, when you transport the portable fire pump, it should be transported holding the handle firmly.
- There is a risk of injury to the leg by all.



## Durability of protection

When you purchase a new pump, it is placed in packing box and protected.

## Storage of pump after transportation

Keep the pump away from high humidity, and place it on a horizontal plane.

## Disposal of packing box

Dispose the packing box by following the environmental laws.

## Emissions

Noise emission values

For noise emission values, refer to "CONTENT 17. APPENDIX".

### ⚠ CAUTION

- Wear proper hearing protection during operation.



## Exhaust gas

Exhaust gas emitted from the engine contains carbon monoxide (CO) etc. that may seriously affect human health.

Do not operate the engine in a room, car, warehouse, tunnel, or other closed locations that have poor ventilation.

Mortal danger due to carbon monoxide (CO) poisoning causes.





## Safety devices

Before operating this portable fire pump, be sure to check that all the safety devices have been installed in the appropriate positions.

Before removing the safety devices, turn the main switch off.



After protective devices have been disassembled as part of servicing and maintenance work, immediately install them back to their original locations, making sure that they are in safe and secure condition.



Check the portable fire pump visually and functionally on a regular basis.

If a failed device or equipment is found, remove it immediately, and repair or replace it, if necessary. Failure to do so may cause an accident.

After it has been repaired or replaced, make sure that it functions correctly.



## Protective clothing Protective equipment

During fire extinguishing training or regular firefighting services, wear normal protective clothing and equipment to protect your body.

- Fireproof protective clothing
- Fireproof helmet
- Fireproof protective gloves
- Fireproof protective boots



## Service Maintenance

Servicing and maintenance of this fire pump must be carried out by only the persons who have professional knowledge, who are familiar with the device, and who understand laws and regulations regarding safety and accident prevention.

Before starting maintenance work, turn the main switch off to stop the engine.

Disconnect the negative terminal of the battery.

Before starting maintenance work, securely place the portable fire pump on the ground.

In the case of just after stopping the engine, do not touch the exhaust pipe, the muffler and the other engine parts until these parts will be cold enough. These parts could be very hot and will cause severe burns.



## Electrical equipment

Only expert electricians or trained staff members should handle electrical equipment.

When disconnecting the cable from the battery, disconnect the negative (-) cable first.

When connecting the cable to the battery, be sure to connect the positive (+) cable first. After that, connect the negative (-) cable.

Do not place any metal on the top of or around the battery. Doing so may cause a short circuit.

Use a fuse with the same specifications as the original one when replacing it. Using a fuse that has a greater capacity than the rated value may damage the equipment.

Check the electrical equipment of the fire pump on a regular basis.

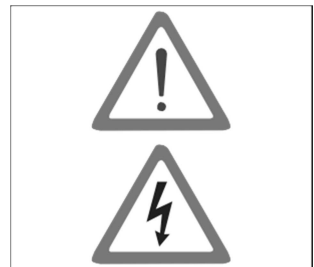
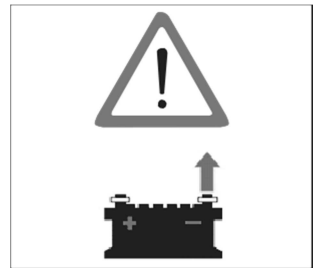

## Battery

Follow any safety-related instructions shown on the battery.

The battery can generate flammable hydrogen gas that may **cause an explosion**.

Do not charge the battery in closed location.

Do not smoke around the battery.

The battery electrolyte is **caustic and may cause personal injuries**.

- Always wear protective clothing.
- Always wear protective gloves.
- Always wear protective glasses.
- Do not tilt the battery. Doing so may cause the battery electrolyte to leak out from the vent hole.



## Handling of fuel

Exercise care when handling fuel. Failure to do so may cause fire.

Do not bring any flames near fuel. Stop the engine before refueling. Do not smoke while refueling fuel.

Do not refill fuel in an enclosed room. Doing so may cause an explosion caused by fuel fumes.

If fuel spills, wipe it with a cloth or other material, and dispose of it according to relevant laws and regulations.



## Disposal

Dispose of disused batteries according to relevant laws and regulations.

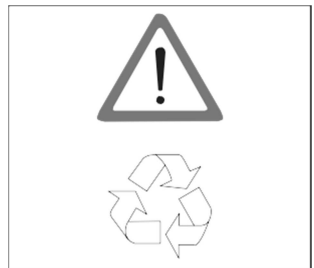

## Genuine parts

When replacing parts for servicing and maintenance of the portable fire pump, use only Tohatsu genuine parts.

If genuine Tohatsu parts and accessories are not used, it may adversely affect the functioning and safety of the fire pump. Use genuine Tohatsu parts only.

Tohatsu bears no responsibility for any personal injuries or equipment damage that may result from use of parts or accessories obtained from outside sources.

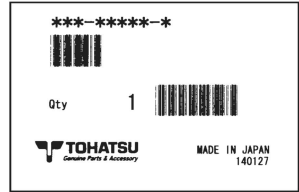

## Environmental protection measures

Dispose of oil, fuel, batteries, etc. according to relevant environmental laws.

Do not dump waste into the ground, water, or sewerage.

Store the fuel only in the specified container.

When disposing of parts, follow the correct disposal procedure.



## Water-prohibiting substance

Do not discharge water to water-prohibited substance.

## Use of water

Do not pump combustible liquids, chemical or caustic liquids.

---

## CONTENTS

---

1. SPECIFICATIONS.....	1
2. OPERATION DEVICE.....	4
3. LABELS.....	8
4. OPERATING PRECAUTIONS.....	9
5. DESCRIPTION OF DEVICES.....	11
6. PREPARATION FOR OPERATION.....	18
7. USE OF OPERATION PANEL.....	22
8. STARTING THE ENGINE.....	25
9. PRIME AND DISCHARGE.....	29
10. STOPPING THE ENGINE.....	35
11. MAINTENANCE AFTER OPERATION.....	36
12. MAINTENANCE IN COLD CONDITION.....	41
13. USE OF ACCESSORY.....	44
14. PERIODICAL INSPECTION.....	46
15. SERVICE AND MAINTENANCE.....	48
16. TROUBLESHOOTING.....	56
17. APPENDIX.....	63
18. TOOL AND STANDARD ACCESSORY.....	64
19. WIRING DIAGRAM.....	65

---

# 1. SPECIFICATIONS

---

Model	VE1500W
Description	Portable pump
Max. permissible inclination angle	During transport : 35° at all sides In operation : 15° at all sides
Max. operating pressure P alim	17 bar
Max. water temperature	+60 °C
Temperature range	-15 °C to +40 °C ambient temperature
Engine	
Manufacturer	TOHATSU CORPORATION
Model	2WT81A
Type	2-stroke, water cooled, spark ignition engine
Bore × Stroke	81 mm × 78 mm
Number of Cylinder	2
Piston displacement	804 cm <sup>3</sup>
Authorized output	60 PS (44 kW)
Fuel type	Unleaded petrol RON91
Fuel tank capacity	24 L
Fuel consumption *	22 L/h
Engine oil tank capacity	1.6 L
Ignition	C.D.I.
Spark plug	NGK BPR7HS-10
Starting system	Electric starter and Manual starter
Lubrication	Auto mixing
Fuel system	Electronic fuel injection
Battery	12 V-16 Ah/5 h , 12 V-18 Ah/10 h
Floodlight bulb	12 V-35 W

Remark: \*It is fuel consumption at the time of the standard discharge.

# 1. SPECIFICATIONS

Model	VE1500W
Primer	
Type	Rotary-vane vacuum pump (Oil less type)
Max. suction height	Approx. 9m
Pump	
Type	Single suction, single stage, centrifugal pump
Number of delivery outlet	2
Discharge port coupling	BSP thread 2-1/2" (65mm) male JIS fire thread (B-9912) 2-1/2" male
Suction port coupling	BSP thread 4" (100 mm) male JIS fire thread (B-9912) 3-1/2" (90mm)male
Pump performance (Suction height: 3 m)	2,050 L/min at 6 bar
	1,800 L/min at 8 bar
	1,500 L/min at 10 bar
Dimensions and weight	
Length x Width x Height	748 mm x 732 mm x 827 mm
Mass	104kg (dry) 124kg (ready for operation)

## Materials

Engine	
Crankcase, Cylinder, Cylinder head	Aluminum alloy
Crankshaft	Chromium-molybdenum steel
Connecting rod	Chromium-molybdenum steel
Piston	Aluminum alloy
Pump shaft	Chromium-molybdenum steel with metal plating
Muffler	Steel and Stainless
Pump	
Pump case, Pump cover	Aluminum alloy
Impeller	Aluminum alloy
Shaft seal	
Type	Mechanical seal

# 1. SPECIFICATIONS

## Performance Curve (VE1500W)

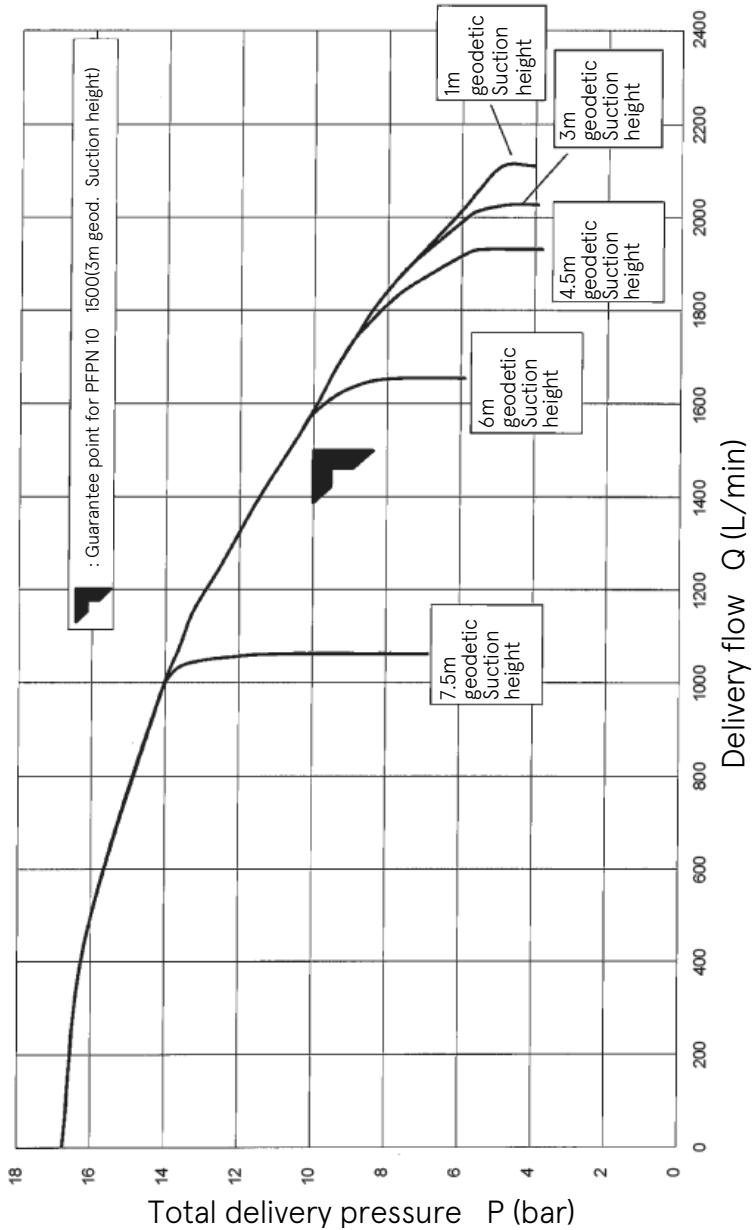



---

## 2. OPERATION DEVICE

---

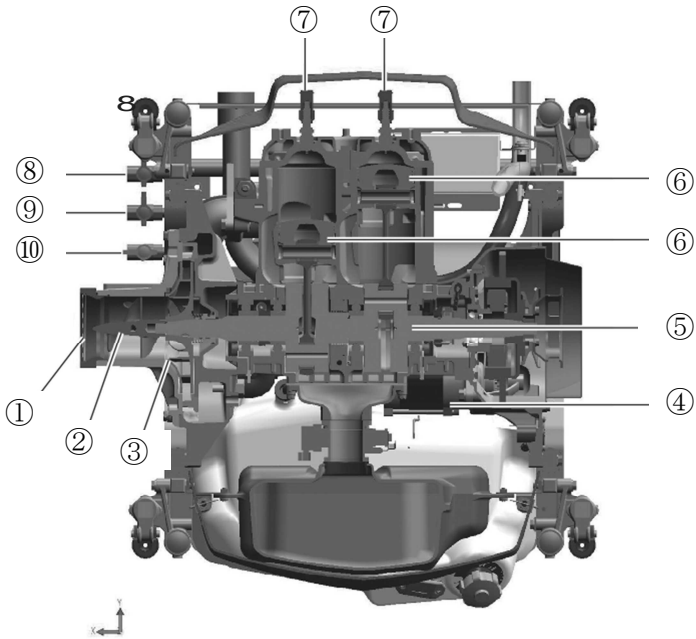

- ① Suction port
- ② Inducer
- ③ Impeller
- ④ Starter motor
- ⑤ Crankshaft
- ⑥ Piston
- ⑦ Spark plug
- ⑧ Cylinder drain valve
- ⑨ Pump drain valve
- ⑩ Muffler drain valve

---

## 2. OPERATION DEVICE

---

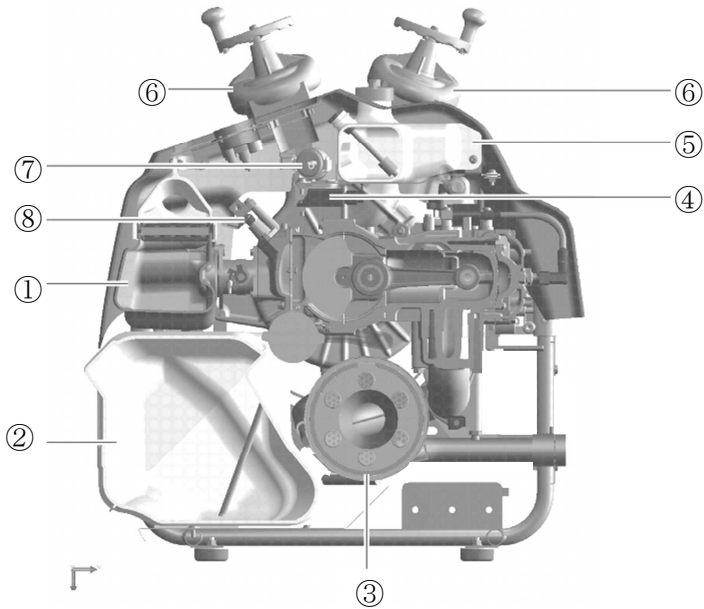

- ① Air silencer
- ② Fuel tank
- ③ Muffler
- ④ ECU
- ⑤ Oil tank
- ⑥ Discharge valve
- ⑦ Fuel feed pump
- ⑧ Injector

---

## 2. OPERATION DEVICE

---

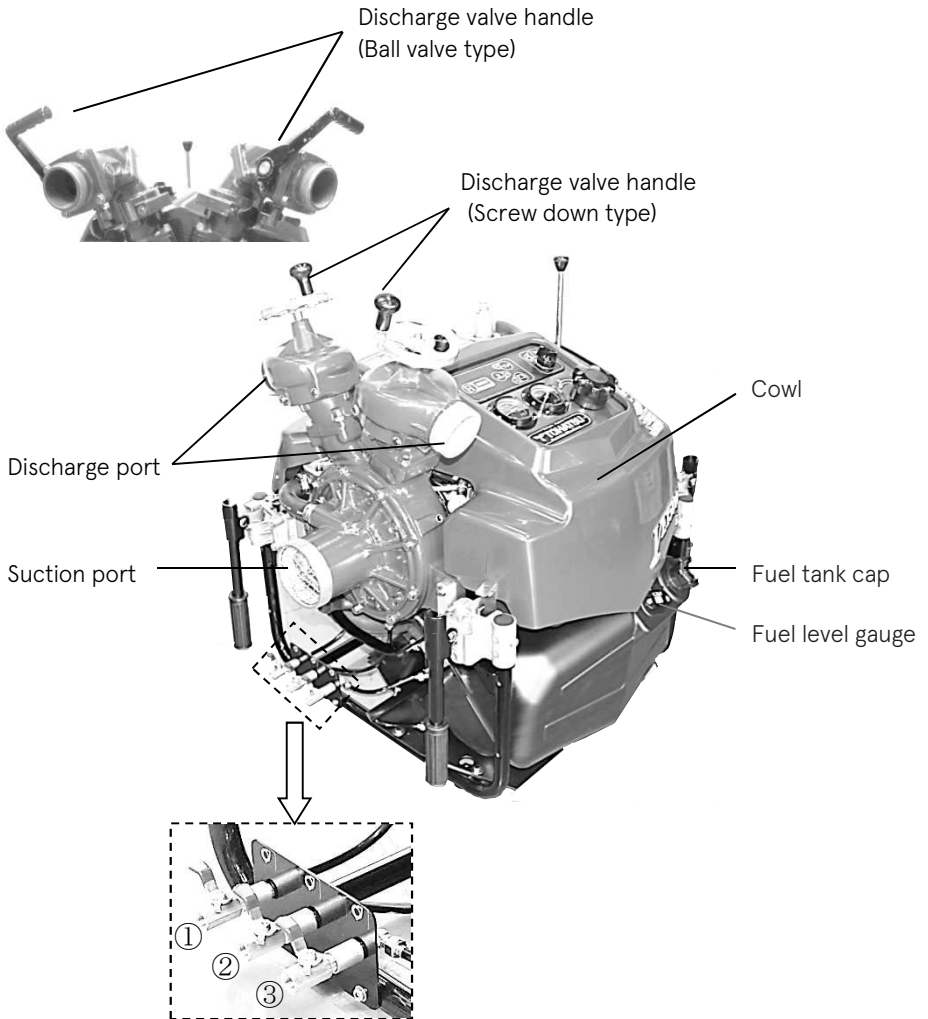

- ① Cylinder drain valve
- ② Pump drain valve
- ③ Muffler drain valve

## 2. OPERATION DEVICE

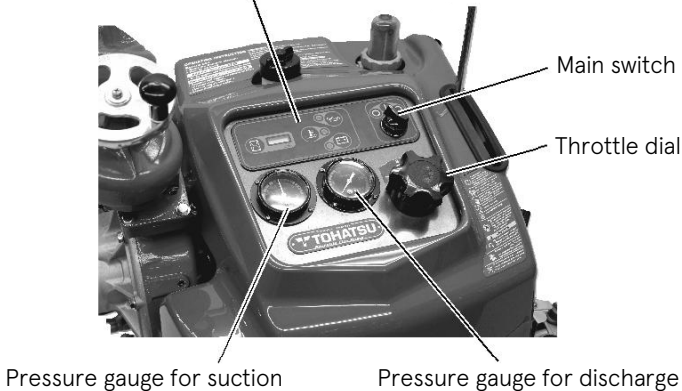
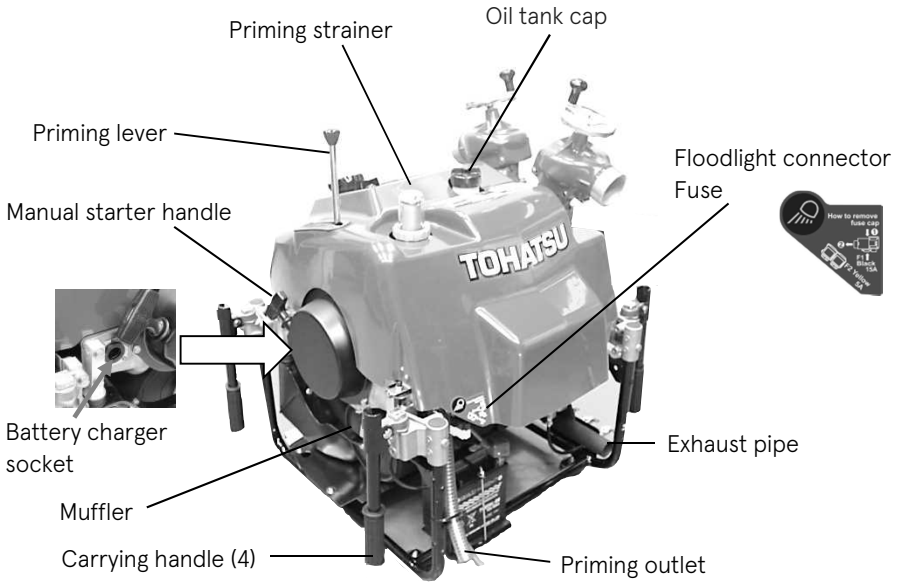

# 3. LABELS

Instruction

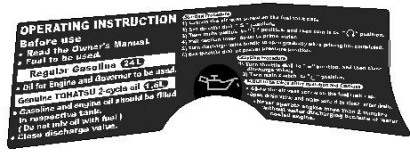

Warning Caution

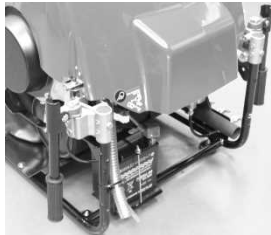

Warning



Warning

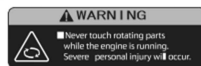

---

## 4. OPERATING PRECAUTIONS

---

### Installing pump



**CAUTION**

- The fire pump must be installed on level ground. Otherwise, an accident may occur. If the fire pump should be installed on uneven ground, it must be secured.
- When installing the portable pump in a vehicle, place the vehicle on a level place, and install the pump.
- When installing the portable pump in the vehicle, make sure to apply the brakes of the vehicle in order to stop the wheels.
- A serious accident may occur if the vehicle moves.
- Do not put your hands or fingers into the retractable part when operating the carrying handle.
- When transporting the portable fire pump, assign one person per handle. Also, when you transport the portable fire pump, it should be transported holding the handle firmly. There is a risk of injury to the leg by fall.
- Do not touch the exhaust pipe and the muffler while the engine is running, or for more than 10 minutes after the engine has been stopped.
- Confirm the engine temperature is cooled down enough. These parts are very hot and will cause severe burns.

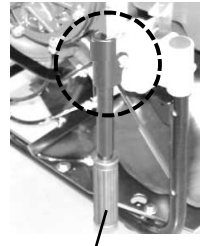

Carrying handle

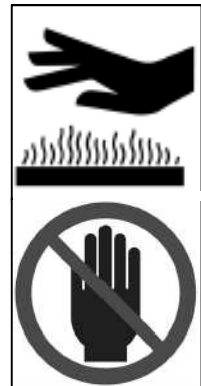

---

## 4. OPERATING PRECAUTIONS

---

<b>NOTE</b>
-------------

- Place the pump as near as possible to water source, and water suction height as low as possible.
- When lowering the portable fire pump to the ground, lower it gently and horizontally.
- Max. permissible inclination angle: 15°
- In case of the inclined or uneven location, make sure that water suction hose is lower than suction port of the pump.
- In case of the suction hose is put undulated, air can be left easily in the hose, and possibly causes suction inability when the water discharge valve is opened. In this case, set the water discharge valve half-opened, and operate vacuum pump until water is discharged continuously (for 3 to 5 seconds from beginning of water discharge).
- Be sure to install strainer and basket on the end of suction hose. If the pump may suck sand or mud on the bottom of water source, place sheet below the basket.
- Put the strainer and basket of suction hose into the water more than 30 cm from the surface to prevent suck of air.
- Discharge hose should be arranged not to be bent.
- When lowering the portable fire pump to the ground, lower it gently and horizontally.

## 5. DESCRIPTION OF DEVICES

### Suction port

The diameter of the thread for fire pump is

BSP thread 4" (100 mm)

JIS thread 3-1/2" (90 mm)

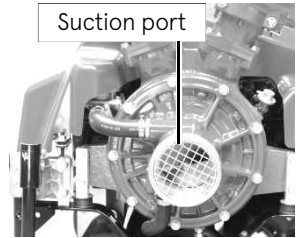

#### WARNING

- Putting a finger or a hand into the suction port while the pump is running without installing the strainer, it may be seriously damaged by the rotating inducer.

#### CAUTION

- Install the standard strainer to the suction port.
- Do not run the pump if the strainer is not installed.
- If the pump is operated without the strainer installed, gravel can enter the pump and the drainage capacity may be decreased considerably.



### Carrying handle

This fire pump is equipped with four carrying handles.

The handles can be manually folded, and opened by rotating them by 90 degrees.

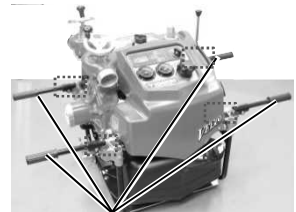

#### CAUTION

- Personal injuries may occur when opening or closing the handle.
- Do not put your hands or fingers into the retractable part when operating the handle.





---

## 5. DESCRIPTION OF DEVICES

---

### Priming lever

Used for suctioning water.

After starting the engine, pull the priming lever to suction water. After priming has been completed, return the priming lever to its original position.

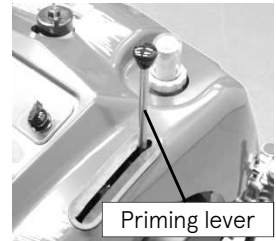

### Removing cowl

Cowl can be removed by releasing the 4 hooks up.

**NOTE**

- When removing the cowl, do not use excessive force, because the hook may be damaged.

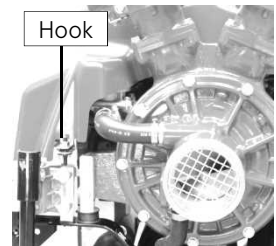

### Discharge port

The diameter of the thread for fire pump is

BSP thread 2-1/2" (65mm)

JIS fire thread (B-9912) 2-1/2" (65mm)

### Discharge valve

Use discharge valve handle for opening and closing the discharge valves.

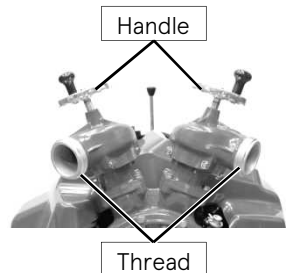

---

## 5. DESCRIPTION OF DEVICES

---

### Drain valve

Use the drain valves to drain water

#### NOTE

- Close all the valves when operating this fire pump.
- If a valve is opened, water cannot be suctioned.

Ⓐ Cylinder drain valve

Ⓑ Pump drain valve

Ⓒ Muffler drain valve

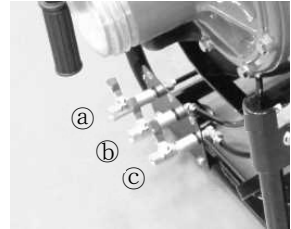

### Battery charger socket

Connect the battery charger plug to the socket.

<Specifications of accessory socket>

- Inner diameter (ID):  $\phi 21\text{mm}$
- Voltage: DC12V
- Max. allowable current: 5A

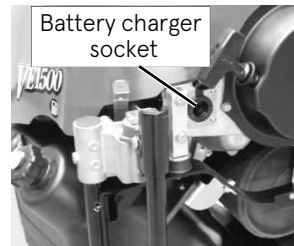

#### ⚠ CAUTION

- **Before charging the battery, turn the main switch OFF.**
- **When starting operation, be sure to remove the battery charger before turning the main switch ON.**
- **Socket is only for battery. Do not use socket for other purpose.**
- **Do not connect a cigarette lighter to the socket, because it is not a heat-resistant object.**

### Fuel tank

Airvent must be closed anytime.

#### ⚠ CAUTION

- **Do not tilt the pump with the air vent open. Otherwise, the fuel may leak.**
- **If the fuel leaks, wipe it off using a cloth or other materials.**

#### NOTE

- There is another air vent installed on the fuel tank.



## 5. DESCRIPTION OF DEVICES

### Control panel

The control panel is equipped with all the necessary operating and control instruments as follows.



### Throttle dial

Use the throttle dial to control discharge pressure.

“s” indicates the throttle position of engine start and priming.

### Pressure gauge for suction

The pressure gauge for suction indicates suction water pressure (negative pressure) and the input pressure supplied from an external water source.

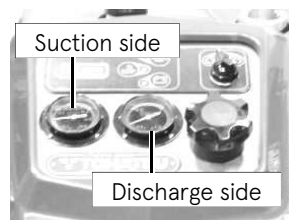

### Pressure gauge for discharge

The pressure gauge for discharge indicates the actual operating discharge pressure.

### Operation panel

The operation panel is equipped with main switch, all warning lamps and an hour meter.

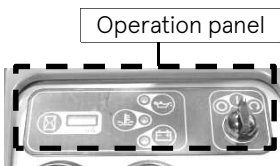

### Warning lamp and buzzer

Turning the main switch to “I” position, the check mode starts. The warning lamps light up and the buzzer sounds for a moment to enable to check those functions.

If the lamp and buzzer check mode shows failure, fix the cause referring to the troubleshooting section.

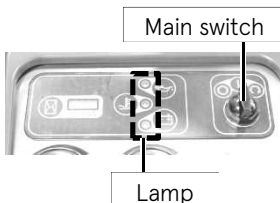

- CAUTION** • If they do not, remove the cause by following “CHAPTER 16 TROUBLESHOOTING”.

---

## 5. DESCRIPTION OF DEVICES

---

The monitor indicates the following information:

- Hour meter
- Low engine oil level warning
- Overheat warning
- Low charged battery warning

### Hour meter

Hour meter indicates the accumulated operation time of the fire pump.

#### NOTE

- Use it to check the running time and maintenance timing.

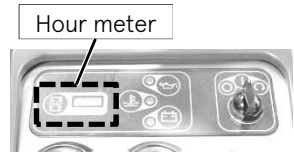

### Low engine oil level warning

If the engine oil level decreases below approximately 1/3 (0.5 L) of the full oil tank, warning lamp lights up and the warning buzzer sounds.

#### CAUTION

- **The engine does not stop even if the low engine oil level warning lamp lights up. This is to give priority to the continuation of fire fighting over protection of the engine. The engine remains operational for more than 30 minutes even after the warning lamp lights up. However, if the engine is operated for longer than this, it may stuck. Refill the oil immediately.**



### Overheat warning

If overheat is detected, overheat lamp lights up, the warning buzzer sounds and the engine stops automatically.

#### NOTE

- The engine stops automatically when the overheat is detected.

#### CAUTION

- **The engine may be damaged.**
- **Do not restart the engine soon after it has stopped running.**

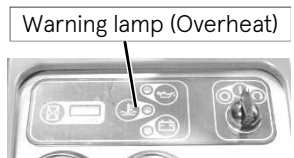

## 5. DESCRIPTION OF DEVICES

### Low battery charging warning

Battery voltage low warning lamp lights up when the battery voltage decreases below the limit.

Leaving the battery as it is, the battery will deteriorate, so please charge the battery as soon as possible.

#### NOTE





- The battery charge warning buzzer does not sound.



Warning lamp (Battery)

### Main switch

Main switch has three different functions.

Symbol	Function
	The switch is turned OFF.
	The switch is turned ON.
	The starter motor starts. When you release the switch, it returns to the “  ” position.

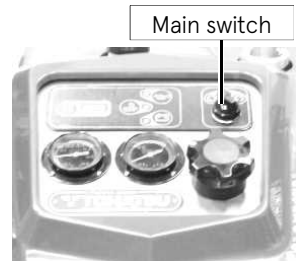

Main switch

### Engine oil tank

Engine oil tank cap is located as shown in the picture.



Oil tank cap

### Governor case

The governor oil level can be checked with the dipstick. Use the engine oil recommended by the engine manufacturer.



#### CAUTION

- **Be sure to stop the engine before checking the oil level. If you pull the dipstick when the engine is running, the oil may blow out.**

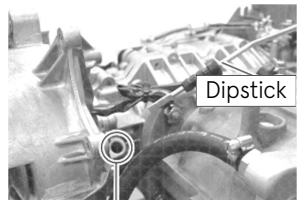

Dipstick

Governor oil filler port

---

## 5. DESCRIPTION OF DEVICES

---

### Manual starter

If the engine will not start with the starter motor, use the manual (recoil) starter.

**⚠ CAUTION**

- **Do not pull the manual starter handle when the pump is running. Otherwise, the manual starter may be damaged. Personal injuries may occur.**

**NOTE**

- To start the engine with manual starter, engage the manual starter ratchet by pulling the starter rope slowly. And then pull the starter handle quickly with great force from the position in which feeling harder resistance.

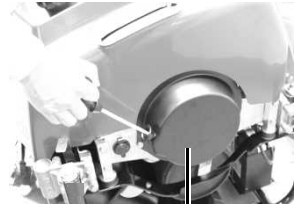

Manual (recoil) starter

### Mechanical governor

A built-in mechanical governor controls the throttle valve so that the maximum engine speed does not exceed 6000 r/min.

### Electric Safety Governor (ESG)

Designed as a system to assist the mechanical governor, the electric governor controls the engine speed by cutting off ignition so that the engine speed does not exceed 6100 r/min.

### Battery save control

If the engine is not started within 30 minutes of power ON, the power is automatically turned OFF.

### Anti-After Burn Control

This substantially reduces the “phenomenon that causes combustion inside the muffler (after burn)” by cutting the fuel injection in advance to purge the residual unburned gas in the engine when the engine is stopped.

---

## 6. PREPARATION FOR OPERATION

---

### Initial charge of battery

The battery can be used immediately after filling cells with electrolyte.

If the battery is maintenance free of electrode (Sealed type battery), do not open the battery after filling it with electrolyte. Refer to the INSTRUCTIONS of the battery.

### Fuel

Fill fuel until the maximum level of the gauge indicator (in Red).

- Fuel tank capacity: 24L



#### DANGER

- Vaporized fuel may cause ignition or an explosion.
- Do not bring any flames near fuel.
- Stop the engine before refilling fuel. Do not spill fuel.

#### CAUTION

- Do not breathe in petrol vapor!
- Petrol fumes are very toxic.
- After stopping the engine, do not touch it while it is hot.
- Refill fuel after the engine has cooled down.
- Fuel tank cap should be always tightly closed.  
Fuel tank cap should be removed only to fill fuel to the tank.
- Properly clean up all fuel spills (checking for gasoline vapor) before starting engine. If petrol or fuel spills, wipe it off using a cloth or other materials, and dispose of them according to the relevant laws and regulations.



---

## 6. PREPARATION FOR OPERATION

---

### NOTE

- Use of low-quality fuel results in a short engine life as well as starting difficulty and other engine problems.
- Fuel containing alcohol, methanol (methyl) or ethanol (ethyl), may cause:
  - Deterioration of rubber parts and plastic parts.
  - Starting, idling, and other engine performance problems.
- Do not use fuel that contains more than 10% ethanol or more than 5% methanol.
- Damages resulting from the use of fuel that contain alcohol are not covered under the limited warranty.

Air vent is installed on the fuel filler cap. Close the cap tightly after refilling.

Check that the air vent of the cap is closed.

### CAUTION

- **Do not tilt the pump with the air vent open. Otherwise, the fuel may leak.**
- **If the fuel leaks, wipe it off using a cloth or other materials.**



### NOTE

- The air vent is installed on the fuel tank, always close the air vent of the cap.

### Engine oil

Refill the 2-stroke engine oil to the oil tank.

### CAUTION

- **If different grades of engine oil are mixed, the oil may gel, which may result in oil filters becoming clogged. Be sure to use the same grade of engine oil.**



### 2-stroke engine oil

We recommend that using engine oil of ISO FB grade or higher.

- Engine oil tank capacity : 1.6L



---

## 6. PREPARATION FOR OPERATION

---

### Oil level sensor

The lamp on the operation panel will light when the level of engine oil tank has decreased approximate to 1/3 (0.5 L) of the tank. And also the warning buzzer will sound. Add 2-stroke engine oil.

### Governor oil

Before using fire pump, check governor oil level with the oil dipstick. To check oil level, remove the dipstick and check the oil level. The oil level should be between upper and lower limit line on the dipstick. Add 2-stroke engine oil through the governor oil filler port if the oil level is lower than the lower limit line.

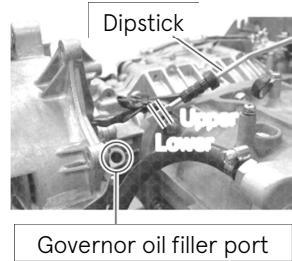

### Drain valves

Make sure the all drain valves are closed.

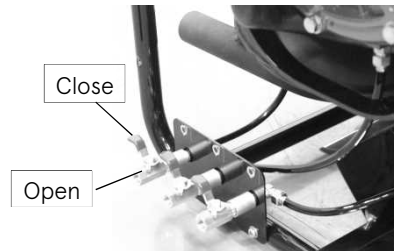

### Discharge valves

Make sure the discharge valves are closed.

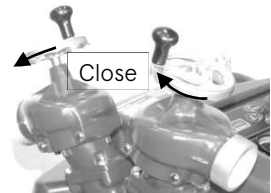

### Overheat protection sensor

This device shuts down the engine automatically when the engine has excessively overheated caused by lack of cooling water.

---

## 6. PREPARATION FOR OPERATION

---

### Overheat warning lamp

If the temperature of the engine rise approximately 90 °C or more, the engine will stop automatically to prevent overheating.

Warning lamp (Over heat)



### Warning lamp and sensor

When you turn the main switch to the "I" position, warning lamps light up for a moment to enable lamps to be checked, and the buzzer sounds.

Main switch

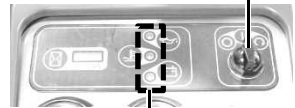

### CAUTION

- After the engine has stopped due to overheating, if you restart the engine immediately, engine may be burnt. Before restarting the engine, eliminate the cause.

(Refer to "Chapter 16 TROUBLESHOOTING").

Also check that the warning lamps are all turned off.

### Closed Circulating Water Cooling System

In this system, cooling water is taken from the suction water and pressurized by the pump, and returned to the water intake of the pump after cooling the engine and muffler.

## 7. USE OF OPERATION PANEL



### Alert action check (Lamp check)

When the warning lamps are off, there is no trouble on each function. When the warning lamps are on or blinking, the pump does not work properly.

#### NOTE

- When the power is turned ON, the warning lamp and buzzer will be activated for approximately one second, and the alert action check is automatically performed. After that, the installed computer starts monitoring.
- Set the main switch to the "1" position, and make sure the warning lamps light up and the warning buzzer sounds.

### Warning system

Alert		Warning indicator					Description of faults or notice	Remedy	
					High speed ESG	Warning buzzer			Engine operation
Alert check		One time flash	One time flash	One time flash		One time alert		Normal system test when main switch ON. (*2)	
Warning	Oil level	ON				ON		Oil level is below approx. 1/3	A
	Overheat		ON			ON	Stop	Engine has stopped due to insufficient cooling water, etc.	B
	Prior warning overheat		ON					Warning of engine stoppage due to insufficient coolant, etc. is sent in advance.	C
	Battery voltage			ON				Battery voltage is low	D
Engine over speed					ON			Engine speed exceeds maximum-allowable RPM(*3)	E
MAT or MAP Alert (*1)	Flashing							MAT or MAP failure or open circuit	F
TPS or WTS Alert (*1)		Flashing						TPS or WTS failure or open circuit	F

\*1. Manifold Air Temperature sensor (MAT), Manifold Absolute Pressure sensor (MAP), Throttle Position Sensor (TPS), and Water Temperature Sensor (WTS)

\*2. Turning the main switch to the "Operation" position

\*3. Engine speed is controlled to 6000 rpm

## 7. USE OF OPERATION PANEL

Engine status	Running	Overheating	Restart
80°C ↗	Light & Buzzer ON		Engine can start at less than 120°C and keep running for 30 seconds.
90°C ↗	Engine STOP		
70°C ↘	Light & Buzzer OFF		
Over 120°C	Engine STOP	Engine cannot start	

### Remedy

- A: Refill the engine oil.
- B: Remove the cause of insufficient cooling water and restart the engine.
- C: Remove the cause of insufficient cooling water.
- D: Charge the battery.
- E: Set the throttle dial to the “” mark position.
- F: Stop the engine and contact our customer service.

### NOTE

- System does not detect such overheat as caused by shortage of engine oil.
- Even if the engine oil warning buzzer sounds, the engine will not stop. The system is designed to make lifesaving the first priority.

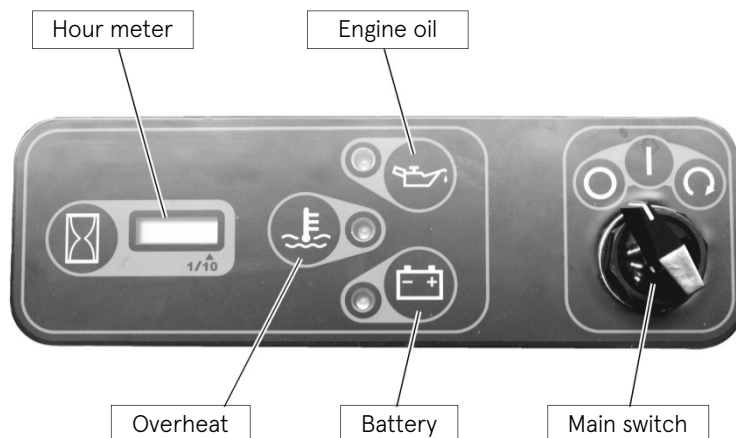

## 7. USE OF OPERATION PANEL

### Hour Meter

#### **⚠ DANGER**

- Before removing the electrical equipment, turn the main switch off and remove the battery.
- When removing the battery cable from the battery terminal, always disconnect the negative (-) cable first.
- When connecting battery cables, connect the positive (+) lead first.
- If the negative (-) lead is connected first, hydrogen gas generated by the battery may cause an explosion.
- Do not place any metal on the top or around the battery. Doing so may cause a short circuit.



1. The hour meter starts counting when main switch is set to the “**I**” position, even if the engine has not been started.
2. The hour meter only works during the main switch is on the “**I**” position.
3. There is no reset capability.
4. As this fire pump has “Battery save control”, the hour meter keeps counting for approximately 30 minutes.
5. When the engine stops due to overheating or other reasons, the hour meter counts if the main switch is set to the “**I**” position.

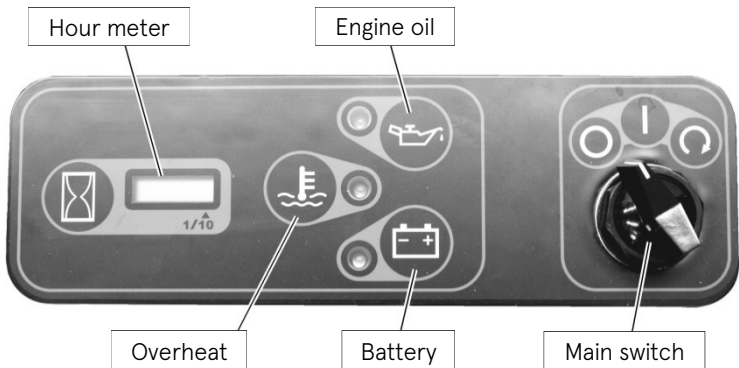

## 8. STARTING THE ENGINE

### Pump Installation

**⚠ WARNING**

- Since the temperature around the engine becomes high because of the muffler and exhaust gas, install the pump on level ground at least three meters away from inflammable materials including dead leaves and wood.
- Exhaust gas, which contains carbon monoxide, is a deadly poisonous gas with no color and no smell.
- Do not operate engine in a closed space or an insufficient ventilation place such as indoor, in the vehicle, warehouse, tunnel, well, in the hold of a ship.
- Do not start engine with discharge valve opened.
- Do not pump and discharge liquids other than water (e.g. flammable liquids or chemicals).
- This pump is only designed to pump up water.
- Do not discharge water to water-prohibiting substance.
- Do not run the pump without suction port strainer.
- If you insert your hand into the suction port, you may be seriously injured by the rotating inducer.

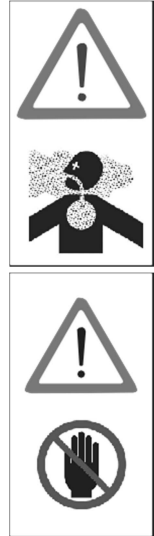

**⚠ CAUTION**

- Do not run the pump without suction port strainer.
- If gravel enters the pump, then the pump could be damaged and the performance would be significantly reduced.

1. Set the pump near water source on flat area.
2. Connect suction hose and delivery hose to the pump securely. Put end of suction hose in water source. The suction hose must have a strainer, and also must have a basket at the tip.
3. When water is discharged through branch pipe and nozzle, following diameter of nozzles is recommended.

Largest Nozzle Dia. (mm) *	
Twin outlet discharging	Single outlet discharging
25	36

Remark: \* The largest nozzle dia. at 3 m of suction head.

## 8. STARTING THE ENGINE

### Remove air from the fuel line

Before initially fueling this portable pump or restarting the engine after the engine stopped due to lack of gas, bleed air from the fuel line.

1. Turn the main switch from the "0" position to the "I" position and wait approximately 15 seconds

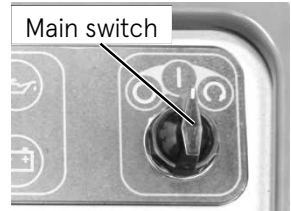

#### NOTE

- During this period, the electric fuel pump works and remove air from the fuel line.

2. Repeat this operation 2 ~ 3 times, and then start the engine.



#### CAUTION

- **Wear proper hearing protection during operation.**



- **While engine is running, never touch the high voltage ignition wire attached to spark plug. The wire carries very high voltage which will cause injury and bodily harm.**



- **Do not operate the pump on dry grass. The exhaust system will be very hot and could cause the dry grass burnt and fire. Clear the area if necessary.**



## 8. STARTING THE ENGINE

### Starting engine

1. Check that the air vent of the fuel tank is closed.



2. Turn the throttle dial at “S” mark position.

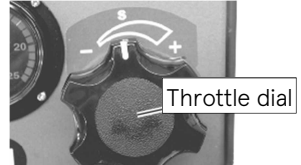

3. Turn the main switch to “O” position.

Release the main switch immediately after the engine starts.

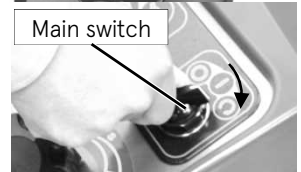

#### NOTE

- When the starter motor is operated for a long time continuously, the power of the battery will be exhausted. The maximum time for starting motor operation is 3 seconds at one time. If the engine does not start up, wait for 5 seconds before operating the starter motor again.
- Do not operate the starter motor after engine started.
- If the starter motor does not work, check that the battery terminals are tightly connected and the battery is fully charged.

### Starting engine using a manual starter

If electric starter does not work, use a manual starter as shown in the picture.

1. Turn the main switch to “I” position.

2. Turn the throttle dial to “S” mark position.

3. Engage the manual starter ratchet by pulling the starter rope slowly. And then pull the starter handle quickly with great force from the position in which feeling harder resistance.





---

## 8. STARTING THE ENGINE

---

### Dry operation

This portable pump has outsource cooling system, limit the duration of dry operation so that it is within the following time periods.

Performing dry operation longer than the specified time period may cause damage to the engine or pump.

- In the case of Idling: Within 2 minutes
- In the case of running with throttle dial at “**S**” mark position: Within 30 seconds

### Closed discharge valves operation after priming water

When the pump is operated with the discharge valve closed, the cooling water temperature becomes high.



- **Discharge water promptly. If the water discharge valve is kept closed, the water temperature inside the engine rises and the engine may overheat.**

## 9. PRIME AND DISCHARGE

### WARNING

- While the engine is running with the cowl removed, do not touch the rotating parts of the pulley or belt. This may cause personal injuries.



### NOTE

If, when operating the vacuum pump for 30 seconds, the pump does not suck up water, or if the pump cannot keep the water in it during the water discharge operation, check the following:

- Is the tip of the suction hose completely below the water surface?
- Is air sucked through the joint of the suction hose?
- Is the suction hose damaged?
- Does the vacuum performance of the priming pump reduced significantly?
- Does the pump case leaking vacuum?
- Does a vacuum leak occur when the pump is connected with the suction hose of which the opening is capped?

Refer to “Chapter 16 TROUBLESHOOTING”.

1. After starting the engine, pull down the priming lever.
2. Check that the pumped water is discharged from the priming outlet of the vacuum pump and check pressure gauge shows positive side.



3. Return the priming lever to the original position.



## 9. PRIME AND DISCHARGE

### NOTE

- Limit the vacuum pump operating time within 30 seconds. If the pump cannot suction water within 30 seconds, it may have been caused by another problem.

Refer to “Chapter 16 TROUBLE SHOOTING” to rectify the problem

4. Open the discharge valve.

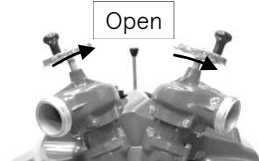
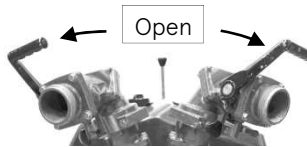

### CAUTION

- **Check that the nozzle is ready to discharge water before opening the discharge valve.**

### NOTE

- In order to avoid the occurrence of air pockets, connect the suction hose to the pump so that the pump is on upward location of the suction hose.
- If there is unevenness on the suction hose connected to the pump, air will be trapped in the hose. In this case, the pump may not be able to discharge the water when you open the discharge valve by the air in the hose.
- In this case, open the discharge valve and operate the vacuum pump for 3 to 5 seconds until the water is continuously discharged.



5. Adjust the water volume and pressure using the throttle dial.



---

## 9. PRIME AND DISCHARGE

---

### Performing relayed water supply (when sucking water from fire hydrant)

1. Determine the pump pressure in consideration of the water discharge pressure (nozzle pressure), hose pressure (friction) loss, and height loss.

$$\text{Pump pressure} = \text{needed pressure} + \text{friction loss} + \text{height loss}$$

2. Foreign materials such as dirt, gravel, iron rust, etc. may have intruded into a fire hydrant. Before connecting a hose, open a fire hydrant to discharge water in order to remove foreign materials.
3. When sucking water from a fire hydrant, use a mediation metal to connect a delivery hose to the suction port without using the suction hose in principle.
4. Set the discharge valve handle of the pump to the full open position.
5. Gradually open the fire hydrant on-off valve for the full open position. However, check the water pressure from fire hydrant with suction pressure gauge on the pump and adjust the opening of fire hydrant, if necessary.



#### **CAUTION**

- **In the case of water pressure from fire hydrant is higher than 6 bar, do not continue to open the fire hydrant on-off valve.**

\* In case of the water pressure from fire hydrant is higher than the required discharge pressure, it is not necessary to start the pump. If the water pressure from fire hydrant has not reached the required pump pressure, start the engine.

6. If the water pressure from fire hydrant is insufficient, start the engine and adjust the pressure to the required level by operating the throttle dial.  
Stop increasing discharge pressure if the suction pressure gauge shows 1bar or below. If it does, stop increasing the pressure and keep the throttle dial as it is.
7. To end discharging water, turn the throttle dial to the low pressure firstly, then stop the engine, and close the fire hydrant on-off valve.



#### **CAUTION**

- **Be sure not to close the discharge valves and nozzle(s) of any pumps until all the pumps stop and the fire hydrant on-off valve is closed.**

8. Set the discharge valve to the half-open position, and open all the drain valves to drain the remaining water as maintenance after operation.

## 9. PRIME AND DISCHARGE

### Relay pumping operations



- In the case of relay pumping operations training in a flat place, if the number of extending hose is less than ten, use the Safety nozzle attached.

Discharge port adaptor

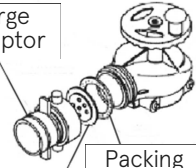

Packing

Pumping plate  
(Standard accessory)  
Part No.151-39045-1

### Description of relay pumping operation

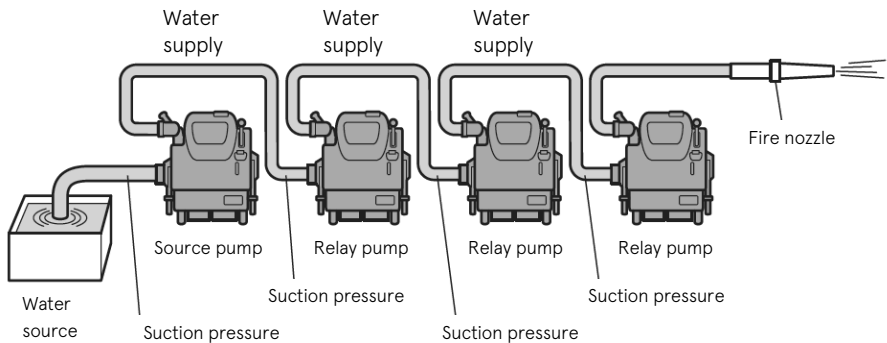
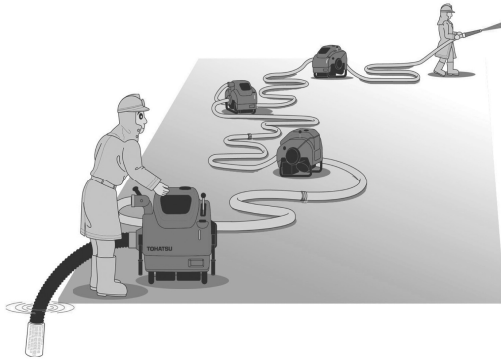

---

## 9. PRIME AND DISCHARGE

---

### Preparation for operation



• **Never close the discharge valve of source pump and the relay pump(s), and the fire nozzle(s). If the discharge valves or nozzle is (are) closed, there will be a risk of damage to the pumps and hoses with excessive pressure or water hammer.**

1. Decide how many relay pumps are needed in consideration of the distance and height between the water source and the fire ground.
2. Place the pumps according to the decision, and then connect the hoses.
3. Make sure that the discharge valves are open, including the fire nozzle.
4. Decide the discharge pressure of each pump in consideration of needed pressure for next pump (or fire nozzle) and the friction loss and height loss.

$$\text{Pump pressure} = \text{needed pressure} + \text{friction loss} + \text{height loss}$$

### Start the Source Pump

Once the water supply has started, keep supplying it until finished. If reducing or stopping water supply, overheat or cavitation may occur in the relay pump(s).

1. Start the source pump according to "Chapter 8 ENGINE START".
2. Start supplying water according to "Chapter 9 PRIME AND DISCHARGE".

### Start the Relay Pump

1. Make sure that the discharge valve is opened and wait for the water supplied.
2. Check that the water was supplied from the source pump. At first, the hose swells due to air pressure. Step on a hose to judge whether the swelling of the hose is due to water or air.
3. When the water is supplied to the pump, check the pressure of the gauge. Start the engine when it is lower than the decided pressure. If the pressure is higher than the decided pressure, no need to start the engine.
4. Adjust the discharge pressure with the throttle dial. The suction pressure decreases with throttle dial up (Increase discharge water). Always check it with a suction pressure gauge.
5. If the suction pressure decreases below 1 bar, order the operator of the pre-stage pump to increase the water pressure, and adjust the relay pump pressure by the throttle.
6. When the suction pressure rises, adjust the water pressure by the throttle dial again.

---

## 9. PRIME AND DISCHARGE

---

### **Start the Attack Pump**

Same as the relay pump operation.

### **Finish the relay Pumping Operations**

- Stop the attack pump running first.
- Stop the relay pump running from the pump closest the nozzle in order.
- Finally, stop the source pump.

## 10. STOPPING THE ENGINE

### CAUTION

- Do not touch the exhaust pipe and the muffler while the engine is running, or for 10 minutes after the engine has been stopped. These parts are very hot and will cause severe burns.



1. Return the throttle dial to “” position.



2. Close the discharge valves.

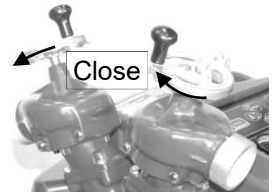

3. Turn the main switch to “” position.

### NOTE

- It takes one to three seconds until the engine stops due to the after burn control. This is a shut off behavior by an anti-after burn control, not a failure.





---

## 11. MAINTENANCE AFTER OPERATION

---

### Maintenance after pumping seawater or foul water

In case of the pumping seawater or foul water, the pump should be flushed out with fresh water immediately to prevent excessive corrosion. And operate the vacuum pump for 5 seconds at low engine speed ("I" position) in order to clean the vacuum pump.

### Drain water

1. Open the drain valves and check the water in the pump has been completely drained.
2. Close the all drain valves for next operation.

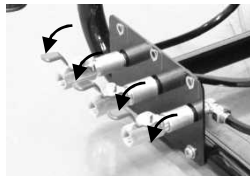

Open

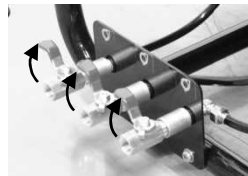

Close

### Check Suction Performance

1. Open the drain valves and check the water in the pump has been completely drained.
2. Close all the drain valves and install the suction port cap.

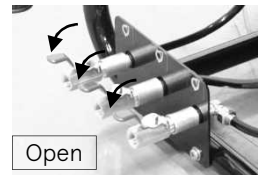

Open

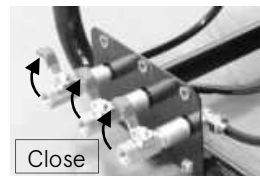

Close

#### NOTE

- Prepare a suction cap that is suitable for the suction coupling.

---

## 11. MAINTENANCE AFTER OPERATION

---

3. Start the engine, and turn the throttle dial to the “S” position. Operate the priming lever to produce a vacuum. (Priming water operation must be within 30 seconds)

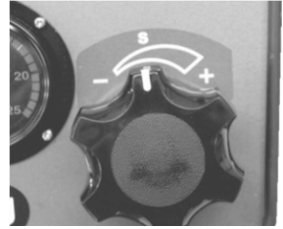

4. After a vacuum is produced, immediately return the priming lever to the original position, and stop the engine.



5. Check that the vacuum pressure of the pressure gauge for suction shows below -0.8 bar.

Pressure gauge for suction



6. In order to check that there is no vacuum leak, leave it for 30 seconds and confirm that the pointer of the pressure gauge for suction keeps the same pressure indication.

7. Open the drain valves to expose it to the atmosphere, and check that the pointer of the pressure gauge for suction returns to “0”.

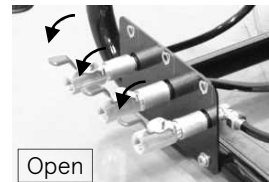

8. Close the drain valves.

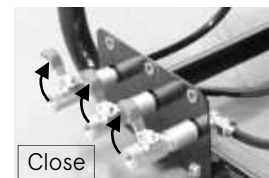

---

## 11. MAINTENANCE AFTER OPERATION

---

### Fuel and Oil Supply

#### 1. Fuel

Fill fuel until the maximum level of the gauge indicator (in red).

Fuel tank capacity: 24L



**CAUTION**

- Do not tilt the pump with the air vent open. Otherwise, the fuel may leak.

If the fuel leaks, wipe it off using a cloth or other materials.



#### 2. Engine oil

Fill the oil tank with engine oil full.

Engine oil tank capacity: 1.6L

**NOTE**

- Use 2-stroke engine oil of ISO FB grade or higher.



#### 3. Governor oil

Check the oil level using the dipstick.

**NOTE**

- Use 2-stroke engine oil of ISO FB grade or higher.
- The oil should be the same oil with the engine oil.



Governor oil filler port

---

## 11. MAINTENANCE AFTER OPERATION

---

### Cleaning strainer for priming water

Remove the ring nut and clean the strainer with fresh water. If the strainer is dirty with dust, etc., vacuum performance efficiency will be reduced.

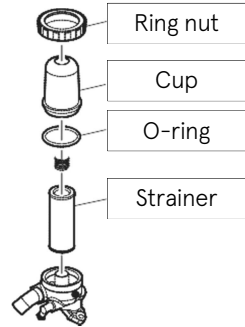

#### NOTE

- When assembling the strainer, tighten the ring nut while holding and pushing slightly the strainer cup.

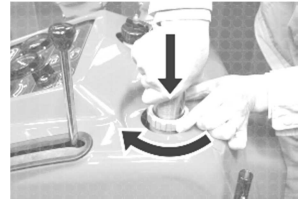

### Charging battery

#### NOTE

- Removed the cowl when replacing battery.
- Refer to "Chapter 15 SERVICE AND MAINTENANCE".

Make sure to charge the battery after each operation.

---

## 11. MAINTENANCE AFTER OPERATION

---

### Battery charger

 **CAUTION**

- Use an automatic battery charger.
- Use a maintenance-free (MF) battery.
- The battery capacity must be 12V-16Ah/5h (12V-18Ah/10h).
- Use a battery charger that has an overcharge prevention function.
- Disconnect the battery charger after charging is completed.

1. When charging the battery, set the main switch to the “” position.

 **WARNING**

- Do not connect a cigarette lighter to the battery charger socket. Doing so may melt or burn out the socket due to overheating.

**NOTE**

- If the switch is set to the “” position, the battery cannot be charged because the charging circuit is turned OFF.

2. When you set the main switch to the “” position, check that the Low Battery warning lamp goes out after alert action check.

## 12. MAINTENANCE IN COLD CONDITION

### Infuse antifreeze



- If the temperature around the pump could be subzero, the pump inside may freeze up. It may cause not only the damage in the pump, but also the inability to start the engine.

### For pump unit

1. Open the drain valves (a), (b), (c).

Drain all the water from the pump.

- (a) Cylinder drain valve
- (b) Pump drain valve
- (c) Muffler drain valve
- (d) Discharge valve (Ball valve type)  
\* Turn the handles to the middle.

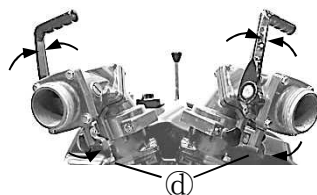
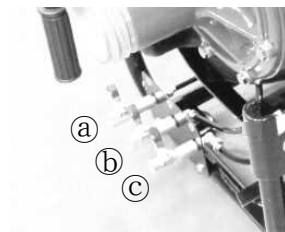

2. Close the drain valves (a), (c), (d) and the discharge valve handles.

3. Attach the vinyl pipe (standard accessory) to the drain valve (b).

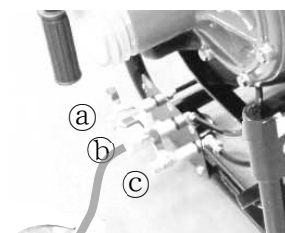

4. Insert the vinyl pipe in the container filled with anti-freezing fluid (180 ~ 200 mL).



5. Turn the throttle dial to "S" mark position.

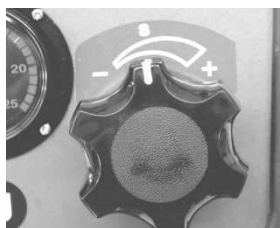

## 12. MAINTENANCE IN COLD CONDITION

6. Turn the main switch to “” position.

Release the main switch immediately after the engine starts.

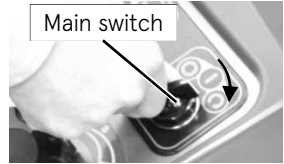

7. After starting the engine, pull down the priming lever.

8. Make sure the pressure gauge shows positive side.

### NOTE

- Even if anti-freezing fluid disappears, continue pulling a priming lever for 30 seconds.
- By this operation, anti-freezing fluid reaches every part of the pump.

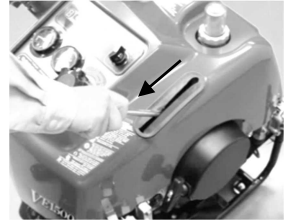



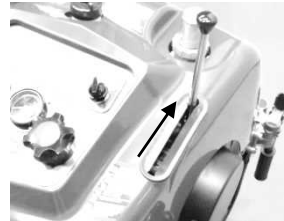



9. Return the priming to original position.



10. Stop the engine and close the drain valves.



### For primer

1. Turn the ring nut  while holding and pressing the strainer cup  of the primer, remove the strainer  and strainer cup .
2. Inject antifreeze (undiluted 50 ml) to strainer guide.
3. After injection, assemble the strainer cup  and strainer , and tighten the ring nut .

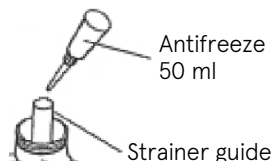
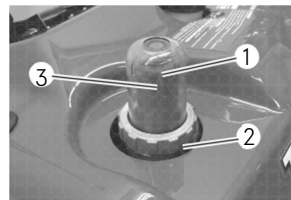

---

## 12. MAINTENANCE IN COLD CONDITION

---

- **When installing the strainer, exercise care so that the O-ring does not get caught in, and tighten the ring nut securely. If the ring nut is not tightened completely, a vacuum leak may occur.**
- When you install a strainer, pay attention to the protrusion of the O-ring and install it correctly. Otherwise, a vacuum leak may occur.
- When installing a strainer, tighten the ring nut while pressing the cup with your palm.

### **Discharge valve**

Fill the inside of the discharge valve with antifreeze using a long nozzle containing antifreeze liquid.



## 13. USE OF ACCESSORY

### Battery

Battery performance deteriorates if the temperature goes down. Further, battery may freeze if the specific gravity is low.

#### CAUTION

- When charging batteries, be sure to use an automatic battery charger dedicated to sealed batteries.
- Use an automatic battery charger that matches the battery specifications. Use of a mismatched automatic battery charger may cause the battery to explode.
- Keep the battery surface clean.
- Battery life is normally 2~3 years even if battery is used properly. Replace with new battery every 2~3 years checking the deterioration of the charging performance.
- When connecting battery cables, positive (+) lead shall be connected first.  
(When disconnecting battery, remove the negative (-) lead first.)
- Battery electrolyte is a very caustic acid, which will cause severe burns to your skin and damage to clothing.
- Hydrogen gases emitted from the battery will also cause severe burns to skin and damage to clothing.
- Read instructions attached to the battery carefully before use.



---

## 13. USE OF ACCESSORY

---

### Pumping plate

**NOTE**

- When the pump is operated using a discharge nozzle that has a nozzle diameter greater than the maximum nozzle diameter, or without using a discharge nozzle, be sure to use the pumping plate. Otherwise the pump may break down due to cavitation or may overheat due to lack of cooling water.

Largest Nozzle Dia. (mm) *	
Twin outlet discharging	Single outlet discharging
25	36

Remark: \* The largest nozzle dia. at 3 m of suction head.

When the fire pump is used for water pumping device, such as pumping water out of a cellar, pumping plate must be installed to avoid engine overheating caused by lack of cooling water.

Install the pumping plate between the discharge port adaptor and the packing as shown in the figure on the right. With the pumping plate in place, the pump can be operated without a discharge nozzle, so that pressure for cooling water in pump is maintained at certain level.

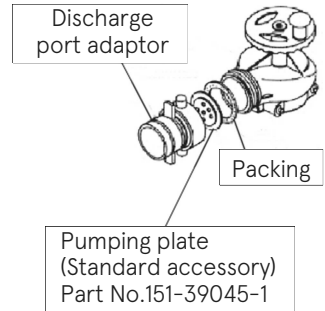

## 14. PERIODICAL INSPECTION

**Perform periodical inspections and maintenance according to the following procedures.**

Description		Inspection intervals				Inspection items	Measure
		After each operation	0.5 Year or 50 hr	1 Year or 100 hr	5 Years or 500 hr		
Fuel System	Fuel filter		●			Impurities (ie. Water and / or waste)	Clean out
			●			Impurities (If water has accumulated to filter)	Replace *1 Check high pressure filter, fuel tank and portable fuel tank.
	Fuel	●				Fuel level	Refuel
			●			Preservation period 6 month or more	Replace *1
			●			Degradation (ie. Stink or color)	Replace *1
			●			Impurities (ie. Water and /or water)	Replace *1
	Fuel hose		●			Curling, crack, leakage	Replace *1
High-pressure fuel filter				● Replace	—	Replace *1 *2	
Ignition	Spark plug		●			Fouling, wear, gap	Clean or replace
Engine	Cranking				●	<ul style="list-style-type: none"> <li>• Is not locked</li> <li>• Proper compression pressure</li> </ul>	Replace parts if necessary *1
	Engine oil	●				Oil level	Refill the same oil
	Governor oil		●			Oil level with oil dipstick	Refill
Starting System	Starter rope		●			Wear, damage	Replace *1
	Battery	●				Voltage measure	Charge
					● Replace	Period of use	Replace *1, 2

## 14. PERIODICAL INSPECTION

Description		Inspection intervals				Inspection items	Measure
		After each operation	0.5 year or 50 hr	1 year or 100 hr	3 years or 300 hr		
Priming system	V-Belt			●		Wear, crack, belt tension	Replace *1
	Strainer	●				Clogged or broken mesh	Clean or replace
	Primer	●				<ul style="list-style-type: none"> <li>• Is not locked</li> <li>• Check performance (-0.8 bar)</li> </ul>	Replace parts if necessary *1
		●				Air check	Check pump unit if necessary
Pump unit	Closed discharge valves operation after priming water		●			Check performance (10 bar)	Replace parts if necessary *1

\*1. Ask our customer service staff to replace the parts

\*2.  **WARNING** • Batteries that have been used for more than three years may explode if charged.

 **CAUTION** • Finish the performance test within one minute in order to protect the pump unit.

# 15. SERVICE AND MAINTENANCE

## General

Servicing and maintenance of the fire pump must only be carried out by personnel who have professional related knowledge and who are familiar with the fire pump and regulations regarding safety and accident prevention.

## Before starting maintenance work:

- Stop the engine.
- Disconnect the negative terminal of the battery.
- Place the pump on a level location.



## Safety Devices

 **CAUTION** • In the case of safety or protective devices have been disassembled as such part of servicing and maintenance work, immediately install them back to the original position after the maintenance. Make sure that it works without problems.

## Genuine parts

When replacing parts as part of servicing and maintenance of this fire pump, use only Tohatsu genuine parts.

If genuine Tohatsu parts and accessories are not used, it may adversely affect the functioning and safety of the fire pump. Therefore, for safety reasons, use only Tohatsu genuine parts.

Tohatsu bears no responsibility for any personal injuries or equipment damage that may result from use of parts or accessories obtained from outside sources.

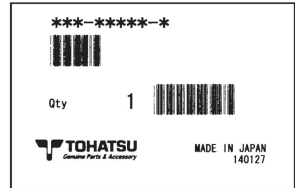

## Environmental protection measures

Dispose of oil, fuel, batteries, etc. according to relevant environmental laws in the region. Do not dump to nature or sewerage.



## Waste

When discarding parts, go waste in accordance with environmental laws in the region procedure.



---

## 15. SERVICE AND MAINTENANCE

---

### Removal and installation of cowl

#### Top cowl removal

1. Pull the cowl hook (front side 2 pieces), lift cowl slowly.

**CAUTION**

- Remove the cowl carefully without coming in contact with the priming lever and discharge valve.

2. Pull the cowl hook (total 4 hooks), remove the cowl completely.

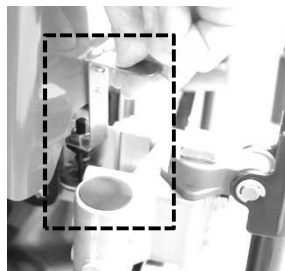

#### Top cowl installation

Assemble in reverse order of removal.

1. Fit the hooks to the plug holes on the front side. (2 places)
2. Through the vacuum pump lever, fit the plug to the hook (hole) on the front side. (2 places)
3. Put the plugs in completely while holding the cowl top.



### Vacuum pump strainer

#### Maintenance

**NOTE**

- Incorrect installation of the strainer may cause a vacuum leak. Be sure to install the strainer correctly.

Wash the strainer ① with fresh water after each use.

1. On the occasion of washing the strainer, turn the ring nut ② while holding the strainer cup ①. Remove the strainer cup ③ and the strainer ①.
2. Wash the strainer ① and the strainer cup ③.
3. After washing, assemble the strainer cup ③ and strainer ①, tighten with the ring nut ②.

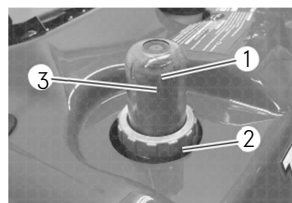

---

## 15. SERVICE AND MAINTENANCE

---

### Engine oil

Check the oil level.



- **Install the filler cap tightly each time you check the oil level.**

Check the oil level after each operation.

1. Place the pump in a horizontal location.
2. Open the oil tank cap and check the oil level.
3. Refill the oil until the lip of the oil tank.

### NOTE

- 2-stroke engine oil

We recommend that you use the engine oil of ISO FB grade or higher.



### Governor oil

Check every three months or every 50 hours operating time.

1. Place the pump on a level location.
2. Remove the oil dipstick, wipe it with a cloth.
3. Insert the oil dipstick completely.
4. Pull out the oil dipstick again, and check the oil level.

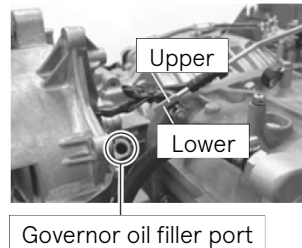

### Vacuum pump V belt

Check the V-belt.

Check the V-belt every year or every 100 hours operating.

V-belt size.....A-29

---

## 15. SERVICE AND MAINTENANCE

---

### Spark plug

Check the spark plugs

1. Remove the plug caps, and remove the spark plugs.
2. Use a wire brush or spark plug cleaner, clean the electrode of the spark plug ②.
3. Check the spark plug for excessive carbon deposit, electrode ② erosion and check the washer ③ for damage.
4. Measure the spark plug gap ①. If the gap is out of specification, replace the spark plug with the specified spark plug.

If necessary, adjust the gap to specification.

- Spark plug gap ① : 0.9–1.0 mm
- Usage limit : 1.2 mm
- Spark plug: NGK BP7HS-10

5. After assembling the spark plug, as far as by hand ①, using a plug wrench further tightening, tighten to the specified torque ②.

- Tightening torque : 27 N·m (20 lb·ft) [2.7 kgf·m]

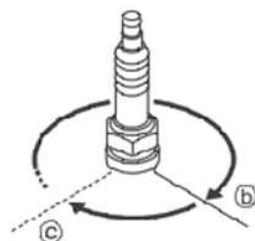
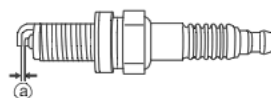
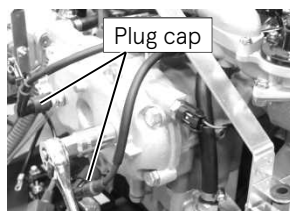



# 15. SERVICE AND MAINTENANCE

## Battery

### General safety information

Follow the safety instructions on the battery.

When charging batteries, a highly explosive oxyhydrogen gas mixture is produced.

Never charge a battery in a poorly ventilated place. Do not smoke near the battery.



### **⚠ DANGER**

**Danger of injury due to caustic substances of battery.**

- **Always wear protective clothing.**
- **Always wear protective gloves.**
- **Always wear protective glasses.**
- **Do not tip the battery, acid may be discharged from the air vents.**



### Disposal

Disused batteries should be disposed of according to local laws or regulations.

After each operation using the battery, check the voltage. Replace the battery if necessary.

1. Remove the muffler guard.
2. Disconnect the negative terminal of the battery cable first, disconnect the positive terminal next.

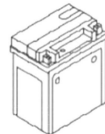

### **⚠ CAUTION**

- **There is a risk of injury.**
- **When handling the battery, be sure to wear safety glasses and protective gloves.**



---

## 15. SERVICE AND MAINTENANCE

---

### Electric equipment

Only expert electricians or trained staff members should handle electrical equipment.

Be sure to disconnect battery cables before handling electrical equipment. Disconnect the negative terminal first, and then disconnect the positive terminal.

When connecting battery cables, connect the positive terminal first, and connect the negative terminal.

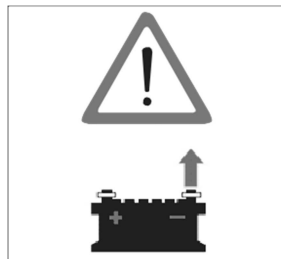

Use the fuse with the same current rating (ampere) as that of the installed fuse. Using a fuse that has excessively high resistance may result in electrical equipment failures.

### Fuse

Security fuses are installed in electrical circuits used in electrical equipment.

Before replacing the fuse, isolate the cause of the short circuit, and take the appropriate action.

After the appropriate action has been taken, replace the fuse with a new one.

Prepare the spare fuse at all times in case of emergency.

---

## 15. SERVICE AND MAINTENANCE

---

### Vacuum performance check

 **CAUTION**

- Limit continuous operating time of the vacuum pump to 30 seconds or less.
- Operating the pump for 30 seconds or more continuously may cause the engine to overheat. If the engine overheats, wait until it cools down, or perform the water discharge operation.
- The water discharge operation allows the cooling water to circulate to the engine and cool it.

1. Close (Cap) the suction port and then start the engine.

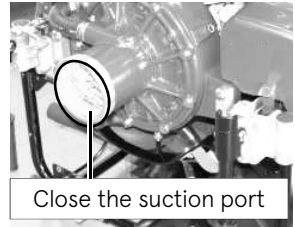

2. Pull the priming lever to run the primer (vacuum pump), and check that the pressure gauge for suction pointer reads approximately -0.8 bar.

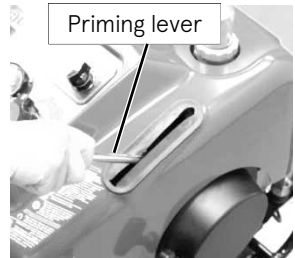

---

## 15. SERVICE AND MAINTENANCE

---

### Vacuum leak check

After completing the vacuum performance check, monitor the suction pressure indicated with the suction gauge for approximately 30 seconds to check for vacuum leaks. If the vacuum leak is found, isolate the cause by referring to the “Chapter 16 TROUBLESHOOTING”. Then, take the appropriate action and check the vacuum leak again.

### Water leak check

1. Connect one end of the suction hose to the suction port, put the other end of the hose in water, and then close discharge valve handle.
2. Start the engine, and pull priming lever to run the vacuum pump
3. Operate the throttle dial to raise the pump pressure almost to 1 MPa (10 bar), and then check for water leaks from each part of the pump and the cooling water piping.

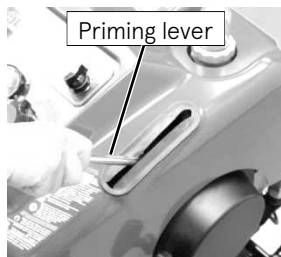
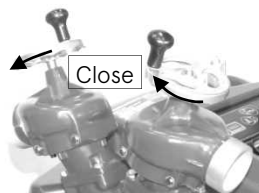

If the leak is found, isolate the cause by referring to “Chapter 16 TROUBLESHOOTING”. Then, take the appropriate action and check the vacuum leak again.

## 16. TROUBLESHOOTING

Typical causes of engine troubles are listed in the following tables.

	Trouble		Cause			Action
						Warning lamp flashing
						Floodlight, Gauge lamp, Hour meter, Warning lamp do not work
						Caused by engine unit Caused by Playpipe Caused by pump unit Caused by suction
						Water suction failure
						Air leaking
						Vacuum pressure defective
						Engine seizing
						Engine over heat
						Engine over-rev.
						Poor acceleration
						Idling is too high
						Rough idling
						Engine stumble or stall
						Engine start failure
						Starter motor does not work
						Battery charging failure
Fuel and Lubrication	Fuel shortage		●	●		Refuel.
	Deterioration of fuel		●	●	●	Replace with new fuel.
	Fuel tank air vent clogging		●	●	●	Clean the air vent.
	Fuel filter clogging		●	●	●	Clean the filter.
	Fuel pump failure		●	●	●	Replace.
	Injector failure		●	●	●	Replace.
	Fuel pipe kink or snap		●	●	●	Fix routing of the pipe.
	Throttle dial at other than "S" position		●			Set dial to "S" position.
	Oil filter clogging			●	●	Replace oil filter. (Do not fill it up with the different brand of oil.)

## 16. TROUBLESHOOTING

Trouble		Cause		Action			
Electrical	Warning lamp flashing					Plug in surely.	
	Floodlight, Gauge lamp, Hour meter, Warning lamp do not work					Replace with specified spark plug.	
	Insufficient water discharge	Caused by engine unit			●		Clean or replace with specified spark plug.
		Caused by playpipe				●	Check wire connection. Plug in surely. Replace parts if necessary.
		Caused by pump unit					Clean terminal and/ or tighten a terminal screw. Replace parts if necessary.
	Water suction failure	Caused by suction					Check 5A fuse and/ or battery charger. Replace parts if necessary.
	Air leaking						
	Vacuum pressure defective						
	Engine seizing						
	Engine over-heat			●	●		
	Engine over-rev						
	Poor acceleration						
	Idling is too high						
	Rough idling						
	Engine stumble or stall						
Engine start failure							
Starter motor does not work							
Battery charging failure							
	Spark plug cap comes off			●			
	Use of unspecified spark plug				●		
	Spark plug fouling (No spark or weak spark)			●			
	ECU and/or Sensors failure			●	●		
	Battery loose connection, terminal corrosion or expired	●	●				
	Battery charger defective	●					

## 16. TROUBLESHOOTING

Trouble		Cause		Action
Electrical				Warning lamp flashing Floodlight, Gauge lamp, Hour meter, Warning lamp do not work
				Caused by engine unit
				Caused by playpipe
				Caused by pump unit
				Caused by suction
				Water suction failure
				Air leaking
				Vacuum pressure defective
				Engine seizing
				Engine over heat
				Engine over-rev
				Poor acceleration
				Idling is too high
				Rough idling
				Engine stumble or stall
				Engine start failure
			Starter motor does not work	
			Battery charging failure	
	15A fuse blown	●		Replace with spare fuse. When the blowout of the fuse happens repeatedly, check a cause.
	5A fuse blown	●		15A: Battery cable reverse connection, operation panel components and search light connector 5A: Charging connector
	Starter motor defective		●	Check terminals, cords and screws. Replace parts if necessary.
	Operation panel defective	●	●	Check input of starter solenoid. (Equal to Operation panel output.) Replace parts if necessary.

## 16. TROUBLESHOOTING

Trouble		Cause		Action		
Compression	Piston, piston ring or cylinder excessively worn.	●		Correct or replace.		
	Carbon deposition in the combustion chamber		●	Clean out.		
	Suction	Suction height too high or length too long		●	Place the pump to nearer and/or lower position.	
		Suction hose end is not in water		● ● ● ●	Put the end of suction hose below 30cm of the water surface.	
		Suction hose coupling loose or gasket defective		● ● ● ●	Clean out a gasket and tighten securely. Replace a gasket if necessary.	
		Suction hose strainer clogged with dead leaves or waste etc.		● ●	Clean out.	
		Suction hose cracking or lining peeling off		● ● ● ●	Repair or replace.	
	Warning lamp flashing					
	Floodlight, Gauge lamp, Hour meter, Warning lamp do not work					
	Insufficient water discharge	Caused by engine unit	●			
		Caused by playpipe		●		
		Caused by pump unit				
	Caused by suction					
	Water suction failure					
	Air leaking					
Vacuum pressure defective						
Engine seizing	●					
Engine over heat		● ●				
Engine over-rev						
Poor acceleration	●					
Idling is too high						
Rough idling	●					
Engine stumble or stall	●					
Engine start failure	●					
Starter motor does not work						
Battery charging failure						



## 16. TROUBLESHOOTING

Trouble		Cause		Action		
Primer	Vacuum pipe loose or cracking		●		Tighten securely a clump of vacuum pipe or replace.	
	Strainer cap loose or O-ring failure		●	●	Tighten securely or replace.	
	V belt damaged or worn		●	●	Replace.	
	Vacuum pump rotor shaft seizing		●		Repair or replace.	
	Vane, Side plate worn or damaged		●	●	Replace.	
	Water stop valve	Water stop valve contamination		●	● ●	Clean out.
		Water stop valve diaphragm failure		●	● ●	Replace.
	Warning lamp flashing					
	Floodlight, Gauge lamp, Hour meter, Warning lamp do not work					
	Insufficient water discharge		Caused by engine unit			
			Caused by playpipe			
			Caused by pump unit			
	Water suction failure		Caused by suction			
Air leaking			●			
Vacuum pressure defective			●			
Engine seizing						
Engine over-heat						
Engine over-rev						
Poor acceleration						
Idling is too high						
Rough idling						
Engine stumble or stall						
Engine start failure						
Starter motor does not work						
Battery charging failure						

## 16. TROUBLESHOOTING

Trouble		Cause		Action		
Pump	Three drain valves are not closed			●	●	Close securely.
	Suction port strainer clogged with dead leaves or waste etc.				●	Clean out.
	Discharge valve imperfect open			●		Open securely.
	Gauge pipe connector loose or gasket defective			●	●	Tighten securely. Replace a gasket if necessary.
	Pump cover bolts loose			●	●	Tighten securely.
	Pump cover O-ring degradation			●	●	Clean out or replace.
	Impeller or Guide vane caught a stone or damaged			●		Clean or Replace.
	Mechanical seal damaged			●	●	Replace.
	Warning lamp flashing					
	Floodlight, Gauge lamp, Hour meter, Warning lamp do not work					
Insufficient water discharge	Caused by engine unit					
	Caused by playpipe					
	Caused by pump unit					
Water suction failure	Caused by suction					
	Air leaking			●	●	
Vacuum pressure defective			●			
Engine seizing						
Engine over heat						
Engine over-rev			●			
Poor acceleration						
Idling is too high						
Rough idling						
Engine stumble or stall						
Engine start failure						
Starter motor does not work						
Battery charging failure						

## 16. TROUBLESHOOTING

Trouble		Cause		Action	
Warning lamp flashing Floodlight, Gauge lamp, Hour meter, Warning lamp do not work	Insufficient water discharge	Caused by engine unit	●	Change the nozzle for suitable size or Incorporate safety nozzle.	
		Caused by playpipe	●		
		Caused by pump unit	●		
	Caused by suction			Clean out.	
	Water suction failure				
	Air leaking				
	Vacuum pressure defective			Adjust it securely.	
	Engine seizing	●	●		
	Engine over heat	●	●		
	Engine over-rev			Attach it securely	
	Poor acceleration	●	●		
	Idling is too high	●	●		
	Rough idling	●	●		
	Engine stumble or stall				
	Engine start failure	●			
Starter motor does not work					
Battery charging failure					

---

## 17. APPENDIX

---

### Tightening torque specifications

		M3	M4	M5	M6	M8	M10
Standard Bolt	N·m	0.7	1.6	3	6	13	27
	lb·ft	0.5	1.2	2	4	9	20
	kgf·m	0.07	0.16	0.3	0.6	1.3	2.7
Heat Treated Bolt	N·m				9	24	47
	lb·ft	-	-	-	7	17	34
	kgf·m				0.9	2.4	4.7

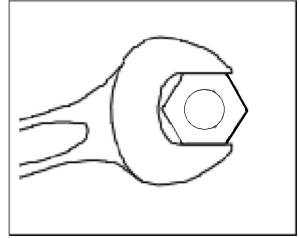

---

## 18. TOOL AND STANDARD ACCESSORY

---

### Standard accessory

Description	Quantity
Tool kit	1
• Tool kit bag	1
• Plug wrench	1
• Handle of plug wrench	1
Spark plug (BPR7HS-10)	1
Pumping plate	1
Fuse *15A	1
Fuse *5A	1
Vinyl pipe	1
Search Light (4P) (Floodlight)	1
Battery charger	1

\* Spare fuses are attached to fuse box.

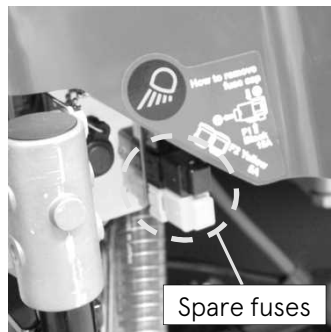

### Special tool

Description
Puller
Magneto puller assy
Impeller puller
Spring pin tool A
Spring pin tool B
Friction measuring tool

# 19. WIRING DIAGRAM

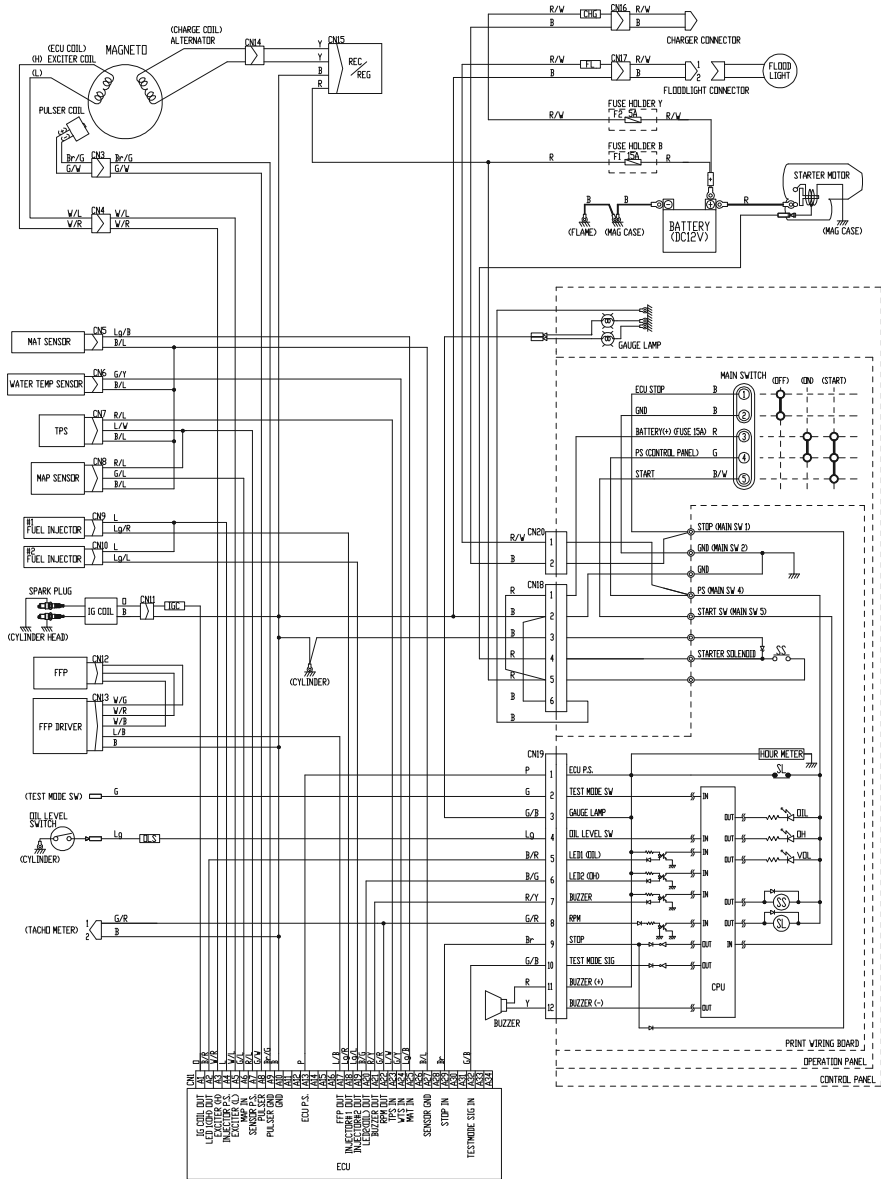

# OWNER'S MANUAL

## VE1500W

PORTABLE  
FIRE PUMP

No.003-12078-1

**TOHATSU CORPORATION**

5-4, Azusawa 3-Chome, Itabashi-Ku  
Tokyo 174-0051, Japan  
Phone: +81-3-3966-3137