

OWNER'S MANUAL

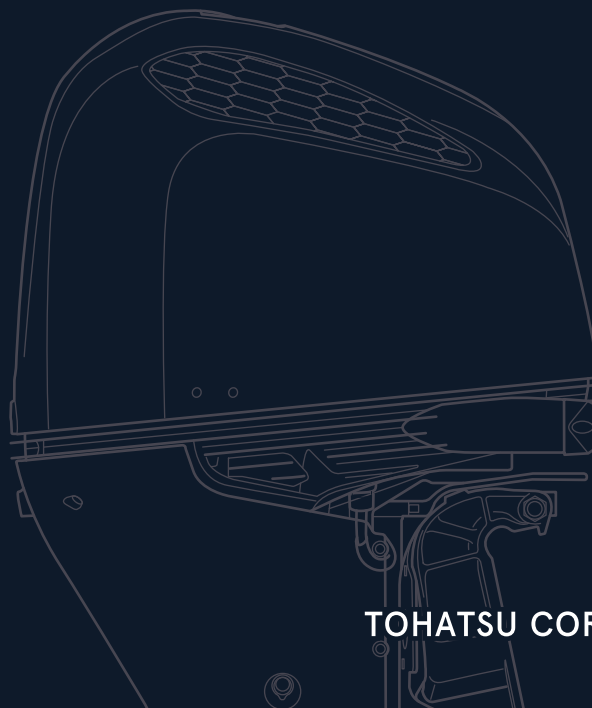

BFT200D
BFT225D
BFT250D



TOHATSU CORPORATION



WARNING:



The engine exhaust from this product contains chemicals known to the State of California to cause cancer, birth defects, or other reproductive harm.

Keep this Owner's Manual handy, so you can refer to it at any time. This Owner's Manual is considered a permanent part of the outboard motor and should remain with the outboard motor if resold.

INTRODUCTION

Congratulations on your selection of a TOHATSU outboard motor. We are certain you will be pleased with your purchase of one of the finest outboard motors on the market.

We want to help you get the best results from your new outboard motor and to operate it safely. This manual contains information on how to do that; please read it carefully.

As you read this manual you will find information preceded by a **NOTICE** symbol. That information is intended to help you avoid damage to your outboard motor, other property, or the environment.

We suggest you read the warranty policy to fully understand its coverage and your responsibilities of ownership.

When your outboard motor needs scheduled maintenance, keep in mind that your TOHATSU dealer is specially trained in servicing TOHATSU outboard motors. Your TOHATSU dealer is dedicated to your satisfaction and will be pleased to answer your questions and concerns.

Best Wishes,
Tohatsu Corporation

INTRODUCTION

A FEW WORDS ABOUT SAFETY

Your safety and the safety of others are very important. And using this outboard motor safely is an important responsibility.

To help you make informed decisions about safety, we have provided operating procedures and other information on labels and in this manual. This information alerts you to potential hazards that could hurt you or others.

Of course, it is not practical or possible to warn you about all the hazards associated with operating or maintaining an outboard motor. You must use your own good judgment.

You will find important safety information in a variety of forms, including:

- **Safety Labels** – on the outboard motor.
- **Safety Messages** – preceded by a safety alert symbol  and one of three signal words, DANGER, WARNING, or CAUTION.

These signal words mean:

 **DANGER**

You **WILL** be **KILLED** or **SERIOUSLY HURT** if you don't follow instructions.

 **WARNING**

You **CAN** be **KILLED** or **SERIOUSLY HURT** if you don't follow instructions.

 **CAUTION**

You **CAN** be **HURT** if you don't follow instructions.

- **Safety Headings** – such as *IMPORTANT SAFETY INFORMATION*.
- **Safety Section** – such as *OUTBOARD MOTOR SAFETY*.
- **Instructions** – how to use this outboard motor correctly and safely.

This entire manual is filled with important safety information – please read it carefully.

CONTENTS

OUTBOARD MOTOR SAFETY	7	Function Switches	
IMPORTANT SAFETY INFORMATION	7	(Single Top-Mount type (DBW type))	28
SAFETY LABEL LOCATION	9	Side-Mount Type	30
CONTROLS AND FEATURES	10	Ignition Switch	30
CONTROL AND FEATURE IDENTIFICATION		Emergency Stop Switch Clip and Emergency	
CODES	10	Stop Switch	31
HOW TO DETERMINE WHICH		Gearshift/Throttle Control Lever	31
DIRECTION THE PROPELLER SHAFT		Fast Idle Lever	33
ROTATES	11	Flush-Mount Type (Mechanical wire type)	33
COMPONENT AND CONTROL LOCATIONS ...	12	Ignition Switch	33
CONTROLS	21	Emergency Stop Switch Clip and Emergency	
Flush-Mount Type/Top-Mount Type		Stop Switch	34
(DBW type)	21	Gearshift/Throttle Control Lever	35
Ignition Switch		Fast Idle Button	36
(without START/STOP switch)	21	Top-Mount Type (Mechanical wire type)	37
Power Switch		Ignition Switch	37
(with START/STOP switch)	22	Emergency Stop Switch Clip and Emergency	
START/STOP Switch	23	Stop Switch	37
Emergency Stop Switch Clip and Emergency		Gearshift/Throttle Control Lever	38
Stop Switch	24	Fast Idle Button	39
Gearshift/Throttle Control Lever		Common Controls	40
(Flush-Mount type (DBW type))	25	Power Trim/Tilt Switch	40
Gearshift/Throttle Control Lever		PTT Switch Panel	42
(Top-Mount type (DBW type))	26	Power Tilt Switch	42
Function Switches		Manual Relief Valve	42
(Flush-Mount type)	27	Tilt Lock Lever	43
		Engine Cover Latch	43

CONTENTS

Trim Tab	43	INFREQUENT OR OCCASIONAL USE	55
INSTRUMENTS	44	STARTING THE ENGINE	56
Trim Meter (optional equipment)	44	Flush-Mount Type/Top-Mount Type	
Tachometer (optional equipment)	44	(DBW type)	56
NMEA Interface Coupler	44	Side-Mount Type	59
Operating Hour Notification System	45	Flush-mount type (Mechanical wire type)	62
INDICATORS	47	Top-Mount Type (Mechanical wire type)	64
Alternator (ACG) Indicator	47	Station Select Mode	67
Malfunction Indicator	48	STOPPING THE ENGINE	67
Oil Pressure Indicator	48	Emergency Engine Stopping	67
Overheat Indicator	49	Normal Engine Stopping	
Cooling System Indicator	49	(Flush-Mount Type, Top-Mount Type	
OTHER FEATURES	50	(DBW type))	68
Water Separator Buzzer	50	Normal Engine Stopping	
Rev Limiter	50	(Side-Mount Type, Flush-Mount Type,	
Anodes	50	Top-Mount Type (Mechanical wire type))	70
Fuel Priming Bulb	51	GEARSHIFT AND THROTTLE OPERATION	72
BEFORE OPERATION	52	STEERING	74
ARE YOU READY TO GET UNDERWAY?	52	CRUISING	75
IS YOUR OUTBOARD MOTOR		TROLLING MODE	78
READY TO GO?	52	ONE-LEVER MODE	79
OPERATION	54	SHALLOW WATER OPERATION	79
SAFE OPERATING PRECAUTIONS	54	MOORING, BEACHING, LAUNCHING	80
BREAK-IN PROCEDURE	54	MULTIPLE OUTBOARD MOTORS	81
FUEL PRIMING	55		

CONTENTS

SERVICING YOUR OUTBOARD MOTOR	82	CLEANING AND FLUSHING	107
THE IMPORTANCE OF MAINTENANCE	82	Cleaning and Flushing	107
MAINTENANCE SAFETY	83	STORAGE	109
TOOL KIT and OWNER'S MANUAL	84	Fuel	109
SPARE EMERGENCY STOP SWITCH CLIP	84	Engine Oil	111
MAINTENANCE SCHEDULE	85	HOISTING THE OUTBOARD MOTOR	112
TRIM TAB ADJUSTMENT	87	STORAGE PRECAUTIONS	112
MANUAL RELIEF VALVE	88	REMOVAL FROM STORAGE	113
ENGINE COVER REMOVAL AND		TRANSPORTING	114
INSTALLATION	88	WITH OUTBOARD MOTOR	
Engine Oil Level Check	89	INSTALLED ON BOAT	114
Engine Oil Change	91	WITH OUTBOARD MOTOR	
Oil Filter Change	92	REMOVED FROM BOAT	114
Engine Oil Recommendations	93		
Lubrication Points	94		
Spark Plug Service	95		
REFUELING	99		
FUEL RECOMMENDATIONS	100		
Fuel Filter with Water Separator Inspection and			
Replacement	100		
Anode Replacement	104		
Propeller Replacement	105		
Inspect After Operating	106		

CONTENTS

TAKING CARE OF UNEXPECTED PROBLEMS ...	115	CONSUMER INFORMATION	141
ENGINE WILL NOT START	115	Emission Control System Warranty	141
HARD STARTING OR STALLS AFTER		INDEX	146
STARTING	118		
ENGINE OVERHEATS	119		
FUSES	120		
Electric Starter Will Not Operate	120		
Battery Will Not Charge	120		
Fuse Replacement	120		
OIL PRESSURE INDICATOR TURNS OFF AND			
ENGINE SPEED IS LIMITED	123		
OVERHEAT INDICATOR COMES ON AND			
ENGINE SPEED IS LIMITED	124		
WATER SEPARATOR BUZZER SOUNDS	125		
SUBMERGED OUTBOARD MOTOR	126		
Emergency Gear Shifting (for DBW type)	128		
TECHNICAL INFORMATION	129		
Serial Number Locations	129		
Battery	130		
Emission Control System Information	131		
Star Label	134		
Specifications	136		

OUTBOARD MOTOR SAFETY

IMPORTANT SAFETY INFORMATION

The TOHATSU BFT200D, BFT225D, and BFT250D outboard motors are designed for use with boats that have a suitable manufacturer's power recommendation. Other uses can result in injury to the operator or damage to the outboard motor and other property.

Most injuries or property damage can be prevented if you follow all instructions in this manual and on the outboard motor. The most common hazards are discussed in this chapter, along with the best way to protect yourself and others.

Operator Responsibility

- It is the operator's responsibility to provide the necessary safeguards to protect people and property. Know how to stop the engine quickly in case of emergency. Understand the use of all controls.
- Stop the engine immediately if anyone falls overboard, and do not run the engine while the boat is near anyone in the water.
- Always stop the engine if you must leave the controls for any reason.
- Attach the emergency stop switch lanyard securely to the operator.
- Always wear a PFD (Personal Flotation Device) while on the boat.
- Familiarize yourself with all laws and regulations relating to boating and the use of outboard motors.
- Be sure that anyone who operates the outboard motor receives proper instruction.
- Be sure the outboard motor is properly mounted on the boat.
- Do not remove the engine cover while the engine is running.

OUTBOARD MOTOR SAFETY

Refuel With Care

- Gasoline is extremely flammable, and gasoline vapor can explode. Refuel outdoors, in a well-ventilated area, with the engine stopped. Never smoke near gasoline, and keep other flames and sparks away.
- Refuel carefully to avoid spilling fuel. Avoid overfilling the fuel tank.
- After refueling, tighten the filler cap securely. If any fuel is spilled, make sure the area is dry before starting the engine.

Carbon Monoxide Hazard

Exhaust contains poisonous carbon monoxide, a colorless, odorless gas. Breathing carbon monoxide can cause loss of consciousness and may lead to death.

If you run the engine in an area that is confined, or even partly enclosed, the air you breathe could contain a dangerous amount of exhaust gas.

Never run your outboard inside a garage or other enclosure.

WARNING

Running the engine of your outboard while in an enclosed or partially enclosed area can cause a rapid build-up of toxic carbon monoxide gas.

Breathing this colorless, odorless gas can quickly cause unconsciousness and lead to death.

Only run your outboard engine when it is located in a well ventilated area outdoors.

SAFETY LABEL LOCATION

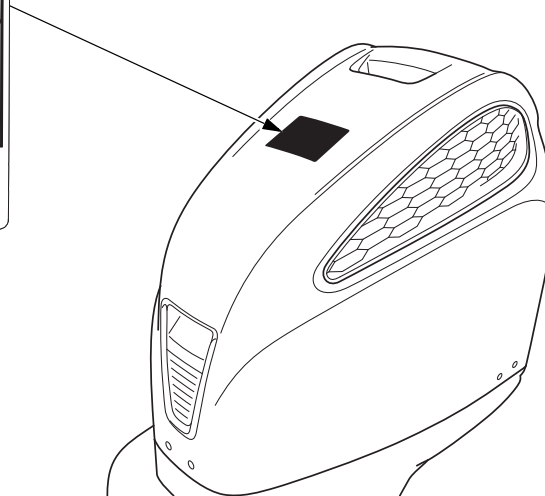
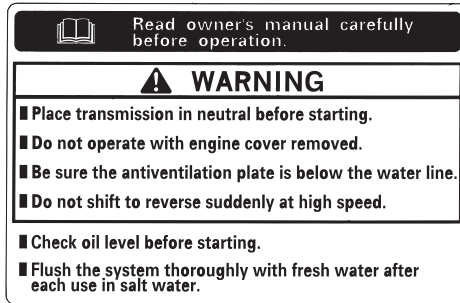

The label shown here contains important safety information. Please read it carefully. This label is considered a permanent part of your outboard motor. If the label comes off or becomes hard to read, contact an authorized TOHATSU dealer for a replacement.

CONTROLS AND FEATURES

CONTROL AND FEATURE IDENTIFICATION CODES

Model		BFT200D			BFT225D			BFT250D									
Type		LR□	XR□	XCR□	LR□	XR□	XCR□	LR□	LD□	XR□	XD□	UR□	UD□	XCR□	XCD□	UCR□	UCD□
Transom Height	20.0 in (508 mm)	•			•			•	•								
	25.0 in (635 mm)		•	•		•	•			•	•			•	•		
	30.0 in (762 mm)											•	•			•	•
Standard Rotating Propeller Shaft		•	•		•	•		•	•	•	•	•	•				
Counterrotating Propeller Shaft				•			•							•	•	•	•
Power Trim/Tilt		•	•	•	•	•	•	•	•	•	•	•	•	•	•	•	•
Mechanical wire		•	•	•	•	•	•	•		•		•		•		•	
Drive by Wire (DBW)									•		•		•		•		•

Refer to this chart for an explanation of the Type Codes used in this manual to identify control and feature applications.

TYPE CODE (example)

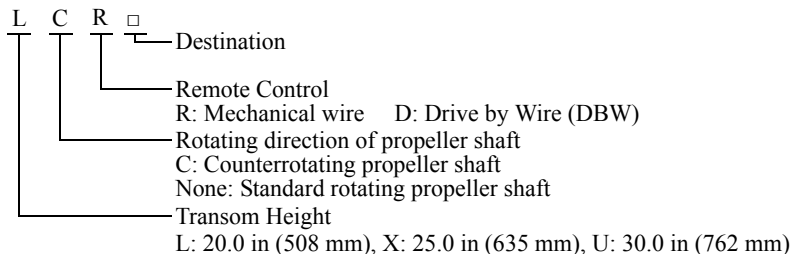

HOW TO DETERMINE WHICH DIRECTION THE PROPELLER SHAFT ROTATES

The direction the propeller shaft rotates can be determined based on whether or not the shaft has a groove.

With groove: Counterrotating

Without groove: Standard rotating

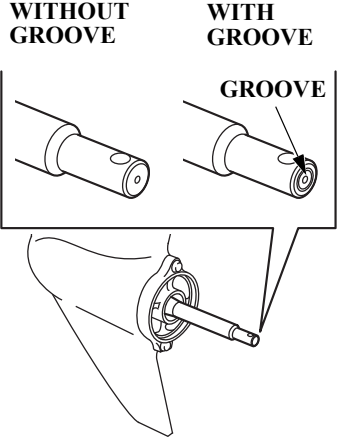

CONTROLS AND FEATURES

COMPONENT AND CONTROL LOCATIONS

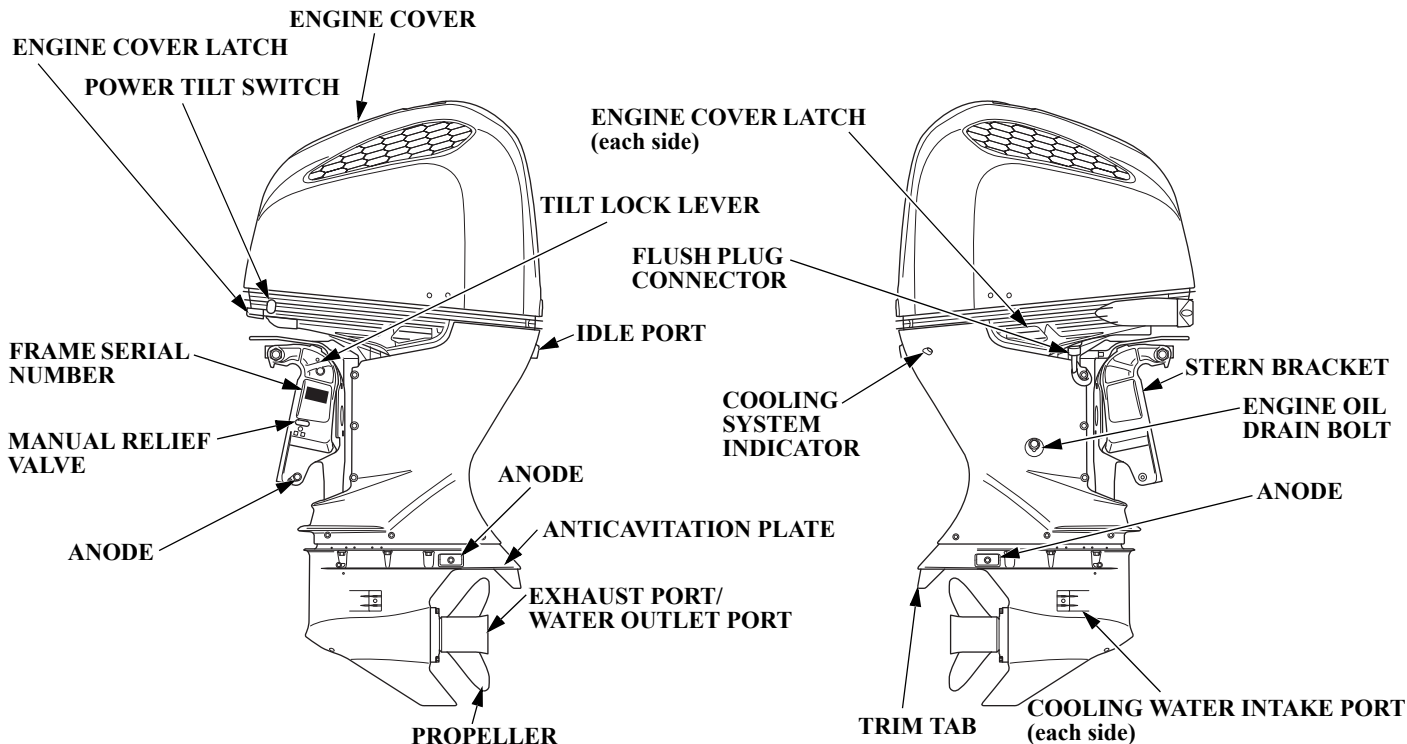

* Illustrations are based on X type

CONTROLS AND FEATURES

(Mechanical wire type)
THROTTLE ARM/SHIFT
ARM SHAFT

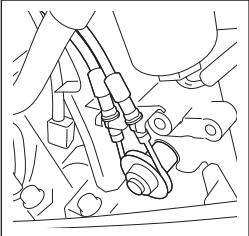

SPARK PLUGS
(under coil)

OIL LEVEL DIPSTICK

FUEL FILTER with
WATER SEPARATOR

CONTROLS AND FEATURES

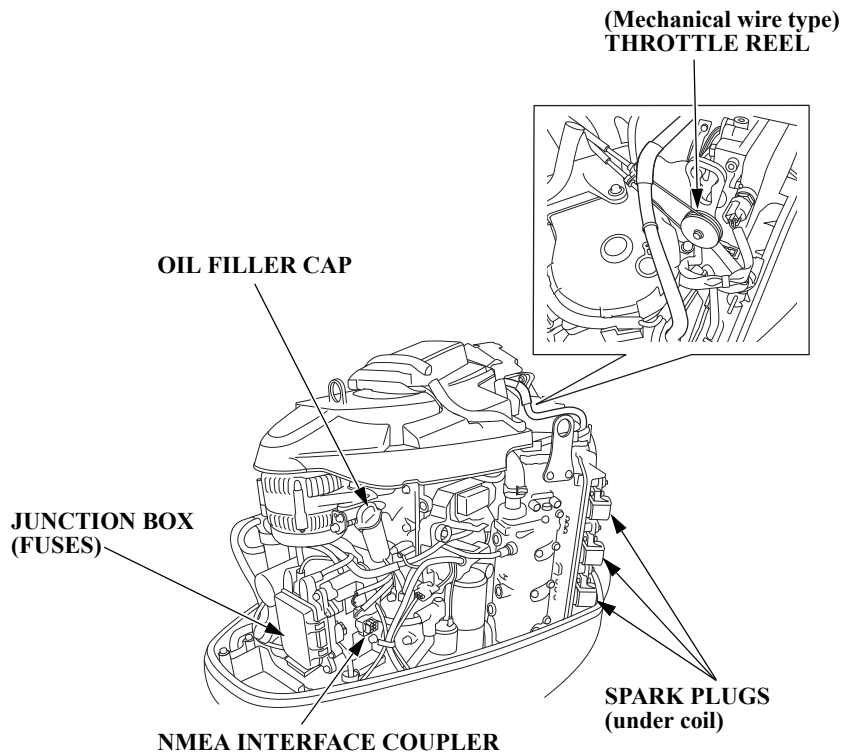

CONTROLS AND FEATURES

DBW Remote Control Box (optional equipment)

(FLUSH-MOUNT REMOTE CONTROL)

GEARSHIFT/
THROTTLE
CONTROL LEVER

POWER TRIM/TILT
SWITCH

NEUTRAL RELEASE
LEVER

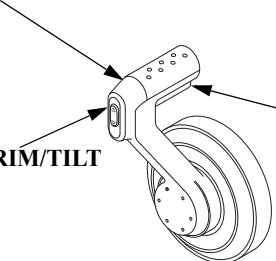

(SINGLE TOP-MOUNT REMOTE CONTROL)

GEARSHIFT/
THROTTLE
CONTROL LEVER

POWER TRIM/TILT
SWITCH

FUNCTION SWITCHES

(DUAL TOP-MOUNT REMOTE CONTROL)

GEARSHIFT/
THROTTLE
CONTROL LEVER

POWER TRIM/TILT
SWITCH

FUNCTION SWITCHES

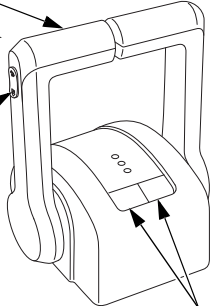
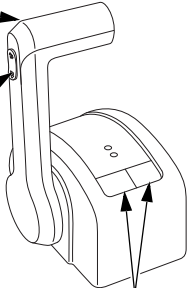

CONTROLS AND FEATURES

Key Switch Panel (optional equipment)

(With START/STOP switch type)
(Horizontal type)

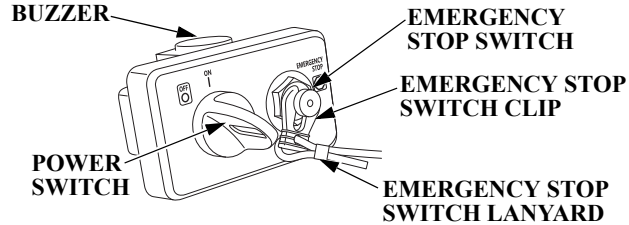

(Without START/STOP switch type)
(Horizontal type)

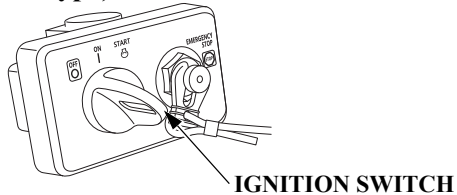

START/STOP Switch Panel (optional equipment)

START/STOP SWITCH

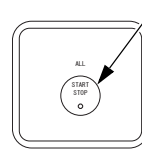

SINGLE TYPE/ALL
ENGINE START FOR
MULTIPLE
OUTBOARD MOTORS

START/STOP SWITCH

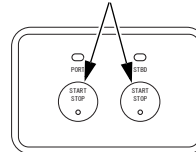

DUAL TYPE
OUTBOARD MOTOR

START/STOP SWITCH

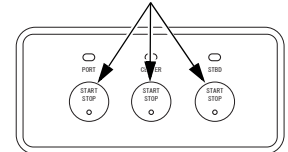

TRIPLE TYPE
OUTBOARD MOTOR

PORT: Port side engine
CENTER: Center engine
STBD: Starboard side engine

CONTROLS AND FEATURES

PTT Switch Panel (optional equipment)

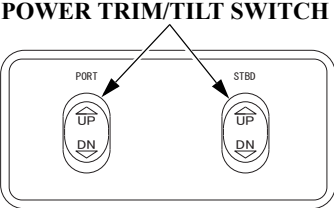

DUAL TYPE

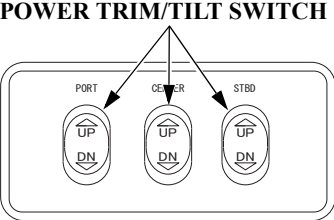

TRIPLE TYPE

PORT: Port side engine
CENTER: Center engine
STBD: Starboard side engine

Function Switch Panel (optional equipment) (for FLUSH-MOUNT type)

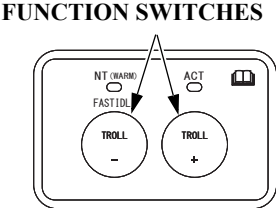

Emergency Stop Switch Panel (optional equipment)

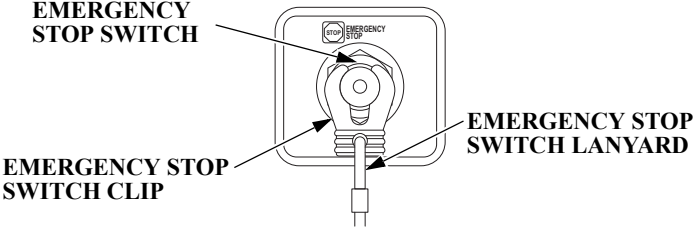

CONTROLS AND FEATURES

Remote Controls (optional equipment)

(SIDE-MOUNT REMOTE CONTROL)

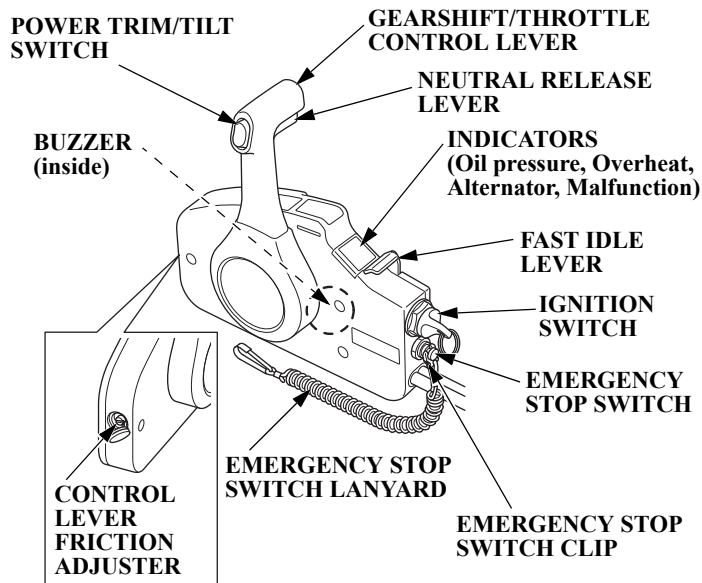

(FLUSH-MOUNT REMOTE CONTROL)

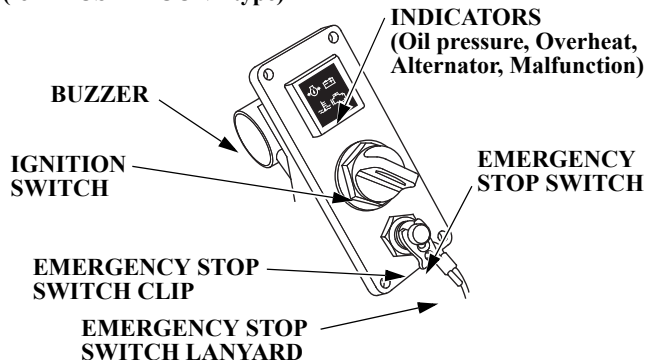
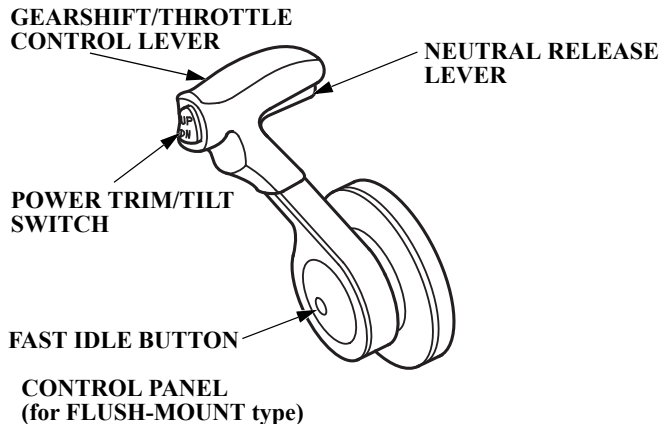

CONTROLS AND FEATURES

(SINGLE TOP-MOUNT REMOTE CONTROL)

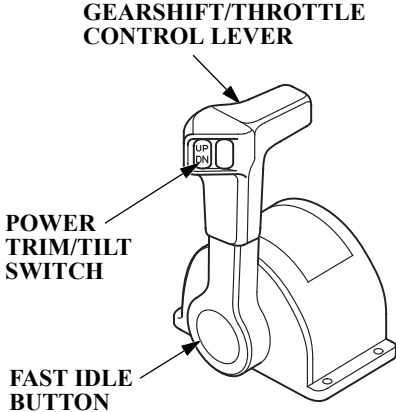

CONTROL PANEL
(for TOP-MOUNT SINGLE type)

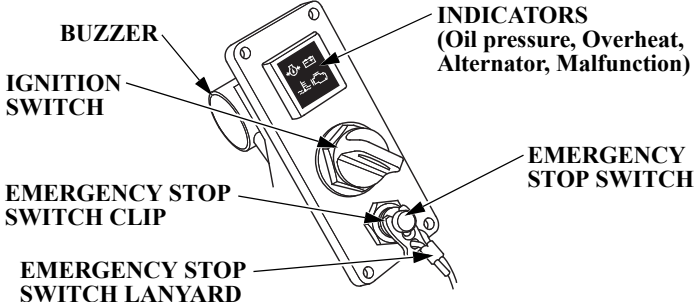

(DUAL TOP-MOUNT REMOTE CONTROL)

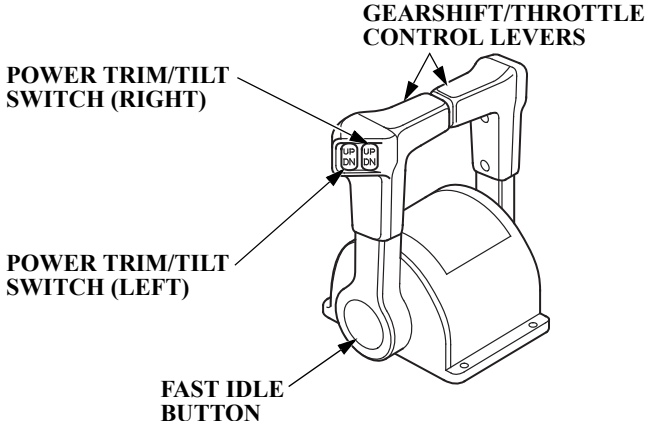

(for TOP-MOUNT DUAL type)

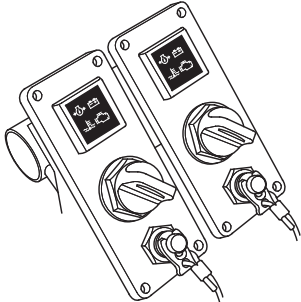

CONTROLS AND FEATURES

CONTROL PANEL without indicators type (optional equipment) (FLUSH-MOUNT, TOP-MOUNT SINGLE)

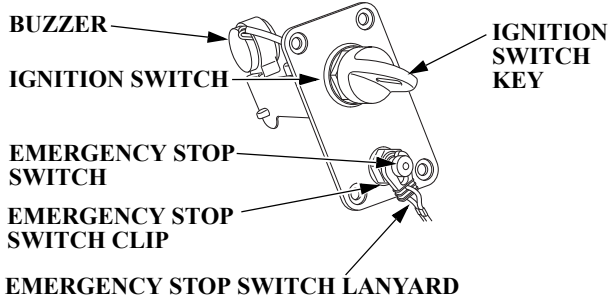

(for DUAL OUTBOARD MOTORS type)

(for TRIPLE OUTBOARD MOTORS type)

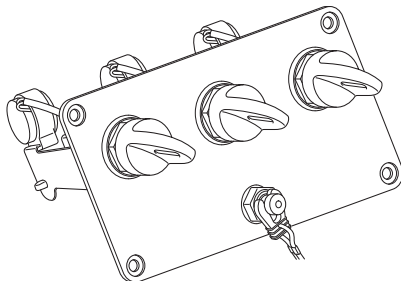
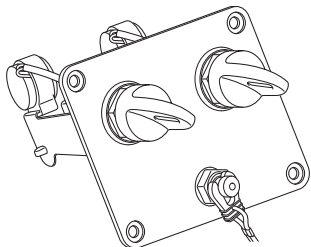

For the switch panel without indicators type, use it along with the NMEA2000-compatible device.

Tachometer (optional equipment)

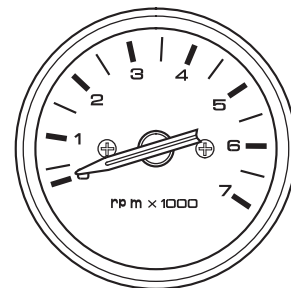

Trim Meter (optional equipment)

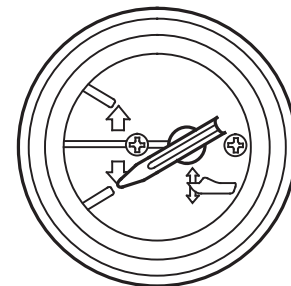

CONTROLS

Flush-Mount Type/Top-Mount Type (DBW type)

Ignition Switch (without START/STOP switch)

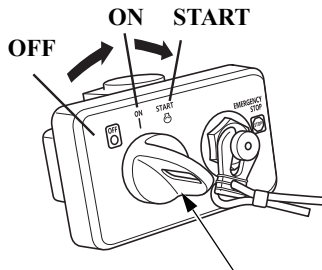

IGNITION SWITCH KEY

The ignition switch controls the ignition system and the starter motor.

Turning the ignition switch key to the START position starts the engine. The key automatically returns to the ON position when released from the START position.

The engine will not start unless the gearshift/throttle control lever is in the N (neutral) position (p. 56) and the emergency stop switch clip is in the emergency stop switch.

Turning the ignition switch to the OFF position stops the engine.

CONTROLS AND FEATURES

Power Switch ***(with START/STOP switch)***

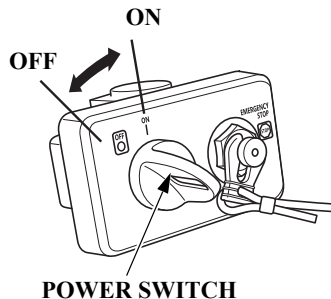

This remote control is equipped with the power switch. This switch locates on the key switch panel.

Key positions:

ON: to run the engine after starting.

OFF: to stop the engine
(IGNITION OFF).

NOTICE

Do not leave the power switch ON when the engine is not running as the battery will discharge.

The power will not be turned OFF if the engine is running.

START/STOP Switch

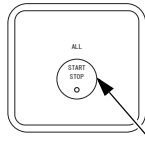

START/STOP SWITCH

**ALL ENGINE START
FOR MULTIPLE
OUTBOARD MOTORS**

Pushing the start/stop switch when the power is in ON starts the engine.

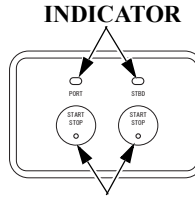

START/STOP SWITCH

**DUAL TYPE
OUTBOARD MOTORS**

For the multiple outboard motors, it is possible to start all engines at the same time by using the all engine start switch.

Also, it is possible to start each engine individually by using dual or triple type switch.

At this time, the indicator of the corresponding switch comes on.

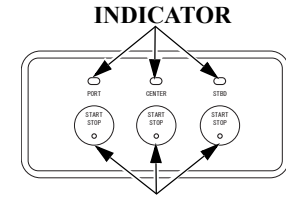

START/STOP SWITCH

**TRIPLE TYPE
OUTBOARD MOTORS**

The starter motor will not work unless the gearshift/throttle control lever is in the NEUTRAL position, and the clip is in the emergency stop switch.

CONTROLS AND FEATURES

Emergency Stop Switch Clip and Emergency Stop Switch

**EMERGENCY
STOP SWITCH**

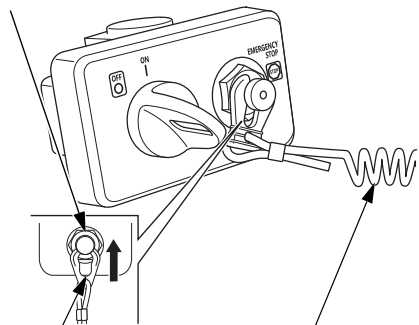

**EMERGENCY STOP
SWITCH CLIP**

**EMERGENCY
STOP SWITCH
LANYARD**

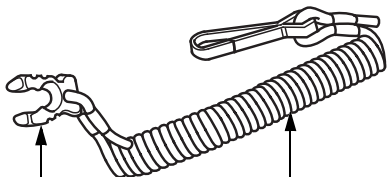

**EMERGENCY
STOP SWITCH
CLIP**

**EMERGENCY
STOP SWITCH
LANYARD**

The emergency stop switch clip must be inserted in the emergency stop switch in order for the engine to start and run. The emergency stop switch lanyard must be attached securely to the operator or to the operator's PFD (Personal Flotation Device).

When used as described, the emergency stop switch clip and emergency stop switch lanyard system stops the engine if the operator falls away from the controls.

A spare switch clip (optional equipment) can be stored in the tool bag.

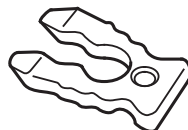

**SPARE SWITCH CLIP
(optional equipment)**

CONTROLS AND FEATURES

Gearshift/Throttle Control Lever (Flush-Mount type (DBW type))

GEARSHIFT/THROTTLE
CONTROL LEVER

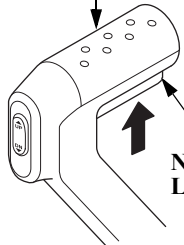

NEUTRAL RELEASE
LEVER

The gearshift/throttle control lever controls engine speed and selects F (forward), N (neutral), or R (reverse) gears.

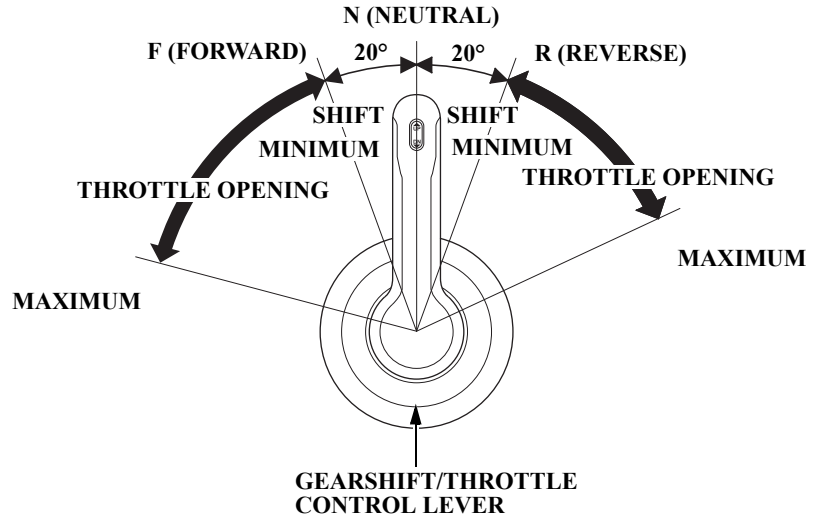

Moving the control lever 20° from N (neutral) selects the gear, and further movement increases engine speed.

The control lever automatically locks itself in the N (neutral) position. To move the lever out of the N (neutral) position, you must squeeze the neutral release lever on the underside of the lever handle.

A friction adjuster near the base of the control lever adjusts the operating resistance of the control lever. Refer to p. 73.

Less friction allows easier control lever movement. More friction helps to hold a steady throttle setting while cruising.

CONTROLS AND FEATURES

Gearshift/Throttle Control Lever (Top-Mount type (DBW type))

SINGLE TYPE

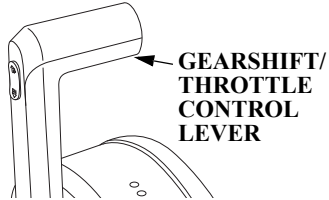

DUAL TYPE

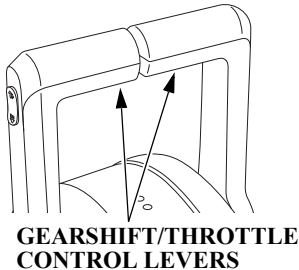

The gearshift/throttle control lever(s) controls engine speed and selects F (forward), N (neutral), or R (reverse) gears.

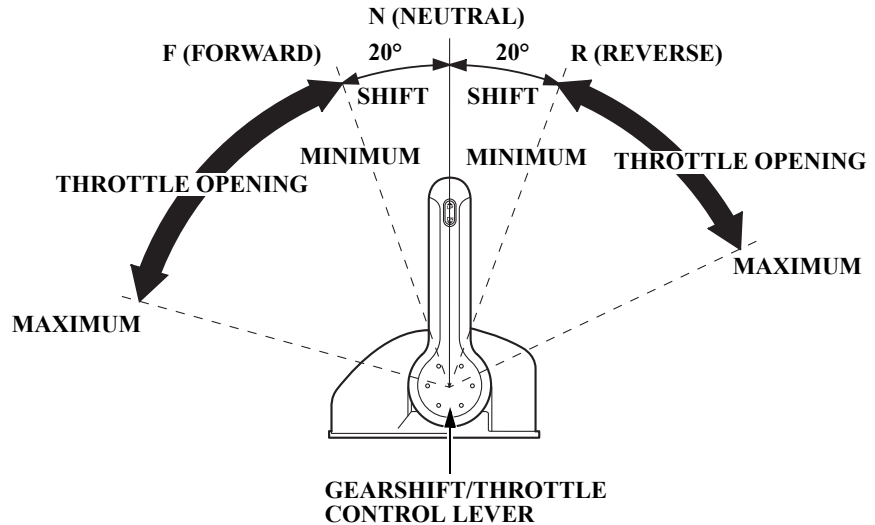

Moving the control lever 20° from N (neutral) selects the gear, and further movement increases engine speed.

A friction adjuster inside the control box adjusts the operating resistance of the control lever(s). Refer to p. 73.

Less friction allows easier control lever movement. More friction helps to hold a steady throttle setting while cruising.

Function Switches (Flush-Mount type)

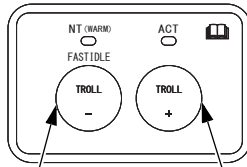

[-] SWITCH

[+] SWITCH

Function switches are used for operations in the fast idle mode and trolling mode.

NT (WARM)

Lights: The shift is in neutral.

Blinks: It is in the fast idle mode.

ACT

Lights: The shift and throttle operations are possible.

Off: The shift and throttle operations are not possible.

<Fast Idle Mode>

After the engine starts and if the outside temperature is below 41°F (5°C), the fast idle mode can be used to accelerate engine warm up.

See page 57 for engine warm-up instructions.

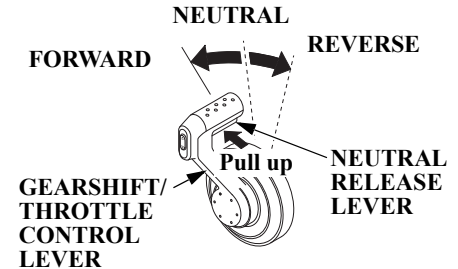

Use the [-] switch and the gearshift/throttle control lever to adjust the engine speed without gearshift when warming up the engine.

Keeping the [-] switch pressed when the gearshift/throttle control lever is in the NEUTRAL position, turn the lever forward. Keep turning the lever forward. The throttle opens and the engine speed increases after the lever passed the shift point.

Note that the gearshift mechanism does not function when the [-] switch is pushed once and then released after the gearshift/throttle control lever is moved.

The control lever does not operate unless the neutral release lever is pulled.

CONTROLS AND FEATURES

<Trolling Mode>

The engine speed can be adjusted with the [-] switch and [+] switch when in trolling mode.

If you press and hold the [+] switch while cruising with the throttle closed, the mode changes to trolling mode.

Function Switches (Single Top-Mount type (DBW type))

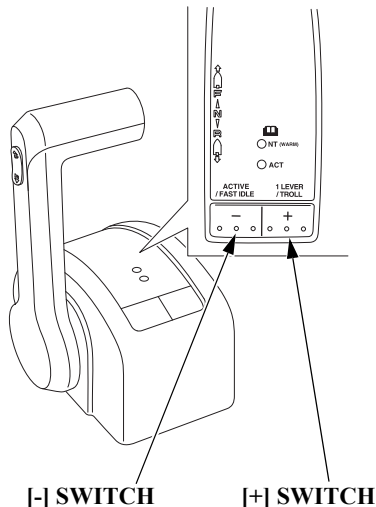

Function switches are used for operations in the fast idle mode, trolling mode, one-lever mode and station select mode.

NT (WARM)

Lights: The shift is in neutral.

Blinks: It is in the fast idle mode.

ACT

Lights: The shift and throttle operations are possible.

Off: The shift and throttle operations are not possible.

<Fast Idle Mode>

After the engine starts and if the outside temperature is below 41°F (5°C), the fast idle mode can be used to accelerate engine warm up.

See page 57 for engine warm-up instructions.

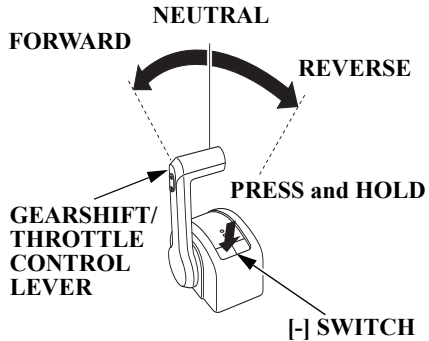

Use the [-] switch and the gearshift/throttle control lever to adjust the engine speed without gearshift when warming up the engine. Keeping the [-] switch pressed when the gearshift/throttle control lever is in the NEUTRAL position, turn the lever forward. Keep turning the lever forward. The throttle opens and the engine speed increases after the lever passed the shift point. Note that the gearshift mechanism does not function when the [-] switch is pushed once and then released after the gearshift/throttle control lever is moved.

<Trolling Mode>

The engine speed can be adjusted with the [-] switch and [+] switch when in trolling mode. If you press and hold the [+] switch while cruising with the throttle closed, the mode changes to trolling mode.

<One-Lever Mode>

(For multiple outboard motors type)
Shifting gear and the engine speed adjustment of the all outboard motors can be performed with one gearshift/throttle control lever when in one-lever mode. If you press and hold the [+] switch when all gearshift/throttle control lever is in the NEUTRAL position, the mode changes to one-lever mode.

<Station Select Mode>

For multiple station type, use the [-] switch to change the operating station. If you press and hold the [-] switch of the inactive station when all gearshift/throttle control lever is in the NEUTRAL position, you can operate the outboard motors using this station.

CONTROLS AND FEATURES

Side-Mount Type

Ignition Switch

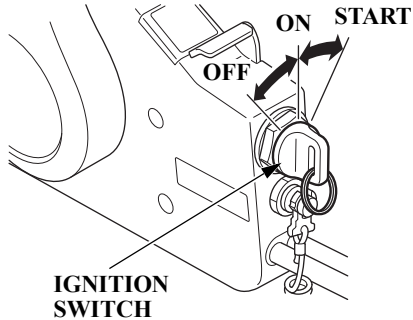

The ignition switch controls the ignition system and the starter motor.

Turning the ignition switch key to the START position starts the engine. The key automatically returns to the ON position when released from the START position.

The engine will not start unless the gearshift/throttle control lever is in the N (neutral) position (p. 59) and the emergency stop switch clip is in the emergency stop switch.

Turning the ignition switch to the OFF position stops the engine.

Emergency Stop Switch Clip and Emergency Stop Switch

**EMERGENCY
STOP SWITCH**

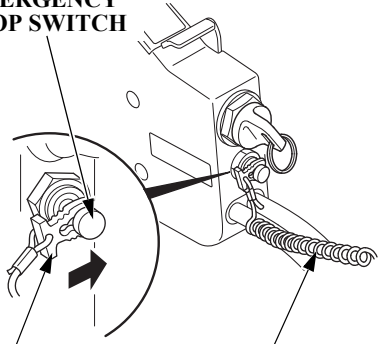

**EMERGENCY STOP
SWITCH CLIP**

**EMERGENCY STOP
SWITCH
LANYARD**

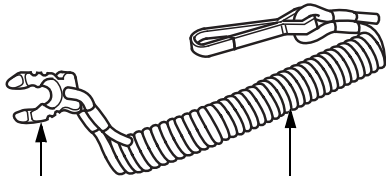

**EMERGENCY
STOP SWITCH
CLIP**

**EMERGENCY
STOP SWITCH
LANYARD**

The emergency stop switch clip must be inserted in the emergency stop switch in order for the engine to start and run. The emergency stop switch lanyard must be attached securely to the operator or to the operator's PFD (Personal Flotation Device).

When used as described, the emergency stop switch clip and emergency stop switch lanyard system stops the engine if the operator falls away from the controls.

A spare switch clip (optional equipment) can be stored in the tool bag.

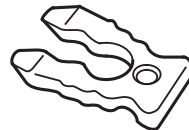

**SPARE SWITCH CLIP
(optional equipment)**

Gearshift/Throttle Control Lever

**GEARSHIFT/THROTTLE
CONTROL LEVER**

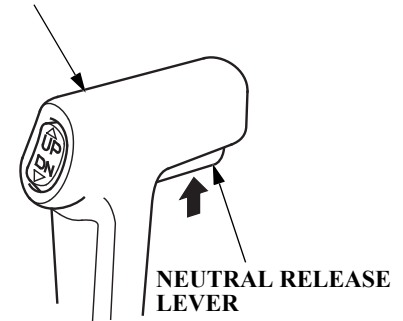

**NEUTRAL RELEASE
LEVER**

The gearshift/throttle control lever controls engine speed and selects F (forward), N (neutral), or R (reverse) gears.

CONTROLS AND FEATURES

Moving the control lever 32° from N (neutral) selects the gear, and further movement increases engine speed.

The control lever automatically locks itself in the N (neutral) position. To move the lever out of the N (neutral) position, you must squeeze the neutral release lever on the underside of the lever handle.

A friction adjuster adjusts the operating resistance of the control lever(s). Refer to p. 74.

Less friction allows easier control lever movement. More friction helps to hold a steady throttle setting while cruising.

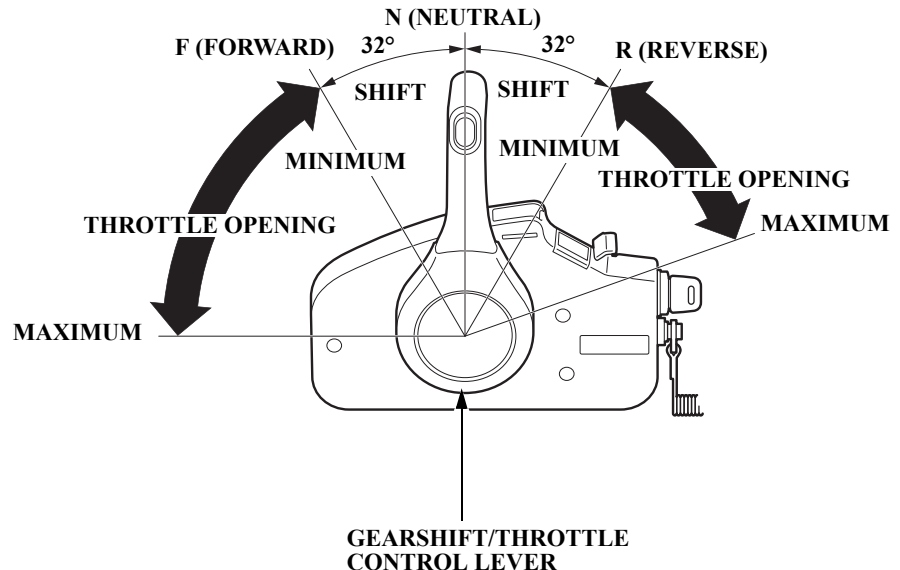

Fast Idle Lever

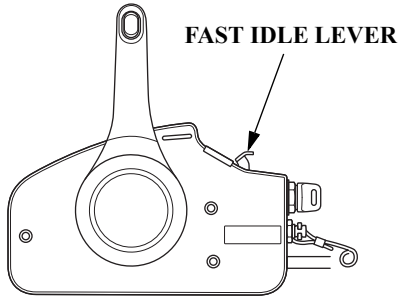

Use the fast idle lever to accelerate engine warm-up after starting the engine. Do not use the fast idle lever when starting the engine.

See page 61 for engine warm-up instructions.

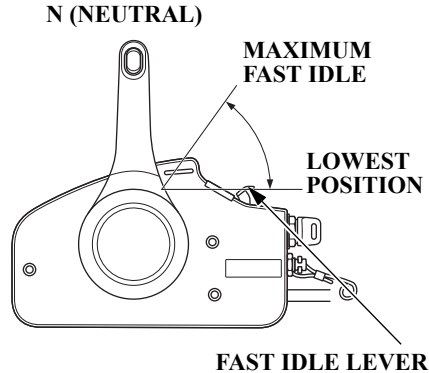

The fast idle lever allows you to increase the idle speed only when the control lever is in the N (neutral) position. Place the fast idle lever in its lowest position to cancel the fast idle and return the control lever to normal operation.

Flush-Mount Type (Mechanical wire type)

Ignition Switch

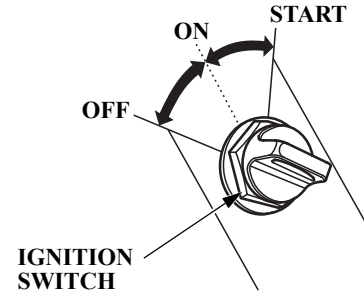

The ignition switch controls the ignition system and the starter motor.

CONTROLS AND FEATURES

Turning the ignition switch key to the START position starts the engine. The key automatically returns to the ON position when released from the START position.

The engine will not start unless the gearshift/throttle control lever is in the N (neutral) position (p. 62) and the emergency stop switch clip is in the emergency stop switch.

Turning the ignition switch to the OFF position stops the engine.

Emergency Stop Switch Clip and Emergency Stop Switch

**EMERGENCY
STOP SWITCH**

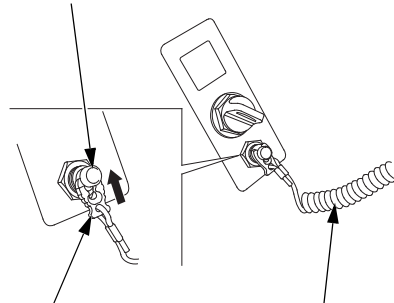

**EMERGENCY STOP
SWITCH CLIP**

**EMERGENCY
STOP SWITCH
LANYARD**

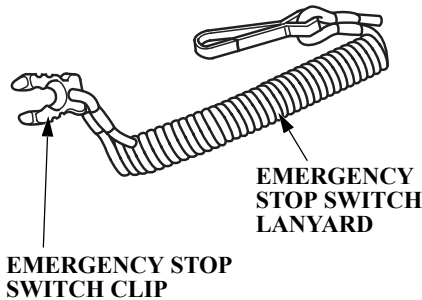

**EMERGENCY STOP
SWITCH CLIP**

**EMERGENCY
STOP SWITCH
LANYARD**

The emergency stop switch clip must be inserted in the emergency stop switch in order for the engine to start and run. The emergency stop switch lanyard must be attached securely to the operator or to the operator's PFD (Personal Flotation Device).

When used as described, the emergency stop switch clip and emergency stop switch lanyard system stops the engine if the operator falls away from the controls.

A spare switch clip (optional equipment) can be stored in the tool bag.

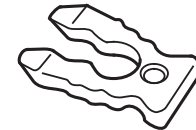

**SPARE SWITCH CLIP
(optional equipment)**

Gearshift/Throttle Control Lever

GEARSHIFT/THROTTLE CONTROL LEVER

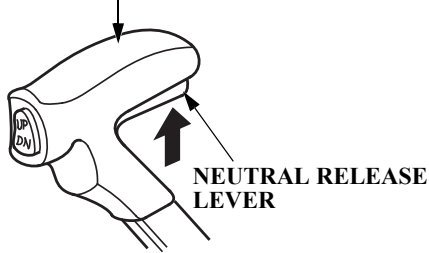

The gearshift/throttle control lever controls engine speed and selects F (forward), N (neutral), or R (reverse) gears.

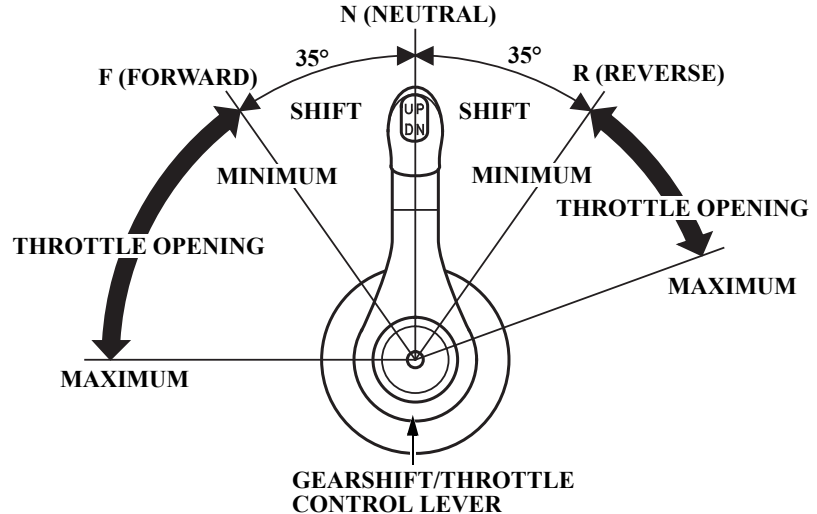

Moving the control lever 35° from N (neutral) selects the gear, and further movement increases engine speed.

The control lever automatically locks itself in the N (neutral) position. To move the lever out of the N (neutral) position, you must squeeze the neutral release lever on the underside of the lever handle.

A friction adjuster near the base of the control lever adjusts the operating resistance of the control lever. Refer to p. 74.

Less friction allows easier control lever movement. More friction helps to hold a steady throttle setting while cruising.

CONTROLS AND FEATURES

Fast Idle Button

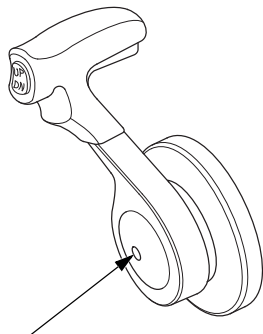

FAST IDLE BUTTON

Use the fast idle button to accelerate engine warm-up after starting the engine. Do not use the fast idle button when starting the engine.

See page 63 for engine warm-up instructions.

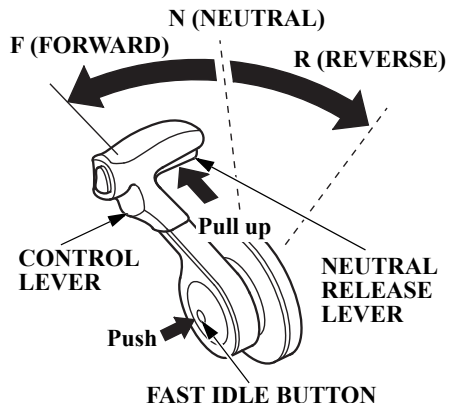

FAST IDLE BUTTON

The fast idle button allows you to increase the idle speed without engaging the drive gears. Move the control lever forward or reverse after pushing in the fast idle button to increase the idle speed.

It is necessary to position the control lever in the N (neutral) position to push in the fast idle button.

Return the control lever to N (neutral) position to cancel the fast idle operation.

Top-Mount Type (Mechanical wire type)

Ignition Switch

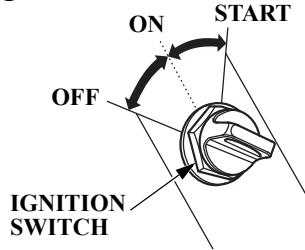

The ignition switch controls the ignition system and the starter motor.

Turning the ignition switch key to the START position starts the engine. The key automatically returns to the ON position when released from the START position.

The engine will not start unless the gearshift/throttle control lever is in the N (neutral) position (p. 65) and the emergency stop switch clip is in the emergency stop switch.

Turning the ignition switch to the OFF position stops the engine.

Emergency Stop Switch Clip and Emergency Stop Switch

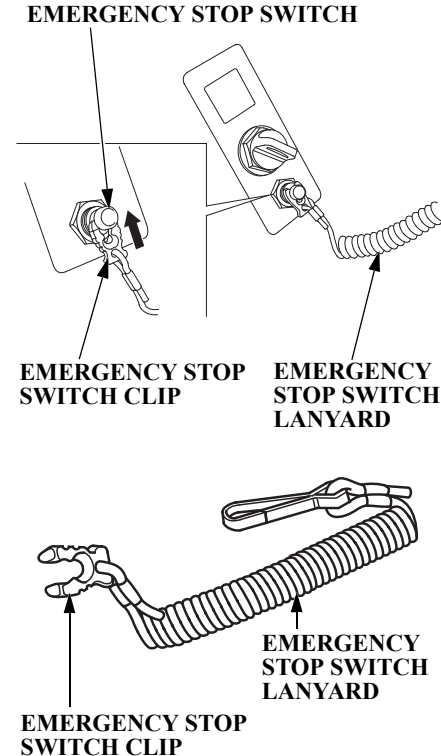

The emergency stop switch clip must be inserted in the emergency stop switch in order for the engine to start and run. The emergency stop switch lanyard must be attached securely to the operator or to the operator's PFD (Personal Flotation Device).

When used as described, the emergency stop switch clip and emergency stop switch lanyard system stops the engine if the operator falls away from the controls.

A spare switch clip (optional equipment) can be stored in the tool bag.

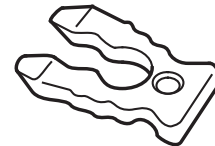

SPARE SWITCH CLIP
(optional equipment)

CONTROLS AND FEATURES

Gearshift/Throttle Control Lever

SINGLE TYPE

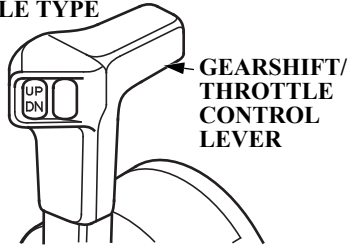

DUAL TYPE

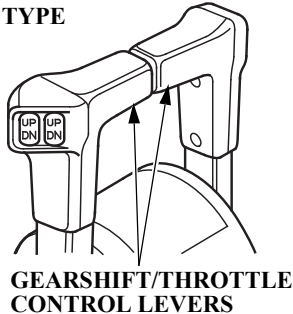

The gearshift/throttle control lever(s) controls engine speed and selects F (forward), N (neutral), or R (reverse) gears.

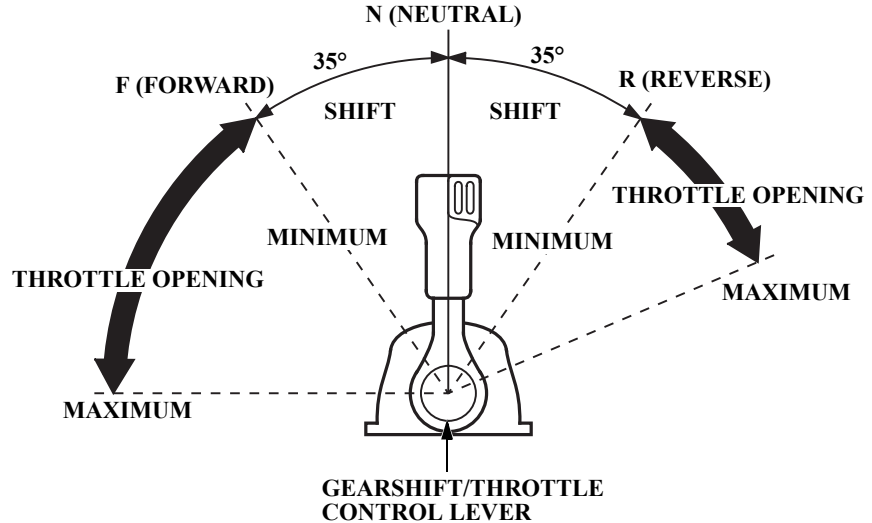

Moving the control lever 35° from N (neutral) selects the gear, and further movement increases engine speed.

A friction adjuster inside the control box adjusts the operating resistance of the control lever(s). Refer to p. 74.

Less friction allows easier control lever movement. More friction helps to hold a steady throttle setting while cruising.

Fast Idle Button

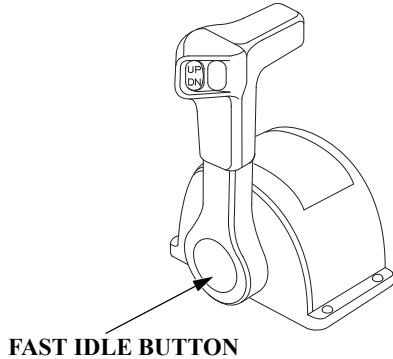

Use the fast idle button to accelerate engine warm-up after starting the engine. Do not use the fast idle button when starting the engine.

See page 66 for engine warm-up instructions.

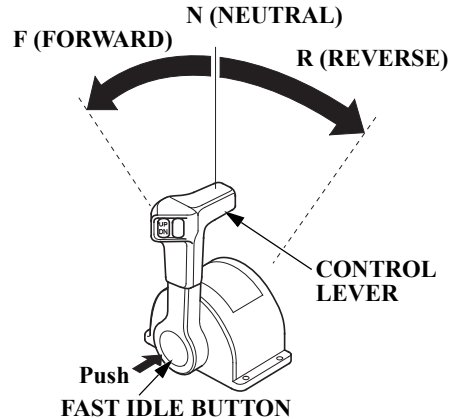

The fast idle button allows you to increase the idle speed without engaging the drive gears. Move the control lever forward or reverse after pushing in the fast idle button to increase the idle speed.

It is necessary to position the control lever in the N (neutral) position to push in the fast idle button.

Return the control lever to N (neutral) position to cancel the fast idle operation.

CONTROLS AND FEATURES

Common Controls

Power Trim/Tilt Switch

(flush-mount type)

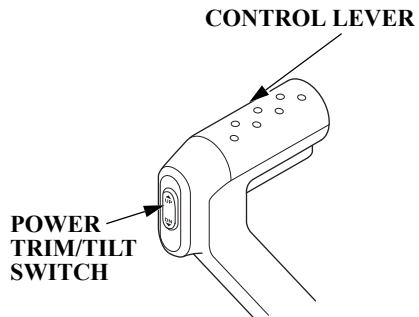

(top-mount type
(drive by wire type))

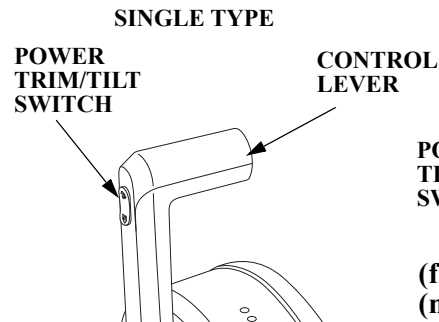

(side-mount type)

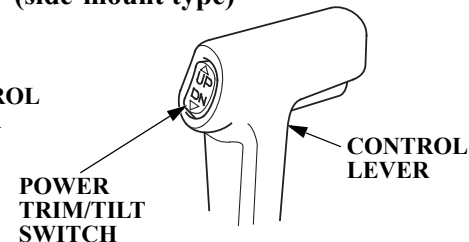

(flush-mount type
(mechanical wire type))

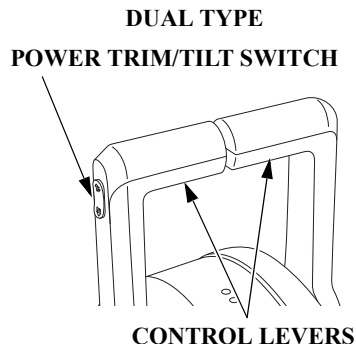
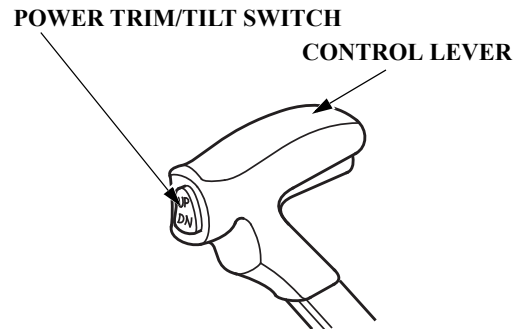

CONTROLS AND FEATURES

**(top-mount type
(mechanical wire type))**

**SINGLE TYPE
POWER TRIM/TILT SWITCH**

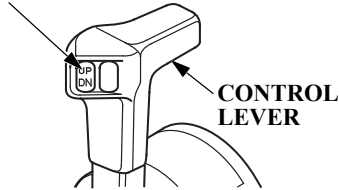

**DUAL TYPE
POWER TRIM/TILT SWITCH
(LEFT) (RIGHT)**

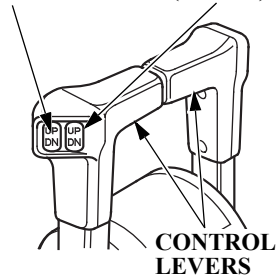

The power trim/tilt switch is located on the control lever. It is a rocker switch with UP and DN (down) positions for changing the angle of the outboard motor.

You can use the power trim/tilt switch anytime whether the boat is underway, stopped, or the ignition switch is in the OFF position. It is necessary for the ignition switch to be in the ON position for the trim meter to indicate the outboard motor angle. Trim the outboard motor to obtain the best performance and stability (p. 75).

Tilt the outboard motor for shallow water operation, beaching, launching, or mooring.

For dual mount outboard motors, tilt them up at the same time.

CONTROLS AND FEATURES

PTT Switch Panel

POWER TRIM/TILT SWITCH PANEL

DUAL TYPE

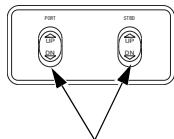

TRIPLE TYPE

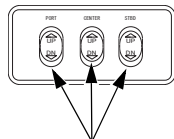

POWER TRIM/TILT SWITCH

For multiple outboard motors, the trim/tilt angle of all outboard motors is adjusted at the same time by using the power trim/tilt switch on the remote control lever and the trim/tilt angle of each outboard motor is adjusted by using each power trim/tilt switch on the panel.

Power Tilt Switch

POWER TILT SWITCH

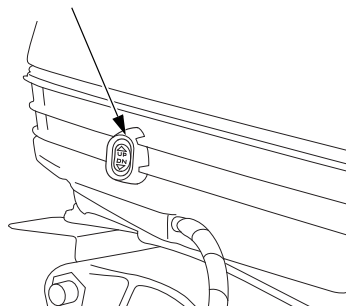

The power tilt switch is located on the engine pan. It is a rocker switch with UP and DN (down) positions for changing the angle of the outboard motor.

The power tilt switch will operate without turning the ignition switch ON.

This switch is used with the engine stopped to raise the outboard motor for mooring, trailering, or maintenance.

Manual Relief Valve

MANUAL RELIEF VALVE

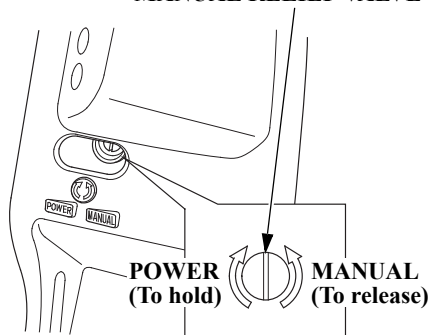

The outboard motor can be tilted manually after opening the manual relief valve. This allows the outboard motor to be tilted up or down when no battery is connected.

Tilt Lock Lever

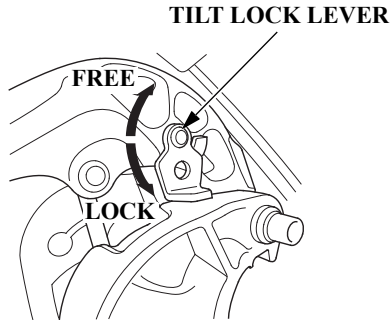

The tilt lock lever is used to support the outboard motor in the fully-raised position.

When the boat is to be moored for a long time, tilt the outboard motor up as far as it will go. Then move the tilt lock lever to the LOCK position, and gently lower the outboard motor until the lever contacts the stern bracket.

Engine Cover Latch

Front

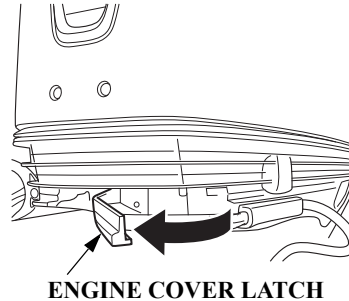

Side

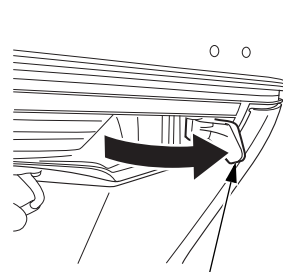

ENGINE COVER LATCH (each side)

The engine cover latch fastens the engine cover to the outboard motor.

Trim Tab

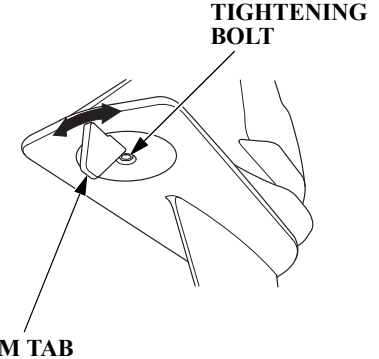

The trim tab compensates for “torque steer,” which is a reaction of the outboard motor to propeller rotation.

If uncompensated, torque steer would make the outboard motor tend to turn to one side.

When the trim tab is correctly adjusted (p. 87), steering effort is equal in either direction.

CONTROLS AND FEATURES

INSTRUMENTS

Trim Meter (optional equipment)

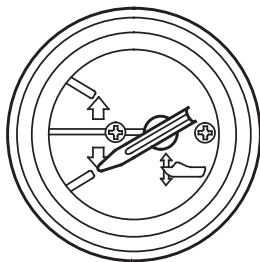

TRIM METER

The trim meter indicates the relative trim angle of the outboard motor.

Refer to the trim meter when using the power trim/tilt switch to achieve the best performance from the boat.

Tachometer (optional equipment)

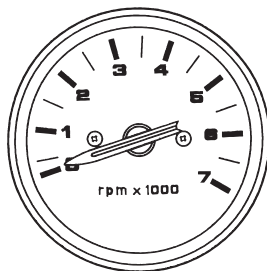

TACHOMETER

The tachometer shows engine speed in revolutions per minute.

Refer to the tachometer when using the throttle and power trim/tilt controls to achieve the best performance from the boat.

NMEA Interface Coupler

The NMEA2000[®] interface coupler can provide information regarding engine speed, fuel consumption, and various warnings to an existing NMEA2000 network via an optional interface cable. Contact your dealer for more information.

NMEA INTERFACE COUPLER

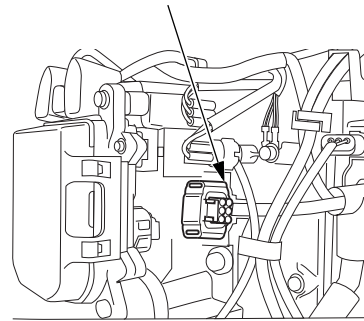

Operating Hour Notification System

This outboard motor engine counts the number of operating hours since the last periodic maintenance. When the next periodic maintenance is due, the engine notifies the NMEA2000 network, and a maintenance indication is displayed on an NMEA2000-compatible device.

After periodic maintenance is performed, reset the hour counter by:

DBW type:

1. Turn ON the power switch or engine switch. (The buzzer will sound twice.)
 - Wait at least 1 second.
2. With the control lever of the outboard motor, shift to the "F" (forward) or "R" (reverse) gear.
3. Turn OFF the power switch or engine switch.

4. Turn ON the power switch or engine switch. (The buzzer will sound twice.)
5. Insert and remove the emergency stop switch clip five times within 20 seconds.
 - When reset, the buzzer will sound once.

Mechanical wire type:

1. Stop the engine.
2. Set the gearshift at F or R.
3. Turn the ignition switch ON.
The buzzer will sound once.
4. Insert and remove the emergency stop switch clip five times within 20 seconds.
The buzzer will sound once when the hour counter is reset.

Periodic maintenance is required when either the operating hours or the time since last maintenance reaches the prescribed limit. Therefore, periodic maintenance may be required based on the number of months since the last maintenance before the alert based on engine operating hours displays (see *MAINTENANCE SCHEDULE* on page 85).
Reset the hour counter whenever maintenance is performed, whether based on the time interval or the number of operating hours.

CONTROLS AND FEATURES

<Operating hour notification timing>

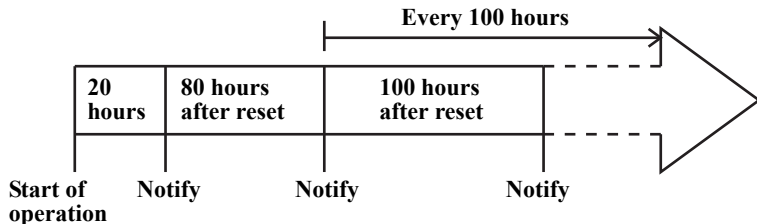

<Display>

Steps	1	2	3	4
Outboard motor	—	Ignition switch ON	Start engine	Gear at F or R
Display	Switch ON	—	—	—
Maintenance indication on display	Not shown Maintenance indication	Shown Maintenance indication	Shown Maintenance indication	Not shown Maintenance indication

- NMEA2000-compatible display:
- Follow instructions for the display.
 - If the display allows selection of notification to be preset, select "Notify" (or equivalent).
 - Turn on the power supply to the display before turning on the ignition switch of the outboard motor.
 - The indication may differ, depending on the type of display.

When "Periodic Maintenance" is indicated:

1. Have the periodic maintenance performed without delay after returning to port.
2. Reset the hour counter.

If not reset, the maintenance indication will remain in the display, and the hour count until the next maintenance will be in error.

When the periodic maintenance is conducted before "Periodic Maintenance" is indicated, reset the hour counter.

If not reset, the hour count until the next maintenance will be in error.

INDICATORS

The indicator lights come on and the buzzer sounds when you turn the ignition switch ON, allowing you to see that they are working. If an indicator does not light during this test, it cannot alert you if that system develops a problem. Have your TOHATSU dealer check for burned-out bulbs or other problems. Under normal conditions, the following occur when the ignition switch is turned ON:

1. The ACG, Malfunction, Oil Pressure, and Overheat indicators light.
2. The buzzer will beep twice.
3. The Malfunction, Oil Pressure, and Overheat indicators will go out after the second beep.
4. The ACG indicator will go out after the engine starts.
5. The Oil Pressure indicator will light again after the engine starts and will stay lit to indicate the oil pressure is normal.

Alternator (ACG) Indicator

(side-mount type)

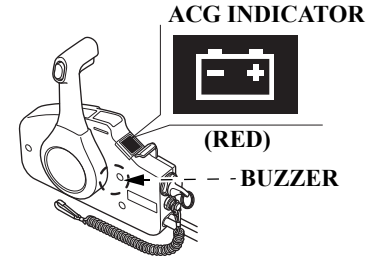

(flush-mount, top-mount type
(mechanical wire type))

ACG INDICATOR

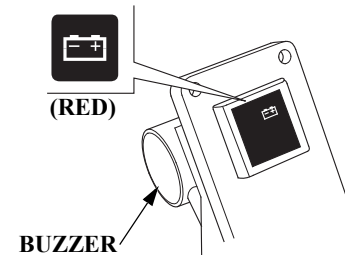

The ACG indicator turns on and the buzzer sounds in one-second intervals when the charging system is faulty.

CONTROLS AND FEATURES

Malfunction Indicator

(side-mount type)

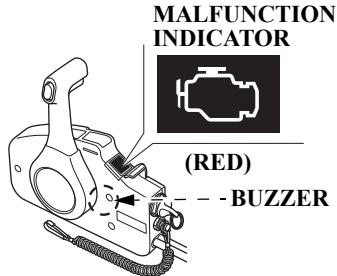

(flush-mount, top-mount type
(mechanical wire type))

MALFUNCTION INDICATOR

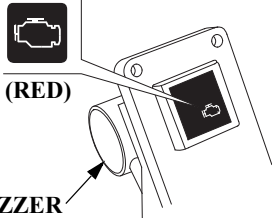

When the engine control system detects an engine control system malfunction, the malfunction indicator turns on and the buzzer sounds at one-second intervals.

Oil Pressure Indicator

(side-mount type)

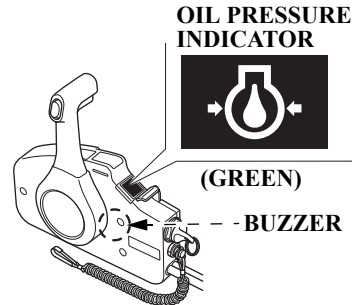

(flush-mount, top-mount type
(mechanical wire type))

OIL PRESSURE INDICATOR

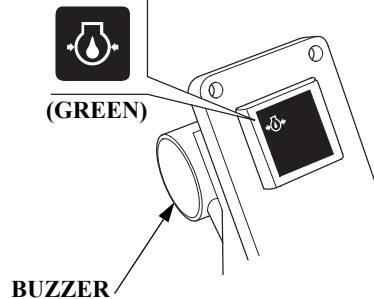

When the oil pressure indicator is lit, oil pressure is OK.

If oil pressure becomes low, the indicator will turn off, and the engine protection system will limit engine speed. Refer to *TAKING CARE OF UNEXPECTED PROBLEMS*, on p. 123.

All models are equipped with a buzzer that sounds continuously when the oil pressure indicator turns off.

Low oil pressure indicates that the engine oil level is low or that there is a problem with the engine lubrication system.

Overheat Indicator

(side-mount type)

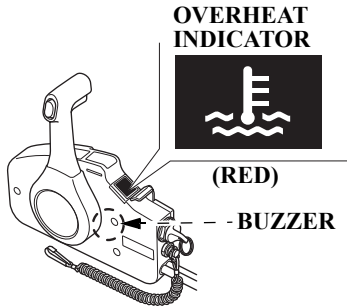

(flush-mount, top-mount type
(mechanical wire type))

OVERHEAT INDICATOR

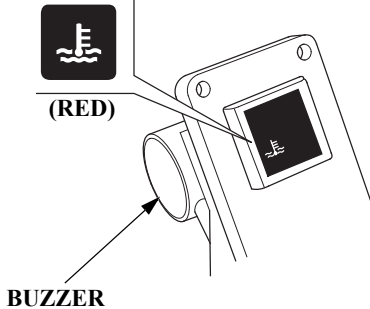

When the alert triggers, the overheat indicator comes on and the buzzer sounds a steady tone as the engine speed is reduced to 1,800 rpm. If the condition persists for another 20 seconds, the engine shuts off. Refer to *TAKING CARE OF UNEXPECTED PROBLEMS*, on p. 124.

All models are equipped with a buzzer that sounds continuously when the red overheat indicator light comes on.

Engine overheating may be the result of clogged water intakes.

Cooling System Indicator

COOLING SYSTEM INDICATOR

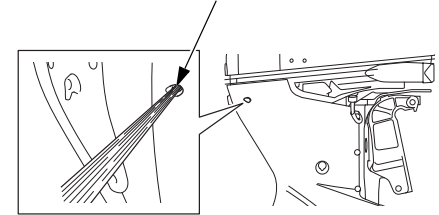

Water should flow from the cooling system indicator while the engine is running. This shows that water is circulating through the cooling system.

If water stops flowing while the engine is running, it indicates a cooling system problem, such as clogged water intakes, which will cause engine overheating.

CONTROLS AND FEATURES

OTHER FEATURES

Water Separator Buzzer

The water separator buzzer sounds a rapid, repeating signal when water has accumulated in the water separator.

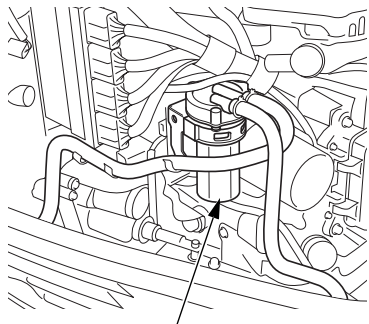

WATER SEPARATOR

Rev Limiter

The engine is equipped with a rev limiter to prevent the possibility of mechanical damage from excessive engine speed.

The rev limiter may be activated during operation, limiting engine speed, if the outboard motor is trimmed or tilted up excessively, or when propeller ventilation occurs during a sharp turn.

If the rev limiter is activated, check the trim angle of the outboard motor.

Check to see if the correct propeller is installed.

Anodes

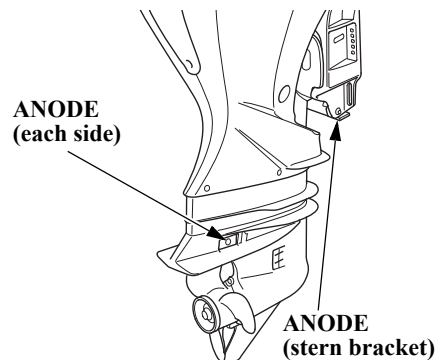

The anodes are made of a sacrificial material that helps to protect the outboard motor from corrosion.

There are two anodes on the gear case, one on the stern bracket and four small anodes in the water passages of the engine block.

Fuel Priming Bulb

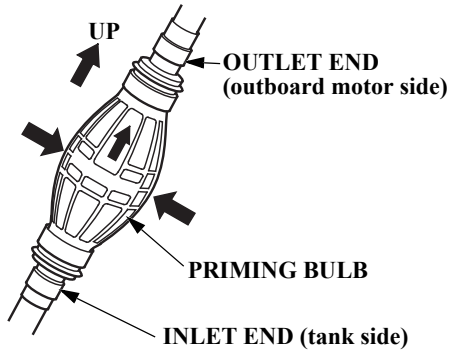

A priming bulb is built into the fuel hose that connects the fuel tank to the outboard motor.

Before starting the engine, hold the priming bulb up in the direction of the arrow; then squeeze the priming bulb until it feels firm. This will ensure that fuel is supplied to the engine (p. 55).

BEFORE OPERATION

ARE YOU READY TO GET UNDERWAY?

Your safety is your responsibility. A little time spent in preparation will significantly reduce your risk of injury.

Knowledge

Read and understand this manual. Know what the controls do and how to operate them.

Familiarize yourself with the outboard motor and its operation before you get underway. Know what to do in case of an emergency.

Familiarize yourself with all laws and regulations relating to boating and the use of outboard motors.

Safety

Always wear a PFD (Personal Flotation Device) while on the boat.

Attach the emergency stop switch lanyard securely to the operator or to the PFD worn by the operator.

IS YOUR OUTBOARD MOTOR READY TO GO?

For your safety, and to maximize the service life of your equipment, it is very important to take a few moments before you operate the outboard motor to check its condition.

Be sure to take care of any problem you find, or have your authorized TOHATSU dealer correct it, before you operate the outboard motor.

WARNING

Failure to properly maintain this outboard motor, or failing to correct a problem before operation, could result in a significant malfunction.

Some malfunctions can cause serious injuries or death.

Always perform a pre-operation inspection before each operation and correct any problems.

(Without START/STOP Switch Type)

Before beginning your pre-operation checks, be sure the IGNITION switch key is in the OFF position.

(With START/STOP Switch Type)

Before beginning your pre-operation checks, be sure the power switch is in the OFF position.

Safety Inspection

- Before each use, look around and underneath the engine for signs of oil or gasoline leaks.
- Check that the fuel hose is undamaged and properly connected.
- Wipe up any spills before starting the engine.
- Check the stern bracket to be sure the outboard motor is securely installed.
- Check that all controls are operating properly.
- Replace any damaged parts.
- Check that all fasteners are in place and securely tightened.

- Check the emergency stop switch for proper operation. Start the engine (p. 24, 31, 34 or 37). Make sure the engine stops by pulling the emergency stop switch clip from the emergency stop switch.

Maintenance Inspection

- Check the engine oil level (p. 89). Running the engine with a low oil level can cause engine damage. Overfilling the engine can cause the engine to smoke or have oil leaks which can cause engine damage.
- Check to be sure the propeller is undamaged and the castle nut is secured with the cotter pin (p. 105).
- Check that the anodes are securely attached to the stern bracket and the gear case (p. 104) and are not excessively worn. The anodes help protect the outboard motor from corrosion.

- Make sure the tool kit is onboard (p. 84). Replace any missing items.
- Check the fuel level in the fuel tank (p. 99).
- Check that the battery fluid is between the upper and lower levels, and the battery leads are connected securely.
- Check the fuel filter for water or sediment accumulated (p. 101).

OPERATION

SAFE OPERATING PRECAUTIONS

WARNING

Exhaust contains poisonous carbon monoxide gas that can build up to dangerous levels in closed areas.

Breathing carbon monoxide can cause unconsciousness or death.

Never run this product's engine in a closed, or even partly closed area.

To safely realize the full potential of this outboard motor, you need a complete understanding of its operation and a certain amount of practice with its controls.

Before operating the outboard motor for the first time, please review the *IMPORTANT SAFETY INFORMATION* on page 7 and the chapter titled *BEFORE OPERATION*.

For your safety, do not start or run the engine in a confined or partly enclosed area. Your engine's exhaust contains poisonous carbon monoxide, a colorless, odorless gas that can collect rapidly. Breathing carbon monoxide can cause loss of consciousness and may lead to death.

BREAK-IN PROCEDURE

Break-in period: 10 hours

Proper break-in operation allows the moving parts to wear in smoothly for best performance and long service life. Avoid continuous operation at a steady speed.

First 15 minutes:

Run the engine at trolling speed. Use the minimum throttle opening necessary to operate the boat at a safe trolling speed.

Next 45 minutes:

Run the engine up to a maximum of 2,000 to 3,000 rpm, which is about 10% to 30% of maximum throttle opening. Operating at maximum 2,000 ~ 3,000 rpm should be limited to 50% of the 45 minutes.

Next 60 minutes:

Run the engine up to a maximum of 4,000 to 5,000 rpm, which is about 50% to 80% of maximum throttle opening. Operating at maximum 4,000 ~ 5,000 rpm should be limited to 50% of the 60 minutes. 30-second full-throttle bursts are OK, but do not operate the engine continuously at full throttle.

For boats that plane easily, bring the boat up on plane, and then reduce the throttle opening to the recommended rpm range.

Next 8 hours:

Do not run the engine at full throttle for more than 5 minutes at a time.

FUEL PRIMING

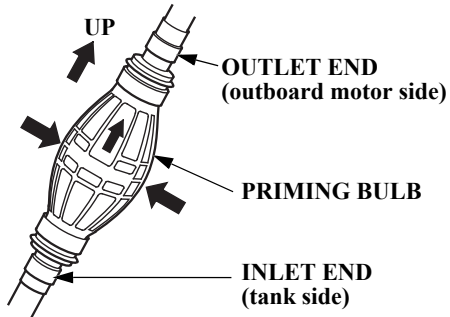

Hold the priming bulb up in the direction of the arrow; then squeeze the priming bulb several times until it feels firm, indicating that fuel has reached the engine.

Check to be sure there are no fuel leaks before starting the engine.

Do not touch the priming bulb with the engine running or when tilting up the outboard motor. The vapor separator could overflow.

⚠ WARNING

Gasoline is highly flammable and explosive.

You can be burned or seriously injured when handling fuel.

- Stop the engine and let it cool before handling fuel.
- Keep heat, sparks, and flame away.
- Handle fuel only outdoors.
- Keep away from your vehicle.
- Wipe up spills immediately.

INFREQUENT OR OCCASIONAL USE

If your outboard motor will be used on an infrequent or intermittent basis, please refer to the fuel section of the *STORAGE* chapter (p. 109) for additional information regarding fuel deterioration.

OPERATION

STARTING THE ENGINE

Control

- Flush-Mount Type/
Top-Mount Type (DBW type) ... P. 56
- Side-Mount Type P. 59
- Flush-mount type
(Mechanical wire type)..... P. 62
- Top-Mount Type
(Mechanical wire type)..... P. 64

Flush-Mount Type/Top-Mount Type (DBW type)

EMERGENCY STOP SWITCH

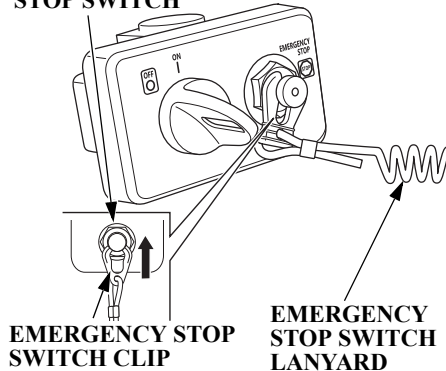

1. Put the emergency stop switch clip in the emergency stop switch, and attach the emergency stop switch lanyard securely to the operator or to the operator's PFD (Personal Flotation Device).

The engine will not start or run unless the emergency stop switch clip is in the emergency stop switch.

The emergency stop switch clip and emergency stop switch lanyard system is a safety device that will stop the engine if you fall away from the controls while operating the boat.

Always attach the emergency stop switch lanyard securely to the operator or to the operator's PFD before starting the engine.

Flush-Mount Type (DBW type)

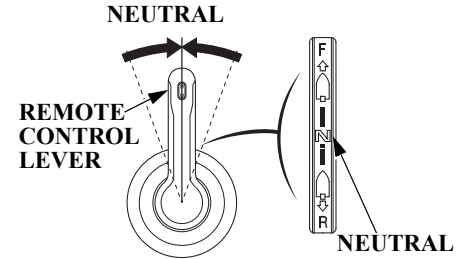

Top-Mount Type (DBW type)

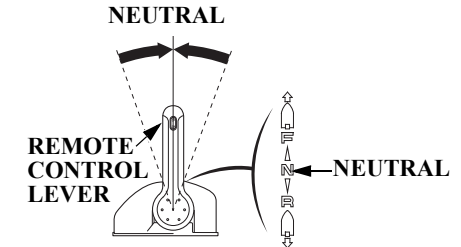

2. Set the control lever in the N (neutral) position.

The engine will not start if the F (forward) or R (reverse) gears are engaged.

(Without START/STOP Switch Type)

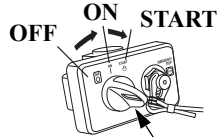

IGNITION SWITCH KEY

3. Turn the IGNITION switch key to the START position and hold it there until the engine starts. When the engine starts, release the key, allowing it to return to the ON position.
Go to step 5.

NOTICE

- Do not turn the IGNITION switch key to the START position while the engine is running.

(With START/STOP Switch Type)

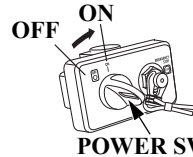

3. Insert the key to the power switch and turn it to the ON position.
4. Push the start/stop switch.

START/STOP SWITCH

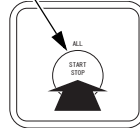

5. Before getting underway, allow the engine to warm-up sufficiently to ensure good performance.

Above 41°F (5°C), warm-up the engine for 2 or 3 minutes.

Below 41°F (5°C), warm-up the engine for at least 10 minutes at 2,000 rpm. Use the fast idle mode to achieve approximately 2,000 rpm.

OPERATION

NOTICE

- *If the engine is not properly warmed up before raising the engine speed, the buzzer and overheat indicator may activate and the engine speed will be automatically reduced.*
- *The cooling system may freeze in areas where the temperature reaches 32°F (0°C) or below. Cruising at high speed without warming the engine up may cause engine damage.*

During the warm-up period, check the oil pressure indicator (p. 48), overheat indicator (p. 49), and cooling system indicator (p. 49).

If the indicators show any abnormal condition, immediately stop the engine and determine the cause of the problem. Refer to *TAKING CARE OF UNEXPECTED PROBLEMS* on p. 115.

6. If the fast idle control was used to warm-up the engine, gradually return the control lever to the N (neutral) position as the engine warms up.

Side-Mount Type

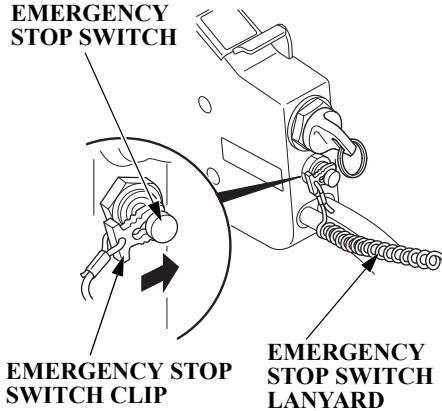

1. Put the emergency stop switch clip in the emergency stop switch, and attach the emergency stop switch lanyard securely to the operator or to the operator's PFD (Personal Flotation Device).

The engine will not start or run unless the emergency stop switch clip is in the emergency stop switch.

The emergency stop switch clip and emergency stop switch lanyard system is a safety device that will stop the engine if you fall away from the controls while operating the boat.

Always attach the emergency stop switch lanyard securely to the operator or to the operator's PFD before starting the engine.

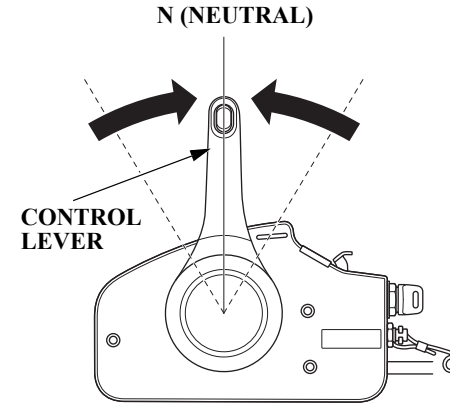

2. Set the control lever in the N (neutral) position.

The engine will not start if the F (forward) or R (reverse) gears are engaged.

OPERATION

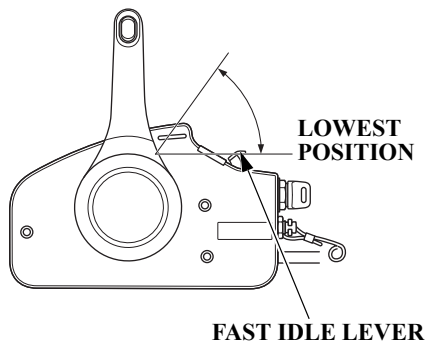

3. Leave the fast idle lever in the OFF (fully lowered) position.

The fast idle lever cannot be raised unless the control lever is in the N (neutral) position.

The control lever cannot be moved away from the N (neutral) position unless the fast idle lever is lowered.

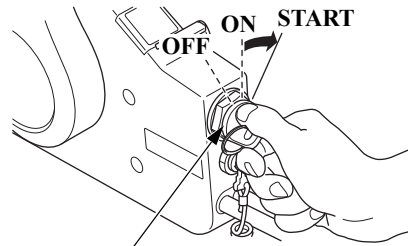

4. Turn the ignition switch key to the ON position; the buzzer will sound twice.
5. Turn the ignition switch key to the START position and hold it there until the engine starts.

When the engine starts, release the key, allowing it to return to the ON position.

If the engine fails to start within 5 seconds, release the key and wait at least 10 seconds before operating the starter again.

NOTICE

- Using the electric starter for more than 5 seconds at a time will overheat the starter motor and can damage it.
- Turning the ignition switch key to the START position while the engine is running can damage the starter motor and flywheel.

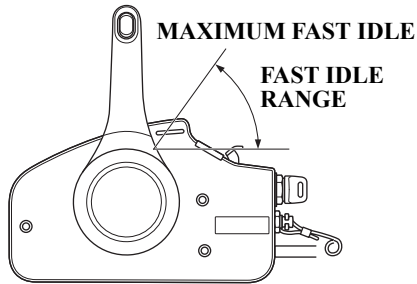

6. Before getting underway, allow the engine to warm-up sufficiently to ensure good performance.

Above 41°F (5°C), warm-up the engine for 2 or 3 minutes.

Below 41°F (5°C), warm-up the engine for at least 10 minutes at 2,000 rpm. Raise the fast idle lever to achieve approximately 2,000 rpm.

NOTICE

- *If the engine is not properly warmed up before raising the engine speed, the buzzer and overheat indicator may activate and the engine speed will be automatically reduced.*
- *The cooling system may freeze in areas where the temperature reaches 32°F (0°C) or below. Cruising at high speed without warming the engine up may cause engine damage.*

During the warm-up period, check the oil pressure indicator (p. 48), overheat indicator (p. 49), and cooling system indicator (p. 49).

If the indicators show any abnormal condition, immediately stop the engine and determine the cause of the problem. Refer to *TAKING CARE OF UNEXPECTED PROBLEMS* on p. 115.

7. If the fast idle lever was used to warm-up the engine, gradually lower the lever as the engine warms up.

When the fast idle lever is fully lowered, the control lever can be moved away from the N (neutral) position.

OPERATION

Flush-mount type (Mechanical wire type)

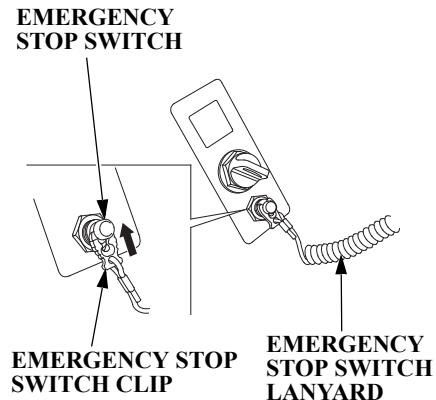

1. Put the emergency stop switch clip in the emergency stop switch, and attach the emergency stop switch lanyard securely to the operator or to the operator's PFD (Personal Flotation Device).

The engine will not start or run unless the emergency stop switch clip is in the emergency stop switch.

The emergency stop switch clip and emergency stop switch lanyard system is a safety device that will stop the engine if you fall away from the controls while operating the boat.

Always attach the emergency stop switch lanyard securely to the operator or to the operator's PFD before starting the engine.

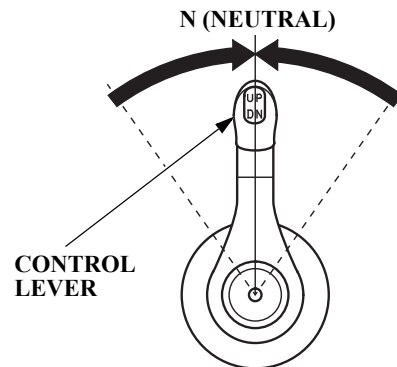

2. Set the control lever in the N (neutral) position.

The engine will not start if the F (forward) or R (reverse) gears are engaged.

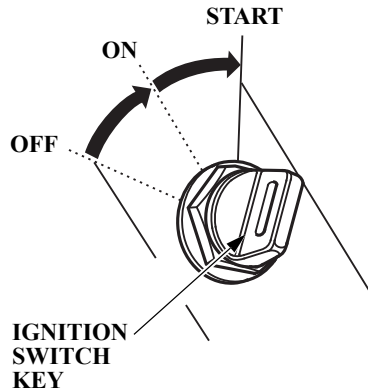

3. Turn the ignition switch key to the ON position; the buzzer will sound twice.
4. Turn the ignition switch key to the START position and hold it there until the engine starts.

When the engine starts, release the key, allowing it to return to the ON position.

If the engine fails to start within 5 seconds, release the key and wait at least 10 seconds before operating the starter again.

NOTICE

- *Using the electric starter for more than 5 seconds at a time will overheat the starter motor and can damage it.*
- *Turning the ignition switch key to the START position while the engine is running can damage the starter motor and flywheel.*

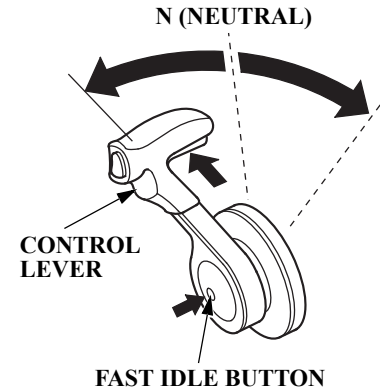

5. Before getting underway, allow the engine to warm-up sufficiently to ensure good performance.

Above 41°F (5°C), warm-up the engine for 2 or 3 minutes.

Below 41°F (5°C), warm-up the engine for at least 10 minutes at 2,000 rpm. Push the fast idle button, and then move the control lever forward or reverse to open the throttle and achieve approximately 2,000 rpm.

OPERATION

NOTICE

- *If the engine is not properly warmed up before raising the engine speed, the buzzer and overheat indicator may activate and the engine speed will be automatically reduced.*
- *The cooling system may freeze in areas where the temperature reaches 32°F (0°C) or below. Cruising at high speed without warming the engine up may cause engine damage.*

During the warm-up period, check the oil pressure indicator (p. 48), overheat indicator (p. 49), and cooling system indicator (p. 49).

If the indicators show any abnormal condition, immediately stop the engine and determine the cause of the problem. Refer to *TAKING CARE OF UNEXPECTED PROBLEMS* on p. 115.

6. If the fast idle control was used to warm-up the engine, gradually return the control lever to the N (neutral) position as the engine warms up.

Top-Mount Type (Mechanical wire type)

EMERGENCY STOP SWITCH

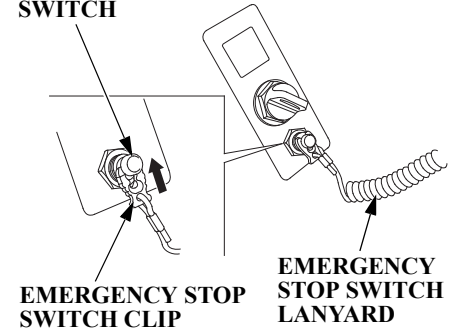

1. Put the emergency stop switch clip in the emergency stop switch, and attach the emergency stop switch lanyard securely to the operator or to the operator's PFD (Personal Flotation Device).

The engine will not start or run unless the emergency stop switch clip is in the emergency stop switch.

The emergency stop switch clip and emergency stop switch lanyard system is a safety device that will stop the engine if you fall away from the controls while operating the boat.

Always attach the emergency stop switch lanyard securely to the operator or to the operator's PFD before starting the engine.

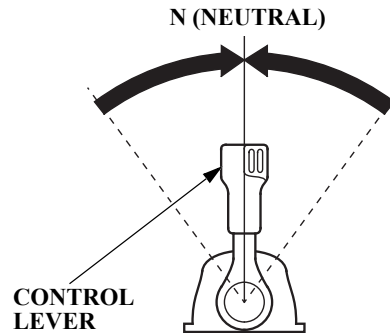

2. Set the control lever in the N (neutral) position.

The engine will not start if the F (forward) or R (reverse) gears are engaged.

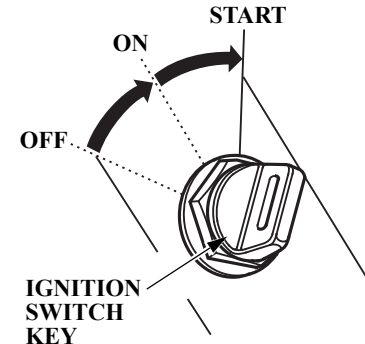

3. Turn the ignition switch key to the ON position; the buzzer will sound twice.
4. Turn the ignition switch key to the START position and hold it there until the engine starts.

When the engine starts, release the key, allowing it to return to the ON position.

OPERATION

If the engine fails to start within 5 seconds, release the key and wait at least 10 seconds before operating the starter again.

NOTICE

- Using the electric starter for more than 5 seconds at a time will overheat the starter motor and can damage it.
- Turning the ignition switch key to the START position while the engine is running can damage the starter motor and flywheel.

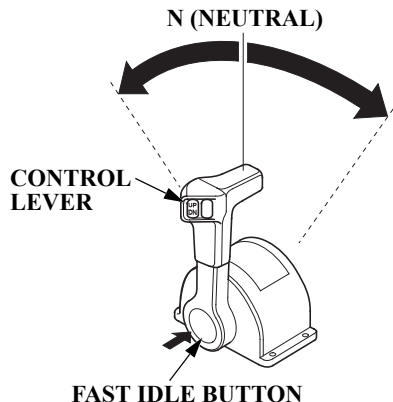

5. Before getting underway, allow the engine to warm-up sufficiently to ensure good performance.

Above 41°F (5°C), warm-up the engine for 2 or 3 minutes.

Below 41°F (5°C), warm-up the engine for at least 10 minutes at 2,000 rpm. Push the fast idle button, and then move the control lever forward or reverse to open the throttle and achieve approximately 2,000 rpm.

NOTICE

- If the engine is not properly warmed up before raising the engine speed, the buzzer and overheat indicator may activate and the engine speed will be automatically reduced.
- The cooling system may freeze in areas where the temperature reaches 32°F (0°C) or below. Cruising at high speed without warming the engine up may cause engine damage.

During the warm-up period, check the oil pressure indicator (p. 48), overheat indicator (p. 49), and cooling system indicator (p. 49).

If the indicators show any abnormal condition, immediately stop the engine and determine the cause of the problem. Refer to *TAKING CARE OF UNEXPECTED PROBLEMS* on p. 115.

6. If the fast idle control was used to warm-up the engine, gradually return the control lever to the N (neutral) position as the engine warms up.

Station Select Mode

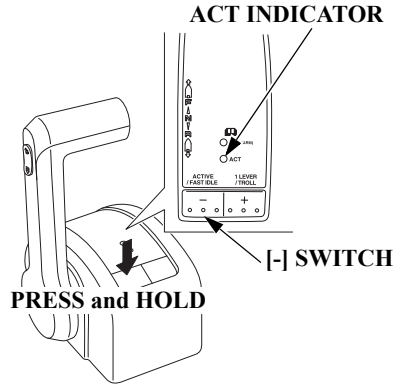

For multiple station type, use the [-] switch to change the operating station. If you press and hold the [-] switch of the inactive station when all remote control lever is in the NEUTRAL position, you can operate the outboard motors using this station. A long buzz sounds once and the ACT indicator comes on when the station can be operated.

STOPPING THE ENGINE

Emergency Engine Stopping

Flush-Mount Type, Top-Mount Type (DBW type)

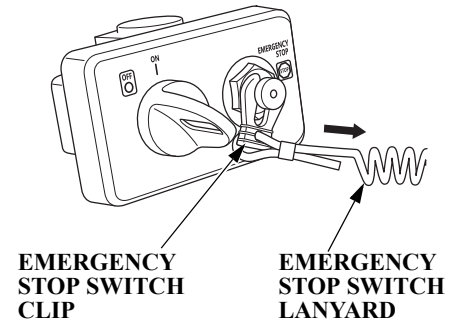

OPERATION

Side-Mount Type

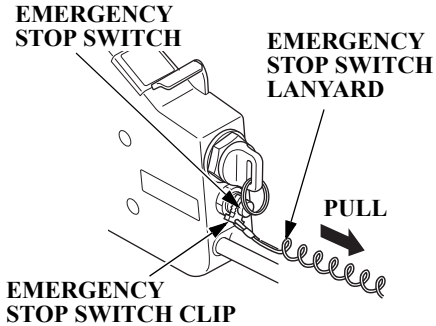

Flush-Mount, Top-Mount Type (Mechanical wire type)

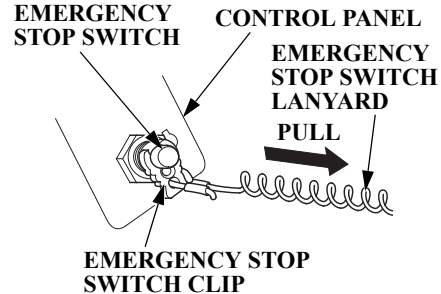

To stop the engine in an emergency, pull the emergency stop switch clip out of the emergency stop switch by pulling the emergency stop switch lanyard.

We suggest that you stop the engine this way occasionally to verify that the engine and emergency stop switch are operating properly.

Normal Engine Stopping (Flush-Mount Type, Top-Mount Type (DBW type))

Flush-Mount Type

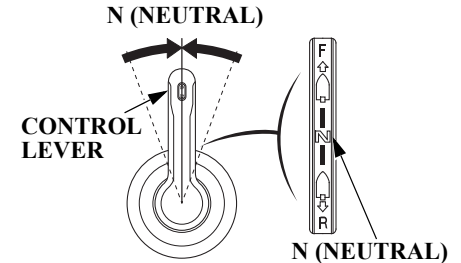

Top-Mount Type (DBW type)

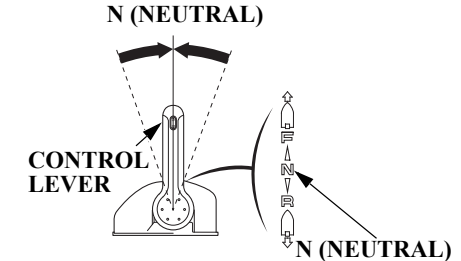

1. Move the control lever(s) to the N (neutral) position.

After cruising at full throttle, cool down the engine by idling for a few minutes before stopping the engine.

START/STOP SWITCH

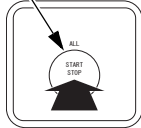

(with START/STOP switch)

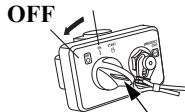

IGNITION SWITCH KEY

(without START/STOP switch)

(with START/STOP switch)

2. Push the start/stop switch to stop the engine.

In the event that the engine does not stop when the start/stop switch is pushed, disconnect the fuel line connector from the outboard motor.

(without START/STOP switch)

2. Turn the ignition switch key to the OFF position to stop the engine. In the event that the engine does not stop when the ignition switch key is turned to the OFF position, pull the emergency stop switch clip out of the emergency stop switch by pulling the emergency stop switch lanyard (p. 67).

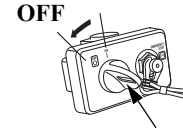

POWER SWITCH

(with START/STOP switch)

3. Turn the power switch key to the OFF position, and then remove and store it.

(without START/STOP switch)

3. When the boat is not in use, remove and store the ignition switch key and the emergency stop switch clip and lanyard.

OPERATION

Normal Engine Stopping
(Side-Mount Type, Flush-Mount Type, Top-Mount Type (Mechanical wire type))

Side-Mount Type

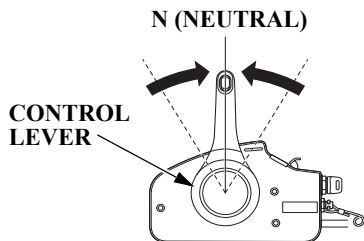

Flush-Mount Type (Mechanical wire type)

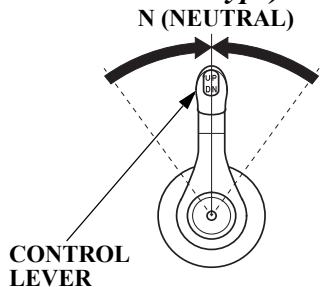

Top-Mount Type (Mechanical wire type)

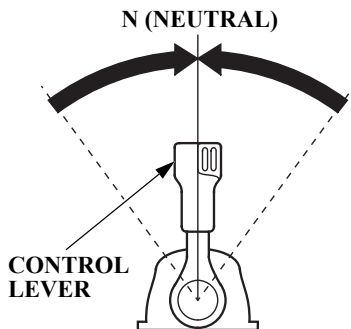

1. Move the control lever(s) to the N (neutral) position.

After cruising at full throttle, cool down the engine by idling for a few minutes before stopping the engine.

Side-Mount Type

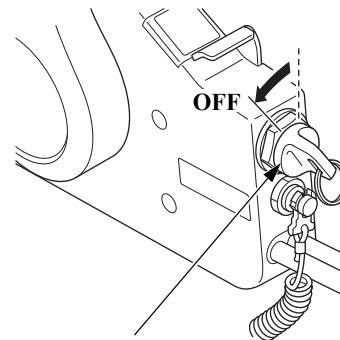

Flush-Mount, Top-Mount Type (Mechanical wire type)

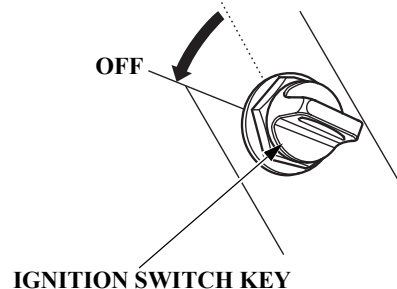

2. Turn the ignition switch key to the OFF position to stop the engine.
In the event that the engine does not stop when the ignition switch key is turned to the OFF position, pull the emergency stop switch clip out of the emergency stop switch by pulling the emergency stop switch lanyard (p. 68).
3. When the boat is not in use, remove and store the ignition switch key and the emergency stop switch clip and lanyard.

OPERATION

GEARSHIFT AND THROTTLE OPERATION

Flush-Mount Type (DBW type)

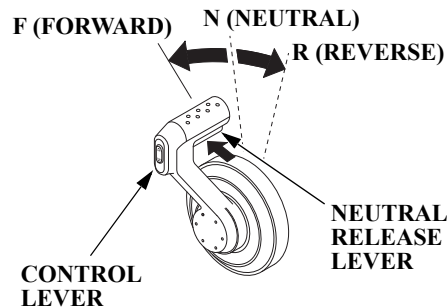

Top-Mount Type (DBW type)

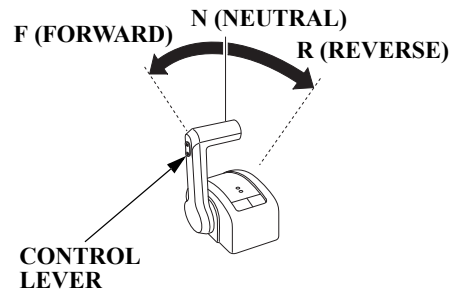

Side-Mount Type

CONTROL LEVER

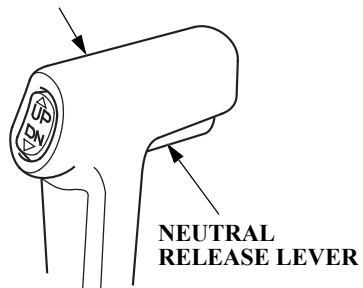

N (NEUTRAL)

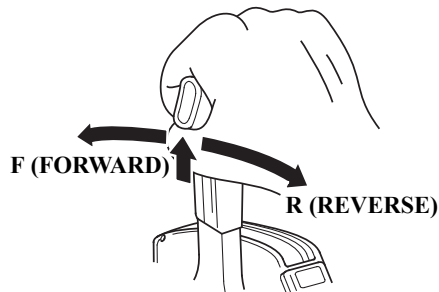

Flush-mount type (Mechanical wire type)

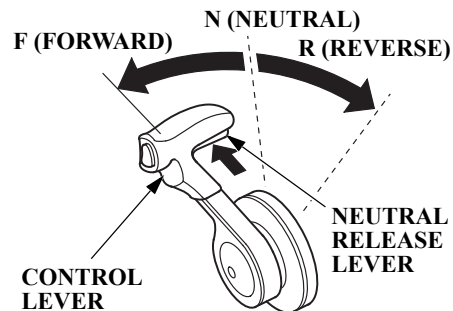

Top-Mount Type (Mechanical wire type)

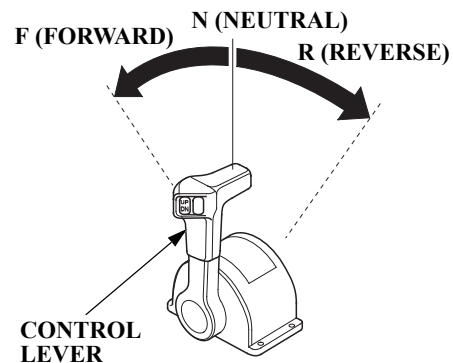

To shift gears, move the control lever to select the F (forward), N (neutral), or R (reverse) gear.

The control lever cannot be moved from the N (neutral) position unless the neutral release lever is squeezed (flush-mount/side-mount types).

Moving the control lever beyond the gear selection range increases engine speed.

Flush-Mount Type (DBW type)

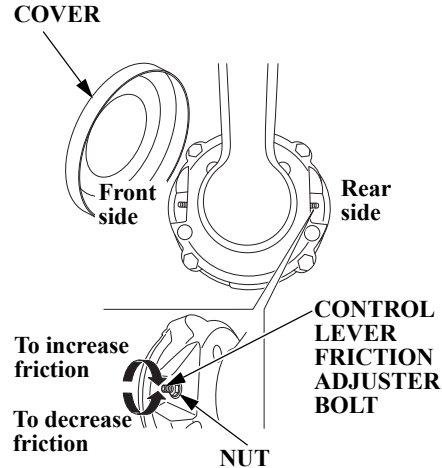

Top-Mount Type (DBW type)

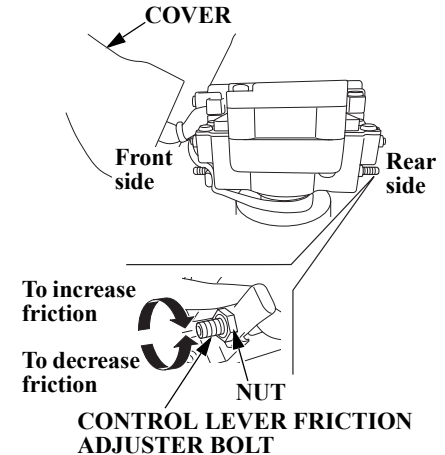

Check whether the control lever moves smoothly.

1. Remove the cover of the control lever.
2. Loosen the nut.
3. Adjust the lever friction when increasing throttle opening and boat speed by turning the control lever friction adjuster bolt right or left.
4. Tighten the nut to lock the lever friction.
5. Reinstall the cover of the control lever.

OPERATION

Side-Mount Type

CONTROL LEVER
FRICTION ADJUSTER

TO DECREASE
FRICTION

TO INCREASE
FRICTION

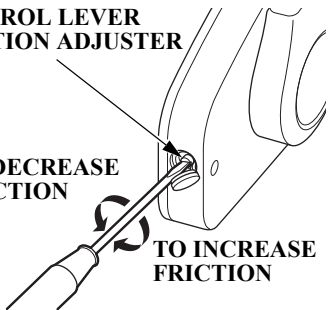

Flush-mount type (Mechanical wire type)

CONTROL LEVER
FRICTION ADJUSTER

TO INCREASE
FRICTION

TO DECREASE
FRICTION

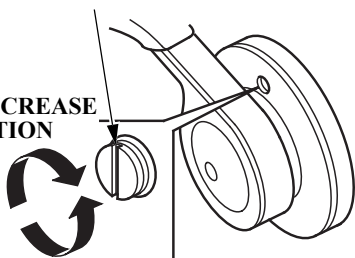

Top-Mount Type (Mechanical wire type)

TO INCREASE
FRICTION

TO DECREASE
FRICTION

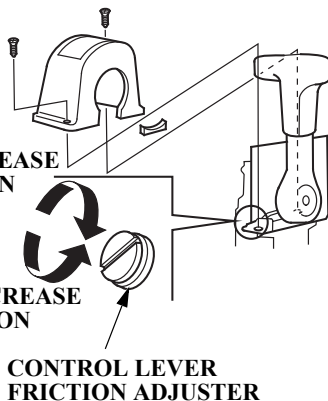

Adjust the control lever friction adjuster so the control lever will hold a constant throttle setting while cruising.

STEERING

Steer the boat in the same manner as an automobile.

CRUISING

Engine Speed

For best fuel economy, limit the throttle opening to 80%. Use the throttle friction control (p. 73) to help you hold a steady speed.

For rough water conditions or large waves, slow down to prevent the propeller from rising out of the water.

The engine is equipped with a rev limiter to prevent the possibility of mechanical damage from excessive engine speed.

If, for example, the outboard motor is tilted excessively or propeller ventilation occurs during a sharp turn, the engine may overrev, activating the rev limiter.

If engine speed becomes unstable at high speed due to activation of the rev limiter, reduce speed and check the trim angle of the outboard motor.

Trim

Use the power trim/tilt switch to trim the outboard motor for the best performance and stability.

You can use the power trim/tilt switch at any time, whether the boat is underway or stopped.

Press the UP or DN (down) side of the switch to adjust the angle of the outboard motor.

Refer to the trim meter (p. 44) for an indication of whether the outboard motor is trimmed high or low.

It is necessary to trim the angle of the outboard motor to compensate for changes in boat load, weight distribution, water conditions, or propeller selection.

Under normal conditions, the boat will perform best when the antiventilation plate is level with the water surface.

When cruising into a high wind, trim the outboard motor down slightly to level the boat and improve stability. With a tail wind, trim the outboard motor up slightly.

NOTICE

Excessive trim/tilt angle during operation can cause propeller ventilation, overheating, and water pump damage.

OPERATION

Flush-Mount Type (DBW type)

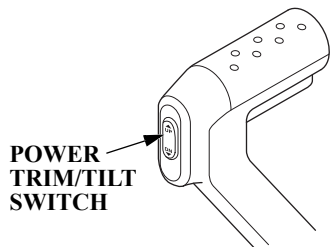

Single Top-Mount Type (DBW type)

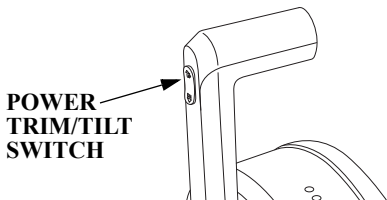

Dual Top-Mount Type (DBW type)

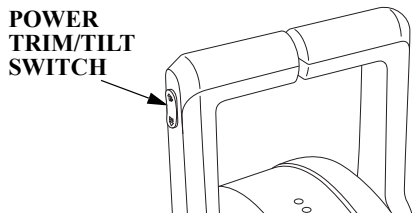

Side-Mount Type

POWER TRIM/TILT SWITCH

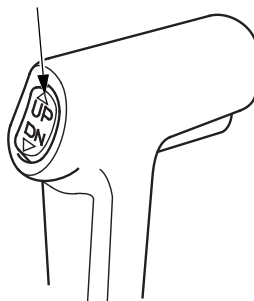

Flush-mount type (Mechanical wire type)

POWER TRIM/TILT SWITCH

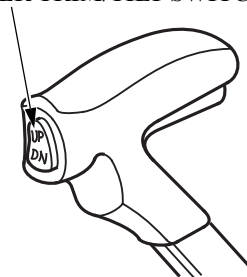

Single Top-Mount Type (Mechanical wire type)

POWER TRIM/TILT SWITCH

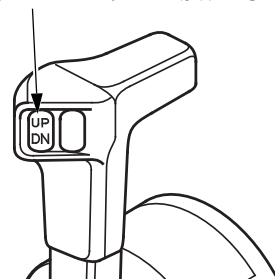

Dual Top-Mount Type (Mechanical wire type)

POWER TRIM/TILT SWITCH (LEFT) (RIGHT)

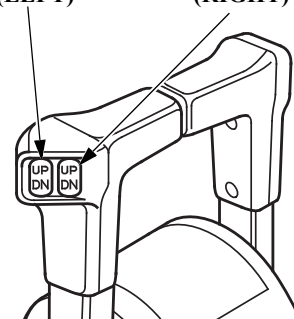

PTT Switch Panel

DUAL TYPE

Press UP to raise bow

Press DN to lower bow.

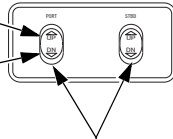

POWER TRIM/TILT SWITCH

TRIPLE TYPE

Press UP to raise bow

Press DN to lower bow.

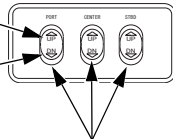

POWER TRIM/TILT SWITCH

For multiple outboard motors, the trim/tilt angle of all outboard motors is adjusted at the same time by using the power trim/tilt switch on the remote control lever and the trim/tilt angle of each outboard motor is adjusted by using each power trim/tilt switch on the panel.

OUTBOARD MOTOR TRIMMED TOO LOW



OUTBOARD MOTOR TRIMMED TOO HIGH



OUTBOARD MOTOR TRIMMED CORRECTLY



BOW TOO LOW DUE TO
1. LOAD IN THE FRONT
2. OUTBOARD MOTOR TRIMMED TOO LOW



BOW TOO HIGH DUE TO
1. LOAD IN THE REAR
2. OUTBOARD MOTOR TRIMMED TOO HIGH

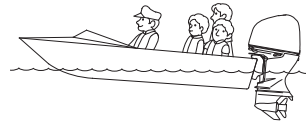

If steering effort is not equal in both directions, adjust the trim tab to compensate for “torque steer,” which is the reaction of the outboard motor to propeller rotation.

TRIM TAB BOLT

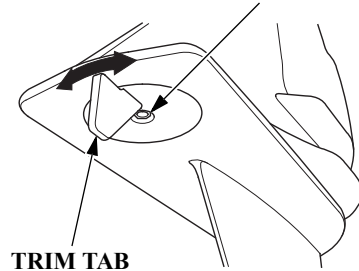

Adjust the trim tab with the engine stopped. Loosen the bolt above the trim tab, turn the trim tab, and then tighten the bolt securely.

When the trim tab is correctly adjusted, steering effort will be equal in both directions.

Refer to *TRIM TAB ADJUSTMENT* on p. 87.

OPERATION

TROLLING MODE

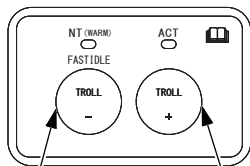

[-] SWITCH [+] SWITCH
(FLUSH-MOUNT type)

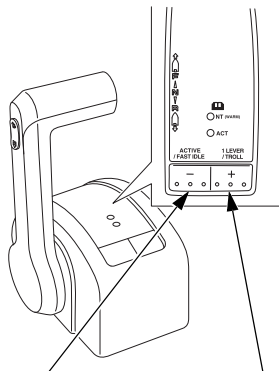

[-] SWITCH [+] SWITCH
(Top-Mount Type (DBW type))

[-] Switch: Reduce engine speed
[+] Switch: Increase engine speed

After the engine has warmed up, keeping [+] switch pushed when cruising with the throttle fully closed, changes the mode to trolling mode.

A long buzz sounds once. When the mode is changed to trolling mode, the engine speed is 650 min^{-1} (rpm).

You can adjust the engine speed by 50 min^{-1} (rpm) every time you press the switch once. You will hear a short buzz.

The engine speed can be adjusted within the range of $650 - 1,000 \text{ min}^{-1}$ (rpm).

Continuing to press the switch will not decrease or increase the engine speed beyond the lower (650 min^{-1} (rpm)) or higher ($1,000 \text{ min}^{-1}$ (rpm)) limit.

If you try to do this, a short buzz sounds twice.

The throttle may be operated while in trolling mode. The trolling mode is cancelled when you reach $3,000 \text{ min}^{-1}$ (rpm).

ONE-LEVER MODE (For multiple outboard motors type)

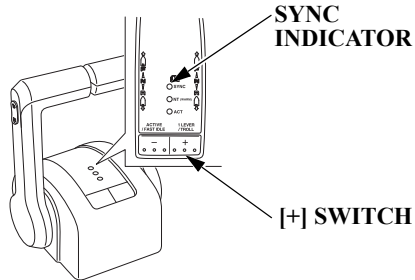

Shifting gear and the engine speed adjustment of the all outboard motors can be performed with one remote control lever when in one-lever mode.

If you press and hold the [+] switch when all remote control lever is in the NEUTRAL position, the mode changes to one-lever mode.

A long buzz sounds once and SYNC indicator comes on.

SHALLOW WATER OPERATION

When operating in shallow water, use the power trim/tilt switch (p. 75 – 76) to tilt the outboard motor so that the propeller and gear case won't hit the bottom.

Proceed at low speed, and monitor water flow from the cooling system indicator (p. 49) to be sure the outboard motor is not tilted so high that the water intakes are out of the water.

OPERATION

MOORING, BEACHING, LAUNCHING

Before tilting up, leave the outboard motor in the running position for one minute after stopping the engine to drain the water from inside the engine.

Stop the engine and disconnect the fuel hose from the outboard motor before tilting the outboard motor.

To raise the outboard motor out of the water while the engine is stopped and the boat is moored, or for maximum clearance when beaching or launching, use the power tilt switch on the engine pan to tilt the outboard motor up as far as it will go.

Move the tilt lock lever to the LOCK position, and then gently lower the outboard motor until the lever contacts the stern bracket. Use the power tilt switch to fully shorten the trim rods.

TRIM RODS

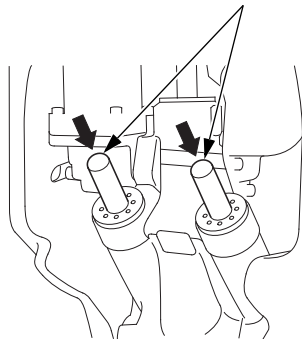

If more clearance is needed to swing the tilt lock lever into the LOCK position, rock the outboard motor forward slightly by pulling on the engine cover grip.

To lower the outboard motor, tilt up, move the tilt lock lever to the FREE position, and then lower the outboard motor to the desired position.

POWER TILT SWITCH

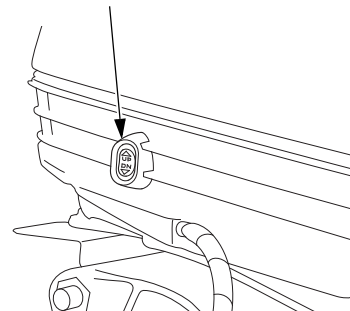

TILT LOCK LEVER
(Lock position)

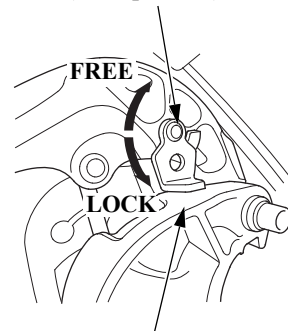

STERN BRACKET

NOTICE

Do not attempt to use the power tilt switch to tilt the outboard motor down while the tilt lock lever is in the LOCK position. Damage to the power tilt system may occur.

MANUAL RELIEF VALVE

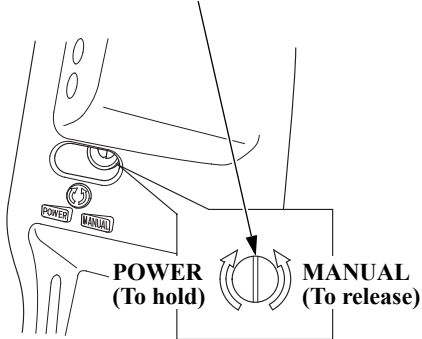

The outboard motor can also be tilted manually after opening the manual relief valve. This feature enables the outboard motor to be tilted up or down when no battery is connected.

For manual tilting, use a screwdriver to turn the valve counterclockwise 1 or 2 turns. Close the valve firmly after positioning the engine.

Be sure the valve is closed before operating the outboard motor. If the valve is not closed, the outboard motor will tilt up when operated in reverse.

Check that nobody is under the outboard motor before opening the manual relief valve. If the manual relief valve is loosened (turned counterclockwise) when the outboard motor is tilted up, the outboard motor will suddenly tilt down.

MULTIPLE OUTBOARD MOTORS

On boats equipped with more than one outboard motor, all motors normally operate at the same time.

If one or more motor(s) is stopped while the other(s) is running, put the stopped motor in “N” (neutral) and tilt it up so its propeller is above the water’s surface.

If the propeller of the stopped motor is left in the water, it may turn as the boat moves through the water, causing a reverse flow of water from the exhaust side. This reverse flow will happen if the stopped engine’s propeller is in the water, its gearshift is in “R” (reverse), and the boat is moving forward. Reverse flow can cause an engine malfunction.

SERVICING YOUR OUTBOARD MOTOR

THE IMPORTANCE OF MAINTENANCE

Proper maintenance is essential for safe, economical, and trouble-free operation. It will also help reduce air pollution.

WARNING

Failure to properly maintain this outboard motor, or failing to correct a problem before operation, could result in a significant malfunction.

Some malfunctions can cause serious injuries or death.

Always follow the inspection and maintenance recommendations and schedules in this owner's manual.

To help you properly care for your outboard motor, the following pages include a maintenance schedule, routine inspection procedures, and simple maintenance procedures using basic hand tools. Other service tasks that are more difficult or require special tools are best handled by professionals and are normally performed by a TOHATSU technician or other qualified mechanic.

The maintenance schedule applies to normal operating conditions. If you operate your outboard motor under unusual conditions, consult an authorized TOHATSU dealer for recommendations applicable to your individual needs and use.

Remember that your authorized TOHATSU dealer knows your outboard motor best and is fully equipped to maintain and repair it.

To ensure the best quality and reliability, use only new, TOHATSU Genuine parts or their equivalents for repair and replacement.

Maintenance, replacement, or repair of the emission control devices and systems may be performed by any marine engine repair establishment or individual, using parts that are “certified” to EPA standards.

SERVICING YOUR OUTBOARD MOTOR

MAINTENANCE SAFETY

Some of the most important safety precautions follow. However, we cannot warn you of every conceivable hazard that can arise in performing maintenance. Only you can decide whether or not you should perform a given task.

WARNING

Improper maintenance can cause an unsafe condition.

Failure to properly follow maintenance instructions and precautions can cause serious injuries or death.

Always follow the procedures and precautions in this owner's manual.

Safety Precautions

- Make sure the engine is off before you begin any maintenance or repairs. This will eliminate several potential hazards:
 - **Carbon monoxide poisoning from engine exhaust.**
Do not start or run the engine in a confined or partly enclosed area.
 - **Burns from hot parts.**
Let the engine and exhaust system cool before touching.
 - **Injury from moving parts.**
Do not run the engine unless instructed to do so.
- Read the instructions before you begin, and make sure you have the tools and skills required.
- To reduce the possibility of fire or explosion, be careful when working around gasoline. Use only a nonflammable solvent, not gasoline, to clean parts. Keep cigarettes, sparks, and flames away from all fuel-related parts.
- Wear gloves when handling the propeller to protect your hands from sharp edges.

SERVICING YOUR OUTBOARD MOTOR

TOOL KIT and OWNER'S MANUAL

(Tool kit does not come with Counter Rotation Types)



OWNER'S MANUAL



10 mm BOX WRENCH



PHILLIPS SCREWDRIVER



GRIP



6 mm HEX. WRENCH

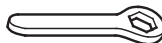

19 mm EYE WRENCH



SPARK PLUG WRENCH



TOOL BAG

The tool kit can be used for simple maintenance procedures and emergency repairs. Keep these items on the boat so that they will always be available if you need them.

If your tool kit needs replacement, it is not available as a kit and each item must be ordered individually.

SPARE EMERGENCY STOP SWITCH CLIP

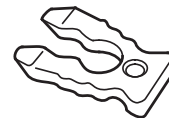

Always carry a spare emergency stop switch clip onboard. The spare clip may either be stored in the tool bag or in an easily accessible location on the boat.

SERVICING YOUR OUTBOARD MOTOR

MAINTENANCE SCHEDULE

Follow the MAINTENANCE SCHEDULE table and service your outboard motor accordingly.

REGULAR SERVICE PERIOD (3) Perform at every indicated month or operating hour interval, whichever comes first.		Each use	After use	First month or 20 hrs.	Every 6 months or 100 hrs.	Every year or 200 hrs.	Every 2 years or 400 hrs.	Every 3 years or 600 hrs.	Every 6 years or 1,200 hrs.
ITEM									
Engine oil	Check level	o							
	Change			o	o				
Engine oil filter	Replace					o (2)			
Gear case oil	Change			o (2)	o (2)				
Timing belt	Check-adjust					o (2)			
ACG belt	Check-adjust					o (2)			
Throttle linkage and Control Cable (9)	Check-adjust			o (2)	o (2)				
Valve clearance	Check-adjust					o (2)			
Spark plug (nickel)	Check-adjust/Replace				o				
Spark plug (iridium) (Optional part)	Check					o			
(Optional part)	Replace						o		
Propeller and Cotter pin	Check	o				o			
Anode metal (Outside engine) (6)	Check	o				o			
Anode metal (Inside engine) Sleeve (6)	Check						o (2)		
Exhaust manifold	Check						o (2)		
V bank bottom	Replace								o (2)
Idling speed	Check-adjust			o (2)	o (2)				
Lubrication	Grease			o (1)	o (1)				

Note:

- (1) Lubricate more frequently when used in salt water.
- (2) These items should be serviced by your servicing dealer, unless you have the proper tools and are mechanically proficient. Refer to the TOHATSU Service Manual for service procedures.
- (3) For professional commercial use, log hours of operation to determine proper maintenance intervals.
- (6) Replace the anodes when they have been reduced to about two-thirds of their original size, or if they are crumbling.
- (9) Mechanical Remote Control type only.

SERVICING YOUR OUTBOARD MOTOR

REGULAR SERVICE PERIOD (3) Perform at every indicated month or operating hour interval, whichever comes first.		Each use	After use	First month or 20 hrs.	Every 6 months or 100 hrs.	Every year or 200 hrs.	Every 2 years or 400 hrs.	Every 3 years or 600 hrs.	Every 6 years or 1,200 hrs.
ITEM									
Fuel filter with water separator (Low pressure side)	Check	o			o				
	Replace						o		
Fuel filter (High pressure side)	Replace						o (2)		
Thermostat and thermostat cover	Check/Replace					o (2)			
Fuel line	Check	o (7)							
	Replace		Every 2 years (If necessary) (2) (8)						
Battery and cable connection	Check level-tightness	o							
Bolts and Nuts	Check-tightness			o (2)	o (2)				
Crankcase breather tube	Check					o (2)			
Cooling water passages	Clean		o (4)		o (4)				
Coolant leak	Check	o							
Water pump and Woodruff Key	Check					o (2)			
Housing, Impeller	Check					o (2)			
Emergency stop switch	Check	o							
Engine oil leak	Check	o							
Each operation part	Check	o							
Engine condition (5)	Check	o							
Power Trim/Tilt	Check				o (2)				
Shift Cable (9)	Check-adjust				o (2)				

Note:

- (2) These items should be serviced by your servicing dealer, unless you have the proper tools and are mechanically proficient. Refer to the TOHATSU Service Manual for service procedures.
- (3) For professional commercial use, log hours of operation to determine proper maintenance intervals.
- (4) When operating in salt water, turbid or muddy water, the engine should be flushed with clean water after each use.
- (5) Upon starting, check for unusual engine sounds and cooling water flowing freely from the check hole.
- (7) Check the fuel line for leaks, cracks, or damage. If it is leaking, cracked, or damaged, take it to your servicing dealer for replacement before using your outboard.
- (8) Replace the fuel line if there are signs of leaks, cracks, or damage.
- (9) Mechanical Remote Control type only.

SERVICING YOUR OUTBOARD MOTOR

TRIM TAB ADJUSTMENT

The trim tab compensates for “torque steer,” which is a reaction of the outboard motor to propeller rotation.

If uncompensated, torque steer would make the outboard motor tend to turn to one side.

When the trim tab is correctly adjusted, steering effort is equal in either direction.

If steering effort is unequal, loosen the trim tab bolt and adjust the angle of the trim tab. Retighten the trim tab bolt securely.

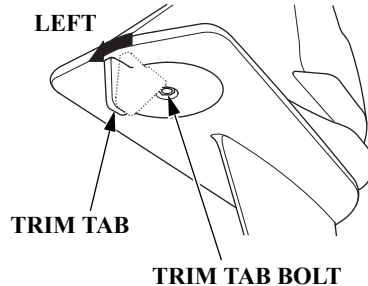

If less effort is required to make left turns, move the back of the trim tab left.

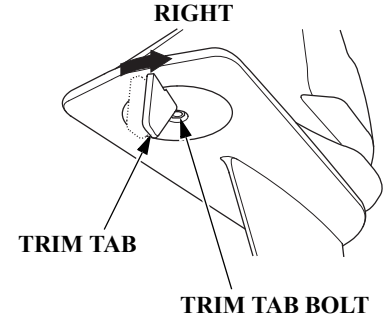

If less effort is required to make right turns, move the back of the trim tab right.

Adjust the trim tab in small increments, and retest steering effort with the boat evenly loaded and running at cruising speed.

SERVICING YOUR OUTBOARD MOTOR

MANUAL RELIEF VALVE

MANUAL RELIEF VALVE

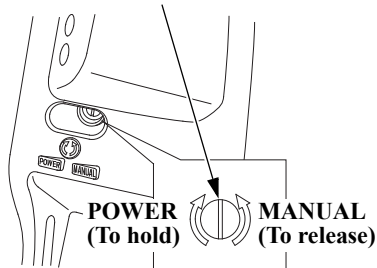

The outboard motor can be tilted manually after opening the manual relief valve. This feature enables the outboard motor to be tilted up or down when no battery is connected.

For manual tilting, use a screwdriver to turn the valve counterclockwise 1 or 2 turns. Close the valve firmly after positioning the outboard motor.

Be sure the valve is closed before operating the outboard motor. If the valve is not closed, the outboard motor will tilt up when operated in reverse.

ENGINE COVER REMOVAL AND INSTALLATION

Removal

Front

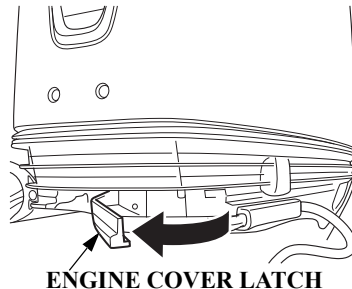

Side

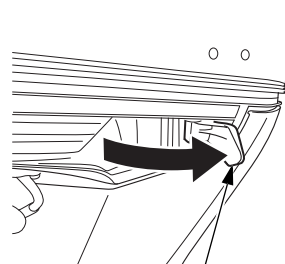

ENGINE COVER LATCH (each side)

1. Pull all the engine cover latches.
2. Remove the engine cover by lifting it straight up from the outboard motor.

Installation

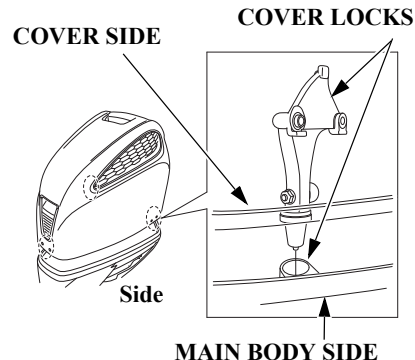

1. Place the engine cover on the main body.
2. Slide the engine cover so that the cover lock on the cover aligns with the lock in the main body.

Front

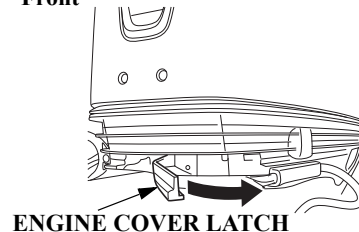

SERVICING YOUR OUTBOARD MOTOR

Side

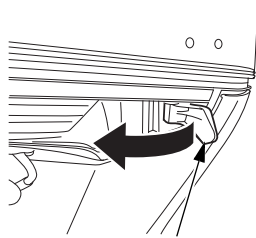

ENGINE COVER LATCH (each side)

3. Push the engine cover until any gap between the engine cover and main body is eliminated.
4. Push all the engine cover latches to lock them.

Lubricate the engine cover rubber sealing ring with silicone spray to make installation easier.

The cover should be tight at the mid-case point. If the cover is loose or difficult to secure, an adjustment may be necessary. Please see the service manual or your TOHATSU dealer for adjustment.

Engine Oil Level Check

Check the engine oil level with the engine stopped and the outboard motor in the vertical position.

1. Unlock and remove the engine cover (p. 88).
2. Remove the dipstick and wipe it clean.

OIL LEVEL DIPSTICK

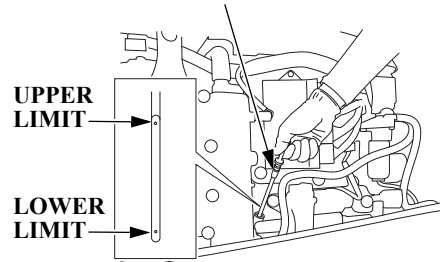

3. Insert the dipstick all the way in, then remove it and check the oil level shown on the dipstick.

OIL FILLER CAP

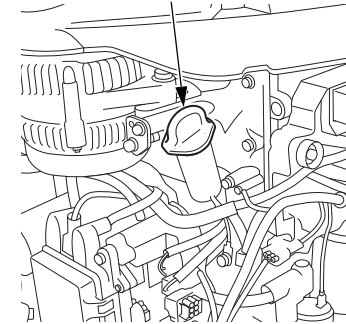

4. If the oil level is low, remove the oil filler cap, and add oil to reach the upper limit mark shown on the dipstick. Use the oil recommended on p. 93.

NOTICE

- *Running the engine with a low oil level can cause engine damage.*
- *Do not overfill. Overfilling the engine will cause it to smoke or have oil leaks.*

SERVICING YOUR OUTBOARD MOTOR

5. Install the oil filler cap and tighten it securely. Do not overtighten.

6. Install and lock the engine cover (p. 88).

When you check the oil level with the dipstick, you might notice the engine oil appears milky or the oil level has increased. If you notice either condition, change the engine oil. See the following table for an explanation of these conditions.

Operating Method	Result	Effect
Running the engine below 3,000 rpm for more than 30% of the time so the engine does not warm up.	<ul style="list-style-type: none">• Water condenses in the engine and mixes with the oil, resulting in a milky appearance.• Unburned fuel mixes with the oil, increasing the volume of oil.	The engine oil deteriorates, becomes less efficient as a lubricant, and causes an engine malfunction.
Frequent starting and stopping without allowing the engine to warm up.		

SERVICING YOUR OUTBOARD MOTOR

Engine Oil Change

An engine oil evacuation/filling device may be used to remove/add the engine oil.

Drain the used oil while the engine is warm. Warm oil drains quickly and completely.

1. Unlock and remove the engine cover (p. 88).

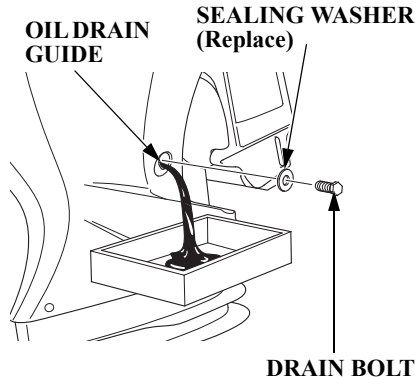

2. Place a suitable container below the oil drain guide to catch the used oil, and then remove the oil filler cap (p. 89), drain bolt, and sealing washer.
3. Allow the used oil to drain completely. Use a new sealing washer, and then reinstall the engine oil drain bolt and washer. Tighten the drain bolt securely.

TIGHTENING TORQUE:
17 lbf·ft (23 N·m, 2.3 kgf·m)

NOTICE

Improper disposal of engine oil can be harmful to the environment. If you change your own oil, please dispose of the used oil properly. Put it in a sealed container, and take it to a recycling center. Do not throw it in the trash, pour it on the ground or down a drain.

4. Install the drain bolt cover and secure it with the screw.
5. With the outboard motor in a vertical position, fill to the upper limit mark on the dipstick (p. 89) with the recommended oil.
Engine oil refill capacity:
Without oil filter change:
8.0 US qt (7.6 L)
With oil filter change:
8.2 US qt (7.8 L)
6. Install the oil filler cap and tighten it securely.

SERVICING YOUR OUTBOARD MOTOR

7. Install and lock the engine cover (p. 88).

Oil Filter Change

1. Drain the engine oil, and reinstall the drain bolt, washer, and drain bolt cover (see *Engine Oil Change* on p. 91).
2. Tilt the outboard motor, and place a suitable container below the oil drain guide to catch the used oil.
3. Use a suitable tool to remove the oil filter, and thoroughly drain the filter into the used oil container.

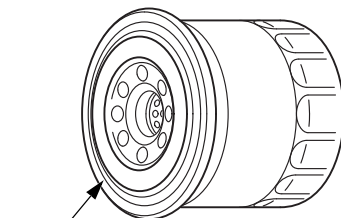
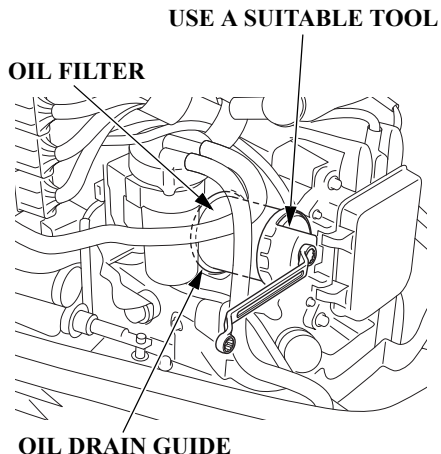

4. Clean the oil filter mounting base, and coat the rubber seal of the new oil filter with clean engine oil.

NOTICE

Use only a TOHATSU Genuine oil filter or a filter of equivalent quality specified for your model. Using the wrong filter, or a non-TOHATSU filter which is not of equivalent quality, may cause engine damage.

5. Screw on the new filter by hand until it contacts the engine, then use a suitable tool to tighten the filter an additional 7/8 turn.

TIGHTENING TORQUE:
9 lbf·ft (12 N·m, 1.2 kgf·m)

SERVICING YOUR OUTBOARD MOTOR

- Return the outboard motor to the vertical position, and fill the crankcase with the specified amount (p. 91) of the recommended oil.

NOTICE

Do not overfill. Overfilling the engine will cause it to smoke or have oil leaks.

- Start the engine and check for leaks.

NOTICE

Running the engine without water can cause serious engine damage. If you are changing the oil filter while the outboard motor is out of the water, use commercially available earmuffs and a hose to supply water.

- Stop the engine, and check the oil level as described on page 89. If necessary, add oil to bring the oil level to the upper limit mark on the dipstick.

Engine Oil Recommendations

Oil is a major factor affecting performance and service life. Use 4-stroke detergent oil.

Use 4-stroke high detergent, premium quality motor oil certified to meet or exceed U.S. automobile manufacturer's requirements for API Service category SG, SH, SJ or SL. Motor oils classified SG, SH, SJ or SL will show this designation on the container.

SAE 10W-30 is recommended for general use.

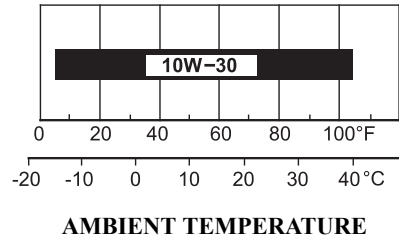

SERVICING YOUR OUTBOARD MOTOR

Lubrication Points

Apply TOHATSU Marine grease to the parts shown below:

Lubrication interval:

After the first 20 hours or 1 month, then every 100 hours or 6 months (refer to the *MAINTENANCE SCHEDULE* on page 85).

NOTICE

Apply anticorrosion oil to pivot surfaces where grease cannot penetrate.

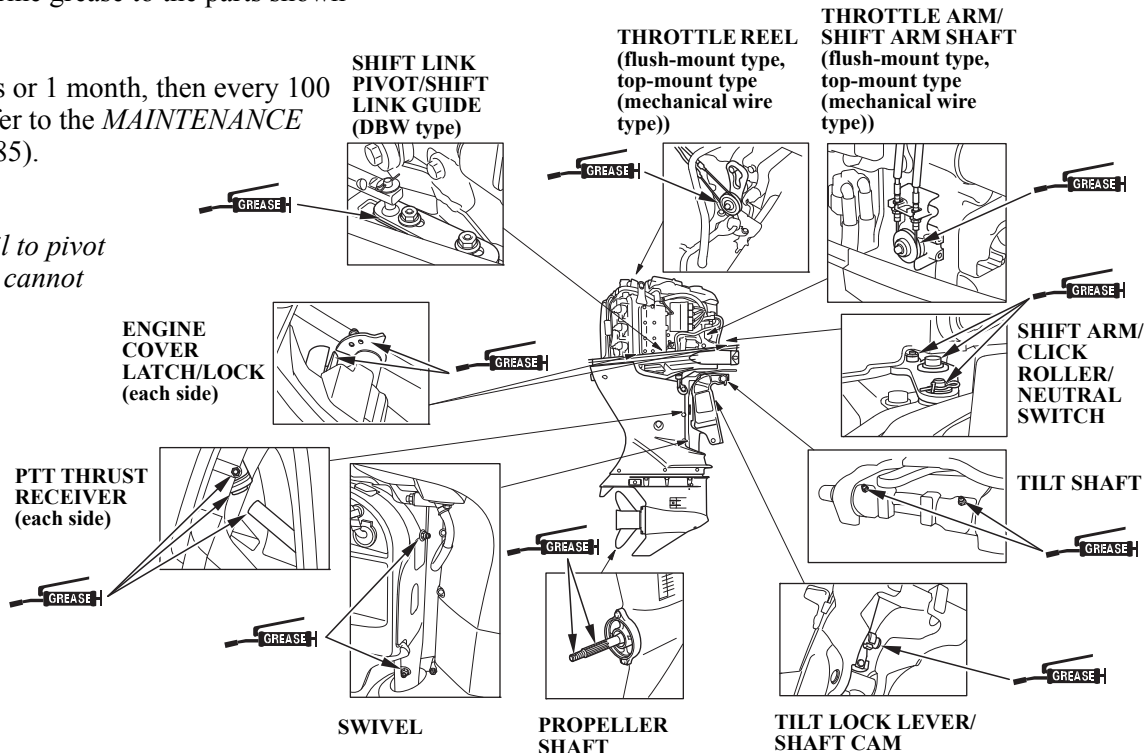

Apply corrosion inhibitor to all areas under the engine cover and any exposed metal surfaces except the belts.

SERVICING YOUR OUTBOARD MOTOR

Spark Plug Service <Standard Spark Plug>

RECOMMENDED SPARK PLUGS:
ZFR6K-11E (NGK)

NOTICE

Incorrect spark plugs can cause engine damage.

See page 98 for instructions of handling the Iridium spark plugs (optional parts).

1. Disconnect the battery negative (-) terminal.
2. Unlock and remove the engine cover (p. 88).

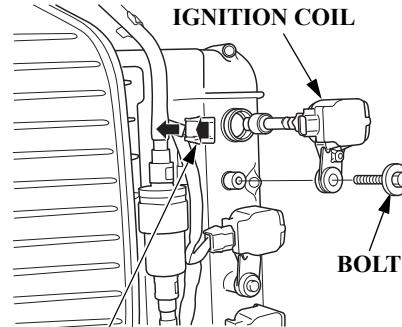

WIRE CONNECTOR

3. Disconnect the wire connector from the ignition coil by pushing on the lock tab and pulling on the connector. Pull on the plastic connector, not the wires.
4. Remove the bolt with a 10 mm wrench. Remove the ignition coil by pulling it up slightly.

NOTICE

Do not strike or drop the ignition coil, or it may be damaged and require replacement.

SERVICING YOUR OUTBOARD MOTOR

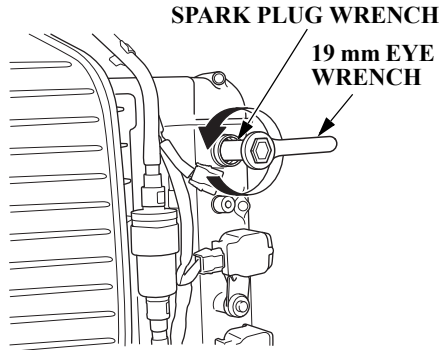

5. Remove the spark plugs with a spark plug wrench and 19 mm eye wrench.

New plug

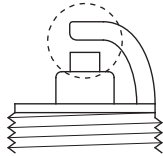

Plug needing replacement

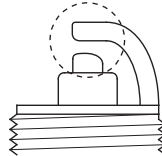

6. Inspect the spark plugs. Replace them if the electrodes are worn, or if the insulators are cracked or chipped.

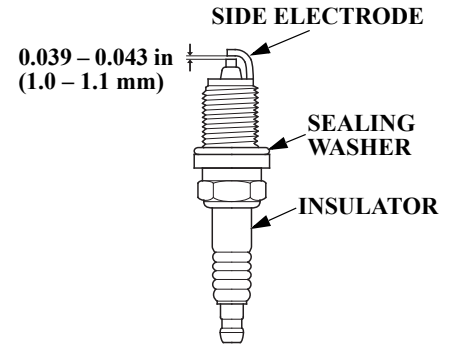

7. Measure the spark plug electrode gap with a wire-type feeler gauge. Correct the gap, if necessary, by carefully bending the side electrode.
The gap should be:
0.039 - 0.043 in (1.0 - 1.1 mm)

SERVICING YOUR OUTBOARD MOTOR

8. Install the spark plugs carefully, by hand, to avoid cross-threading.
9. After each spark plug seats, tighten with the spark plug wrench supplied in the tool kit to compress the sealing washer.

If reinstalling used spark plugs, tighten 1/8 – 1/4 turn after the spark plugs seat.

If installing new spark plugs, tighten 1/2 turn after the spark plugs seat.

TIGHTENING TORQUE:
13 lbf·ft (18 N·m, 1.8 kgf·m)

NOTICE

*Loose spark plugs can overheat and damage the engine.
Overtightening the spark plugs can damage the threads in the cylinder head.*

10. Install the ignition coil. Reinstall the bolt.
11. Push the wire connector onto the ignition coil. Make sure it locks in place.
12. Repeat this procedure for the other five spark plugs.
13. Reinstall the engine cover.

SERVICING YOUR OUTBOARD MOTOR

<Optional Parts: Iridium Spark Plug>

RECOMMENDED SPARK PLUGS:
IZFR6K-11E (NGK)

NOTICE

Incorrect spark plugs can cause engine damage.

Installation and removal procedure of the Iridium spark plugs are the same as the standard spark plugs.

These spark plugs have an iridium coated center electrode.

Be sure to observe the following when servicing iridium spark plugs.

- Do not clean the spark plugs. If an electrode is contaminated with accumulated objects or dirt, replace the spark plug with a new one.

- Use only a “wire-type feeler gauge” to check the spark plug gap if necessary. To prevent damaging the iridium coating of the center electrode, never use a “leaf-type feeler gauge.”
The gap should be 0.039 – 0.043 inches (1.0 – 1.1 mm).
- Do not adjust the spark plug gap. If the gap is out of specification, replace the spark plug with a new one.

SERVICING YOUR OUTBOARD MOTOR

REFUELING

Check the fuel level and refill if necessary. Do not fill the fuel tank above the UPPER LIMIT. Refer to the boat manufacturer's instructions.

⚠ WARNING

Gasoline is highly flammable and explosive.

You can be burned or seriously injured when handling fuel.

- Stop the engine and let it cool before handling fuel.
- Keep heat, sparks, and flame away.
- Handle fuel only outdoors.
- Keep away from your vehicle.
- Wipe up spills immediately.

Never refill the fuel tank inside a building where gasoline fumes may reach flames or sparks. Keep gasoline away from appliance pilot lights, barbecues, electric appliances, power tools, etc.

Spilled fuel is not only a fire hazard, it causes environmental damage. Wipe up spills immediately.

SERVICING YOUR OUTBOARD MOTOR

FUEL RECOMMENDATIONS

Use unleaded gasoline with a pump octane rating of 86 or higher.

Your outboard motor is certified to operate on unleaded gasoline. Unleaded gasoline produces fewer engine and spark plug deposits and extends exhaust system life.

Never use gasoline that is stale, contaminated, or mixed with oil. Avoid getting dirt or water in the fuel tank.

You may use unleaded gasoline containing no more than 10% ethanol (E10) or 5% methanol by volume. In addition, methanol must contain cosolvents and corrosion inhibitors.

Use of fuels with content of ethanol or methanol greater than shown above may cause starting and/or performance problems. It may also damage metal, rubber, and plastic parts of the fuel system.

Engine damage or performance problems that result from using a fuel with percentages of ethanol or methanol greater than shown above are not covered under warranty.

If your outboard motor will be used on an infrequent or intermittent basis, please refer to the fuel section of the *STORAGE* chapter (p. 109) for additional information regarding fuel deterioration.

Fuel Filter with Water Separator Inspection and Replacement

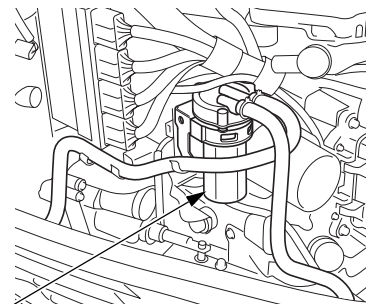

FUEL FILTER with WATER SEPARATOR

The fuel filter with water separator is located near the junction box.

Water or sediment accumulation in the fuel filter with water separator can cause loss of power or hard starting. To prevent engine malfunction, inspect the fuel filter with water separator and replace when necessary.

SERVICING YOUR OUTBOARD MOTOR

⚠ WARNING

Gasoline is highly flammable and explosive.

You can be burned or seriously injured when handling fuel.

- Stop the engine and let it cool before handling fuel.
- Keep heat, sparks, and flame away.
- Handle fuel only outdoors.
- Keep away from your vehicle.
- Wipe up spills immediately.

<Inspection>

Front

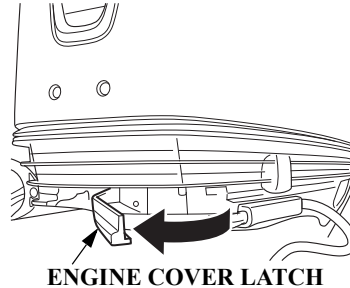

Side

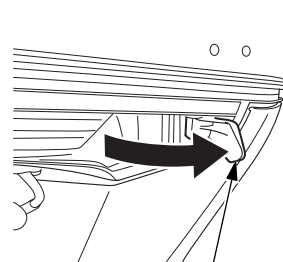

ENGINE COVER LATCH (each side)

1. Remove the engine cover (p. 88).

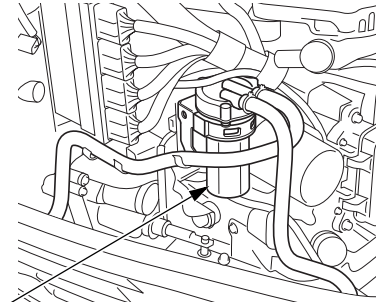

FUEL FILTER with WATER SEPARATOR

2. Looking through the translucent strainer cup, check the fuel filter with water separator for water accumulation or sediment.

If the fuel filter with water separator is clogged, refer to fuel filter with water separator replacement procedure (p. 102) to remove the filter and clean it.

SERVICING YOUR OUTBOARD MOTOR

If water is present in the fuel filter with water separator, refer to fuel filter with water separator replacement procedure to remove the strainer cup and empty the water from the inside of the cup.

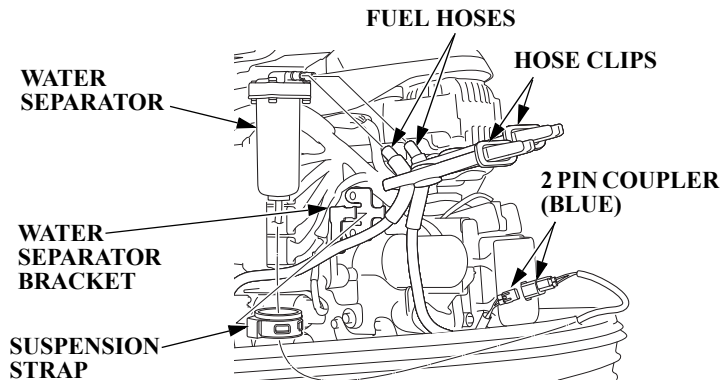

<Replacement>

1. Remove the engine cover (p. 88).
2. Disconnect the 2 pin coupler (blue).
3. Remove the suspension strap from the fuel filter with water separator bracket, and then remove the suspension strap from the fuel filter with water separator.

4. Bind the two fuel hoses with hose clips to prevent fuel leakage, and disconnect the fuel hoses.

SERVICING YOUR OUTBOARD MOTOR

WATER SEPARATOR CUP

O-RING (Replace)

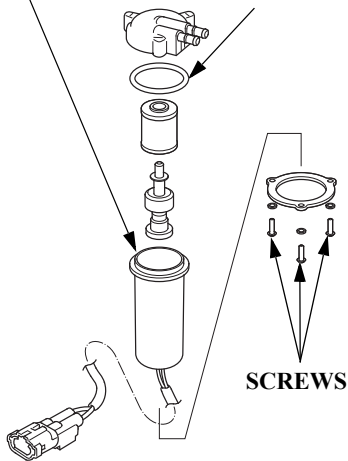

SCREWS

5. Remove the three screws holding the fuel filter with water separator, empty the water or deposits from the inside of the cup.

6. Thoroughly clean the cup, and replace with a new fuel filter.
7. Reassemble the fuel filter with water separator in the reverse order of removal. Use a new O-ring.
TIGHTENING TORQUE:
2.5 lbf·ft (3.4 N·m, 0.35 kgf·m)

ALIGNING MARK

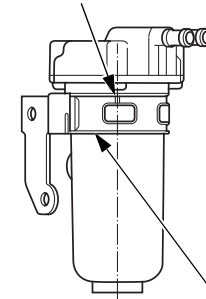

SUSPENSION STRAP

8. Position the aligning mark as shown in the figure when installing the suspension strap on the fuel filter with water separator.
9. Prime the engine using the priming bulb (p.55). Check for fuel leaks. Repair any fuel leaks if necessary.

SERVICING YOUR OUTBOARD MOTOR

If the buzzer sounds or water or sediment accumulation is found in the fuel filter with water separator, inspect the fuel tank.

Clean the fuel tank and tank filter if necessary. It may be necessary to drain the fuel tank completely and refill with fresh gasoline.

Anode Replacement

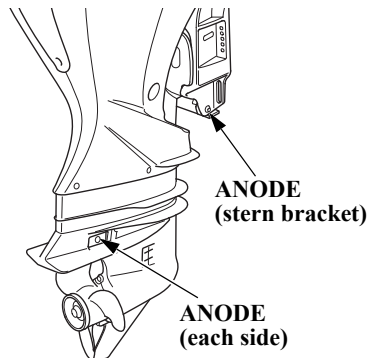

The anodes are located on each side of the gear case. They are made of a sacrificial material that helps to protect the outboard motor from corrosion.

Replace the anodes when they have been reduced to about two-thirds of their original size, or if they are crumbling.

NOTICE

Painting or coating the anodes will defeat their purpose and will lead to rust and corrosion damage to the outboard motor. The anodes must be exposed to the water in order to protect the outboard motor.

Propeller Replacement

Before replacing the propeller, remove the emergency stop switch clip from the emergency stop switch to prevent any possibility of the engine being started while you are working with the propeller.

The propeller blades may have sharp edges, so wear heavy gloves to protect your hands.

Operating the outboard motor at higher altitudes will reduce available power. This may require decreasing the propeller pitch to maintain correct engine RPM.

Removal

1. Remove the cotter pin, unscrew the castle nut, remove the washer, and then remove the propeller and thrust washer.
2. Inspect the propeller shaft for any fishing line or debris.

Installation

Some propeller brands require specific mounting hardware. Refer to your specific propeller manufacturer's instructions for proper installation.

1. Apply marine grade grease to the propeller shaft.
2. Install the thrust washer with the grooved side toward the gear case.
3. Install the propeller.
4. Install the washer as shown on the next page.
5. Lightly tighten the castle nut by hand or wrench until the propeller has no free play.
6. Tighten the castle nut using a torque wrench.
TIGHTENING TORQUE:
0.7 lbf·ft (1.0 N·m, 0.1 kgf·m)

7. Then, using a torque wrench, tighten the castle nut until the first available groove in the castle nut aligns with the cotter pin hole. Do not tighten past the first alignment of the castle nut groove and the cotter pin hole.

NOTICE

TIGHTENING TORQUE LIMIT:
33 lbf·ft (44 N·m, 4.5 kgf·m)
Do not tighten the castle nut above the TIGHTENING TORQUE LIMIT, or the propeller and shaft may be damaged.

8. Be sure to replace the cotter pin with a new one.
 - Use a TOHATSU Genuine stainless steel cotter pin or equivalent cotter pin and bend the pin ends as shown on next page.

SERVICING YOUR OUTBOARD MOTOR

Note that the castle nut wrench is not included with the tool set that comes with the outboard motor. Contact your authorized TOHATSU dealer for additional tool information.

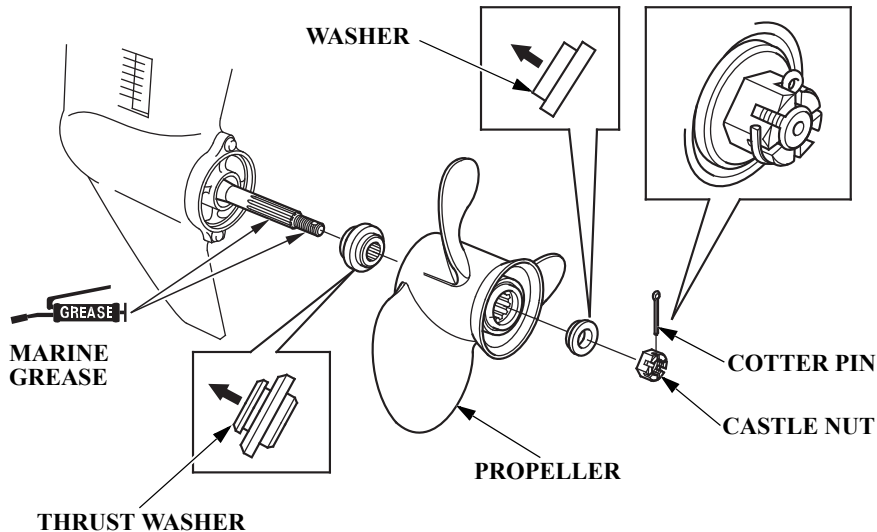

Inspect After Operating

1. Stop the engine and remove the engine cover (p. 88).
2. Confirm that there is no cooling water leakage from the engine.

CLEANING AND FLUSHING

Cleaning and Flushing

After each use in salt water or dirty water, thoroughly clean and rinse the outboard motor with fresh water.

Touch up any damaged paint, and coat areas that may rust with corrosion inhibitor, or equivalent. Lubricate controls with a silicone spray lubricant.

NOTICE

Do not apply water or corrosion inhibitor directly to the electrical components under the engine cover, such as the AC generator, the AC generator belt, or timing belt. If water or corrosion inhibitor penetrates these components, they may be damaged. Before applying a corrosion inhibitor, cover the AC generator and belt with a protective material to prevent damage.

Cleaning

Wash the outside of the outboard motor with clean, fresh water, and flush the cooling system as follows.

Flushing With a Garden Hose

NOTICE

Do not run the engine when flushing the outboard motor with a garden hose or the outboard motor may be damaged.

For safety, remove the emergency stop switch clip so the engine cannot be started while you are standing near the propeller.

1. Disconnect the fuel hose connector from the outboard motor.
2. Tilt down the outboard motor.

FLUSH PORT CONNECTOR

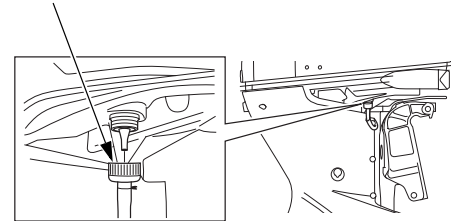

3. Disconnect the flush port connector.

CLEANING AND FLUSHING

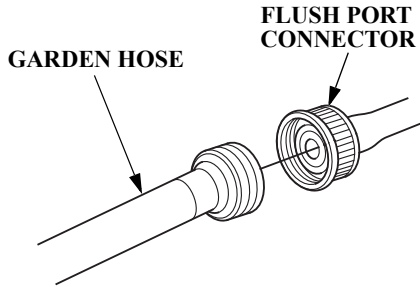

4. Screw the flush port connector onto the garden hose.

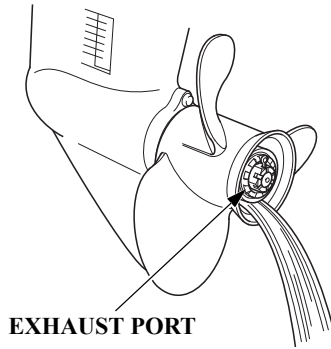

5. Turn on the fresh water supply and flush the outboard motor for at least 10 minutes.
6. After flushing, disconnect the garden hose and reconnect the flush port connector.
7. Tilt up the outboard motor and move the tilt lock lever to the LOCK position.

Fuel

NOTICE

Depending on the region where you operate your outboard, fuel formulations may deteriorate and oxidize rapidly. Fuel deterioration and oxidation can occur in as little as 15 days and may cause damage to the fuel system. Please check with your servicing dealer for local storage recommendations.

Gasoline will oxidize and deteriorate in storage. Old gasoline will cause hard starting, and it leaves gum deposits that clog the fuel system. If the gasoline in your fuel tank and vapor separator deteriorates during storage, you may need to have the vapor separator and other fuel system components serviced or replaced.

The length of time that gasoline can be left in your fuel tank and vapor separator without causing functional problems will vary with such factors as gasoline blend, your storage

temperatures, and whether the fuel tank is partially or completely filled. The air in a partially filled fuel tank promotes fuel deterioration. Very warm storage temperatures accelerate fuel deterioration. Fuel deterioration problems may occur in less than 15 days, if the gasoline was not fresh when you filled the fuel tank.

You can avoid fuel deterioration problems by draining all the fuel from the fuel tank and vapor separator.

STORAGE

Draining the Fuel System

You can avoid fuel deterioration problems by draining the fuel tank and vapor separator.

Drain the fuel into an approved fuel container.

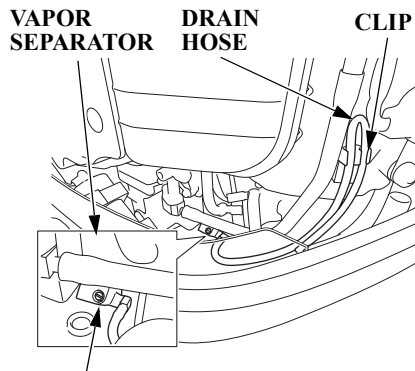

DRAIN SCREW

1. Unhook the drain hose from the clip on the lower left of the head cover.
2. Set the end of the hose toward the outside of the engine undercase and below the level of the vapor separator drain screw.

3. Loosen the vapor separator drain screw by using a commercially available flat tip screwdriver.

⚠ WARNING

Gasoline is highly flammable and explosive.

You can be burned or seriously injured when handling fuel.

- Stop the engine and let it cool before handling fuel.
- Keep heat, sparks, and flame away.
- Handle fuel only outdoors.
- Keep away from your vehicle.
- Wipe up spills immediately.

4. With the outboard motor turned to the starboard side, tilt the outboard motor up. Keep the end of the drain hose below the level of the vapor separator drain screw, and watch for the fuel to start flowing out the drain hose.
5. After the fuel starts flowing out the drain hose, tilt the outboard motor down and allow the vapor separator to finish draining.
6. After draining thoroughly, tighten the drain screw securely.
7. Clip the drain hose on the head cover.
8. Drain the fuel tank into an approved gasoline container.

Engine Oil

1. Change the engine oil and the oil filter (p. 91 – 93).
2. Remove the spark plugs (p. 95), and remove the emergency stop switch clip from the emergency stop switch.
3. Pour 1 – 2 teaspoons (5 – 10 cm³) of clean engine oil into each cylinder.
4. Rotate the engine a few revolutions to distribute the oil in the cylinders.
5. Reinstall the spark plugs (p. 97).

STORAGE

HOISTING THE OUTBOARD MOTOR

Front

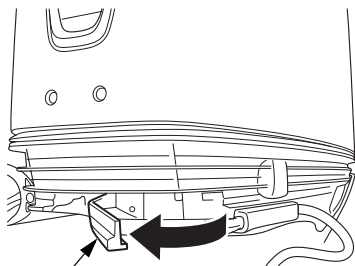

ENGINE COVER LATCH

Side

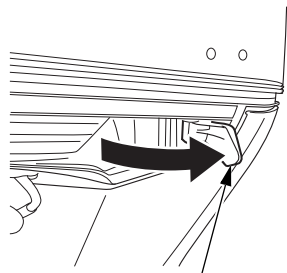

ENGINE COVER LATCH (each side)

1. Unlock and remove the engine cover (p. 88).

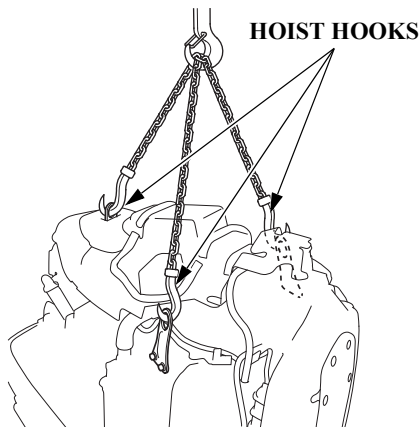

2. Attach the hoist hooks to the engine hangers.
3. Disconnect the outboard motor from the boat, hoist the outboard motor, and move it to the storage area.
4. After the outboard motor is placed in storage and disconnected from the hoist, install the engine cover (p. 88).

STORAGE PRECAUTIONS

Select a well-ventilated storage area. If possible, avoid storage areas with high humidity.

If storing a container of gasoline, store it away from any appliance that operates with a flame, such as a furnace, water heater, or clothes dryer. Also avoid any area with a spark producing electric motor, or where power tools are operated.

OUTBOARD MOTOR STAND

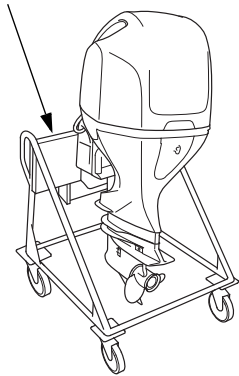

If the outboard motor will be removed from the boat for storage, we recommend storing it vertically by mounting it on a commercially available stand.

PROTECTOR

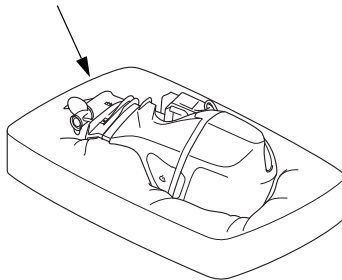

If it is necessary to store the outboard motor horizontally, drain the vapor separator (p. 110 – 111), and drain the engine oil (p. 91), before removing the outboard motor from the boat.

Rest the outboard motor on a cushion of protective material.

Cover the outboard motor to keep out dust. Do not use a plastic sheet as a dust cover. A nonporous cover will trap moisture, promoting rust and corrosion.

REMOVAL FROM STORAGE

Check your outboard motor as described in the *BEFORE OPERATION* chapter of this manual.

If the cylinders were coated with oil during storage preparation, the engine may smoke briefly at startup. This is normal.

TRANSPORTING

WITH OUTBOARD MOTOR INSTALLED ON BOAT

When trailering a boat with the outboard motor attached, always disconnect the fuel line from the fuel tank.

Use an outboard motor support bar to prevent the outboard motor from moving while trailering the boat. Refer to the manufacturer's instructions for using an outboard motor support bar.

The preferred method is to leave the engine in the normal running position, but if there is insufficient road clearance, you can tilt the outboard motor using a commercially available outboard motor support bar available through your dealer. Refer to the manufacturer's instructions for using an outboard motor support bar.

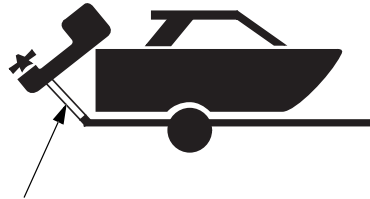

**OUTBOARD MOTOR SUPPORT BAR
(commercially available)**

WITH OUTBOARD MOTOR REMOVED FROM BOAT

Secure the outboard motor in either the vertical or horizontal position shown on p. 113.

TAKING CARE OF UNEXPECTED PROBLEMS

ENGINE WILL NOT START

Possible Cause	Correction
Clip not inserted in emergency stop switch.	Insert clip in emergency stop switch.
Control lever not in neutral position.	Shift to neutral.
Fast idle lever raised (side-mount type).	Leave fast idle lever OFF (p. 60).

TAKING CARE OF UNEXPECTED PROBLEMS

ENGINE WILL NOT START

Possible Cause	Correction
Out of fuel.	Refuel (p. 99).
Fuel hose not primed.	Squeeze priming bulb (p. 55).
Fuel filter or fuel tank filter clogged.	Replace fuel filters (p. 100).
Bad fuel; outboard motor stored without draining gasoline, or refueled with bad gasoline.	Drain fuel tank and vapor separator (p. 110 – 111). Refill with fresh gasoline (p. 99).

TAKING CARE OF UNEXPECTED PROBLEMS

ENGINE WILL NOT START

Possible Cause	Correction
Battery connections loose or corroded.	Clean and tighten battery connections.
Battery discharged.	Recharge battery.
Fuse(s) blown.	Replace fuse(s) (p. 120).
Spark plugs faulty, fouled, or improperly gapped.	Gap or replace spark plugs (p. 95).
Spark plugs wet with fuel (flooded engine).	Dry and reinstall spark plugs. Start engine with the throttle open.
Fuel system malfunction, fuel pump failure, ignition malfunction, stuck valves, starter malfunction, switch malfunction, or electrical problem in the starting circuit, etc.	Use starting procedure (p. 56, 59, 62, 64); if engine still will not start, then take outboard motor to an authorized TOHATSU dealer, or refer to the service manual.

TAKING CARE OF UNEXPECTED PROBLEMS

HARD STARTING OR STALLS AFTER STARTING

Possible Cause	Correction
Fast idle lever raised (side-mount type).	Leave fast idle lever OFF (p. 60).
Fuel hose not primed.	Squeeze priming bulb (p. 55).
Fuel filter or fuel tank clogged.	Replace fuel filters (p. 100).
Bad fuel; outboard motor stored without draining gasoline, or refueled with bad fuel.	Drain fuel tank and vapor separator (p. 110 – 111). Refill with fresh gasoline (p. 99).

TAKING CARE OF UNEXPECTED PROBLEMS

HARD STARTING OR STALLS AFTER STARTING

Possible Cause	Correction
Spark plugs faulty, fouled, or improperly gapped.	Gap or replace spark plugs (p. 95).
Fuel system malfunction, fuel pump failure, ignition malfunction, etc.	Take outboard motor to an authorized TOHATSU dealer, or refer to the service manual.

ENGINE OVERHEATS

Possible Cause	Correction
Water intake screens clogged.	Clean water intake screens.
Faulty thermostat or water pump.	Take outboard motor to an authorized TOHATSU dealer, or refer to the service manual.

TAKING CARE OF UNEXPECTED PROBLEMS

FUSES

Electric Starter Will Not Operate

The 7.5 A, 10 A, 15 A, 20 A, and 30 A main fuses protect the electric starter relay and related circuits.

The 30 A main fuse protects the ignition switch and related circuits. If this fuse blows, the engine will not start or run.

The 40 A fuse is in the power harness connected to the battery. If this fuse blows, the engine will not start or run.

Battery Will Not Charge

A 150 A ACG fuse protects the alternator circuit. If the ACG fuse blows, the engine will not charge the battery. Refer to *ACG Fuse* (p. 122).

Fuse Replacement

NOTICE

Disconnect the battery cable at the battery negative (-) terminal before replacing the fuse.

Failure to do so may cause a short circuit.

Main Fuse

1. Stop the engine.
2. Disconnect the battery.
3. Remove the engine cover (p. 88).
4. Open the junction box cover.

SPARE FUSES (7.5 A, 10 A, 15 A, 30 A) **MAIN FUSES** (7.5 A, 10 A, 15 A, 20 A, 30 A)

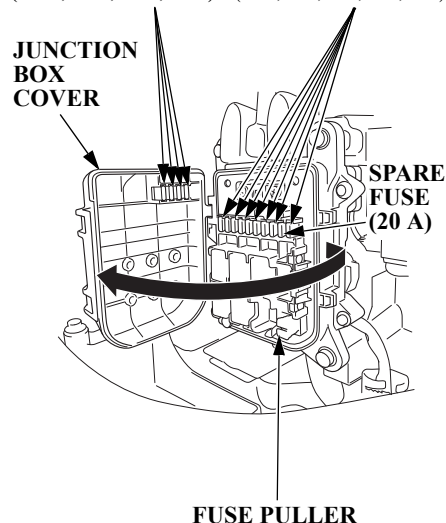

TAKING CARE OF UNEXPECTED PROBLEMS

Mechanical wire type

Fuse No.	Rating	Component(s) or Circuit(s) Protected
1	150 A	ACG, Battery
4	30 A	STARTER SOLENOID, AND RELAYS IN JUNCTION BOX
5	10 A	Power tilt relay, Warning buzzer, Indicator, Meter
8	10 A	Fuel pump (High pressure side)
9	15 A	Injector, ECU
10	10 A	DLC, Fuel pump (Low pressure side)
11	15 A	PTC

DBW type

Fuse No.	Rating	Component(s) or Circuit(s) Protected
1	150 A	ACG, Battery
2	20 A	GROUND (Main)
3	20 A	GROUND (Spare)
4	30 A	STARTER SOLENOID, AND RELAYS IN JUNCTION BOX
5	7.5 A	REMOTE CONTROL SYSTEM
6	30 A	SHIFT ACTUATOR
7	15 A	THROTTLE BODY
8	10 A	Fuel pump (High pressure side)
9	15 A	Injector, ECU
10	10 A	DLC, Fuel pump (Low pressure side)
11	15 A	PTC

5. Pull the old fuse out of the clip with the fuse puller supplied in the junction box.

6. Push a new fuse into the clips.

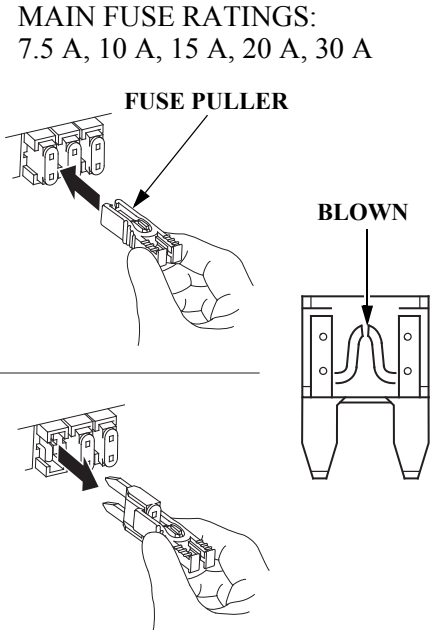

TAKING CARE OF UNEXPECTED PROBLEMS

7. Close the junction box cover and reinstall the engine cover (p. 88).

8. Reconnect the battery.

NOTICE

Never use a fuse with a rating greater than specified. Serious damage to the electrical system could result.

If a blown fuse is found, try to determine and correct the electrical problem that caused the blown fuse. An uncorrected electrical problem may cause the fuse to blow again.

If fuses continue to blow, take the outboard motor to an authorized TOHATSU dealer for inspection and service, or refer to the service manual.

ACG Fuse

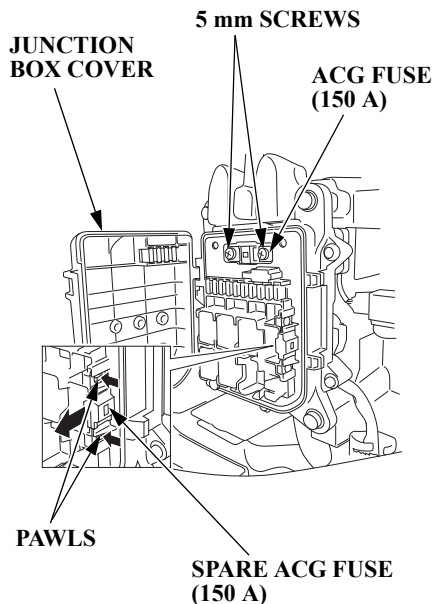

Replacement

1. Stop the engine.
 2. Disconnect the battery.
 3. Remove the engine cover (p. 88).
 4. Open the junction box cover.
 5. Remove the old fuse by removing two 5 mm screws.
 6. Install a new fuse by tightening two 5 mm screws.
- ACG FUSE: 150 A
7. After finishing replacement, close the junction box cover.
 8. Install the engine cover (p. 88).
 9. Reconnect the battery.

TAKING CARE OF UNEXPECTED PROBLEMS

A spare fuse is located on the junction box.

Push two pawls, then pull out the spare fuse.

Power Harness

1. Stop the engine.
2. Disconnect the battery cable and the power harness.
3. Open the fuse cover.
4. Pull the old fuse out of the clip with the fuse puller supplied in the fuse box.
5. Push a new fuse (40A) into the clip.
6. Close the fuse cover.

OIL PRESSURE INDICATOR TURNS OFF AND ENGINE SPEED IS LIMITED

Side-Mount Type

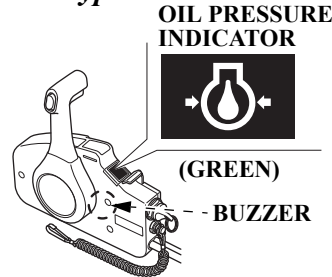

Flush-Mount, Top-Mount Type (Mechanical wire type)

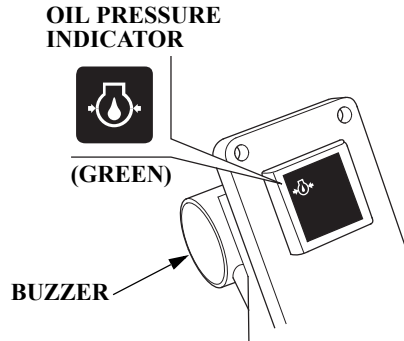

If oil pressure becomes low, the oil pressure indicator will turn off, and the engine protection system limits engine speed. If you are at cruising speed, engine speed will decrease automatically.

The oil pressure indicator is also equipped with a buzzer that sounds when the oil pressure indicator turns off.

Low oil pressure may be the result of a low engine oil level, or there may be a problem with the engine lubrication system.

TAKING CARE OF UNEXPECTED PROBLEMS

If the throttle is closed suddenly after full throttle operation, engine speed may drop below the specified idle rpm, and that could activate the engine protection system momentarily.

If low oil pressure activates the engine protection system, stop the engine, check the engine oil level (p. 89), and add oil if needed.

With the engine oil at the recommended level, restart the engine. If the lubrication system is OK, the oil pressure indicator should come on within 30 seconds, and the engine will respond normally to throttle control lever operation.

If the engine protection system remains activated after 30 seconds, return to the nearest boat landing, and have the outboard motor inspected by an authorized TOHATSU dealer.

OVERHEAT INDICATOR COMES ON AND ENGINE SPEED IS LIMITED

Side-Mount Type

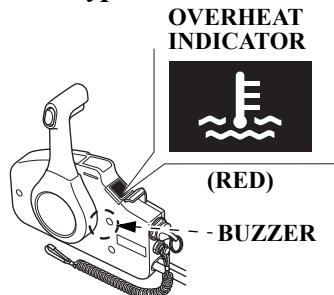

Flush-Mount, Top-Mount Type (Mechanical wire type)

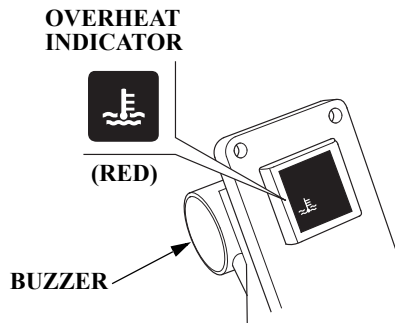

If the engine overheats, the overheat indicator will come on, and the engine will stop in 20 seconds after the engine protection system limits engine speed. If you are at cruising speed, engine speed will decrease automatically.

All types are equipped with a buzzer that sounds when the overheat indicator comes on.

Engine overheating may be the result of restricted water intake screens, or there may be a problem with the cooling system thermostat or water pump.

TAKING CARE OF UNEXPECTED PROBLEMS

If the engine is stopped after running at full throttle, and then restarted soon afterward, that could activate the engine protection system momentarily.

COOLING SYSTEM INDICATOR

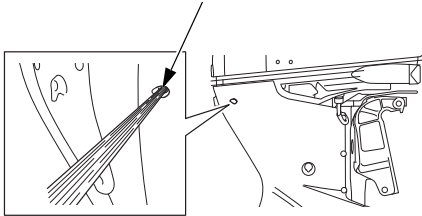

If overheating activates the engine protection system, idle the engine in neutral, and check the cooling system indicator.

If water is flowing from the cooling system indicator, continue idling for 30 seconds. If the cooling system is OK, the overheat indicator should go off within 30 seconds, and the engine will respond normally to throttle control lever operation.

If there is no water flowing from the cooling system indicator, stop the engine and check the discharge port first then tilt the outboard motor to inspect the water intake screens. If clogged, clean the water intake screens, return the outboard motor to the running position, restart the engine, and check the cooling system indicator again.

If there is still no water flowing from the cooling system indicator, or if the engine protection system remains activated after 30 seconds, return to the nearest boat landing, and have the outboard motor inspected by an authorized TOHATSU dealer.

WATER SEPARATOR BUZZER SOUNDS

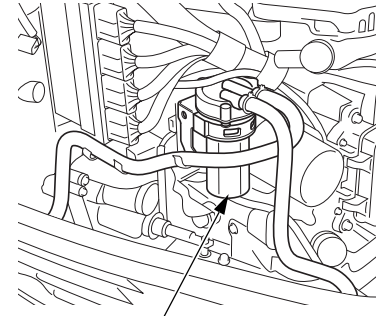

WATER SEPARATOR

When the water separator buzzer sounds (a rapid, repeating signal):

Check the water separator for water contamination. If water is present, stop the engine, and clean the water separator following the instructions on page 102, or consult with an authorized TOHATSU dealer.

TAKING CARE OF UNEXPECTED PROBLEMS

SUBMERGED OUTBOARD MOTOR

A submerged outboard motor must be serviced immediately after it is recovered from the water in order to minimize corrosion.

If there is a TOHATSU dealership nearby, take the outboard motor to the dealer immediately. If you are far from a dealership, proceed as follows:

1. Remove the engine cover (p. 88), and rinse the outboard motor with fresh water to remove salt water, sand, mud, etc.
2. Drain the vapor separator as described on p. 110 – 111.

3. Change the engine oil and oil filter as described on p. 91 – 93. If there was water in the engine crankcase, or if the used engine oil showed signs of water contamination, then a second engine oil change should be performed after running the engine for half an hour.
4. Remove the spark plugs (p. 95). Operate the starter to expel water from the engine's cylinder.

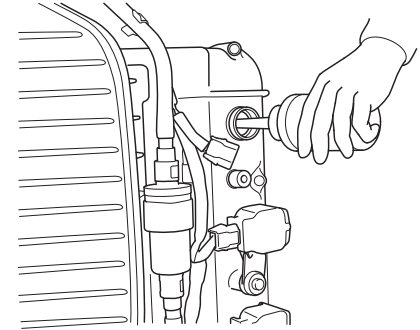

5. Put a teaspoon of engine oil into each spark plug hole to lubricate the inside of the cylinders. Reinstall the spark plugs.

If the engine was running when it submerged, there may be mechanical damage, such as bent connecting rods. If the engine binds when cranked, do not attempt to run the engine until it has been repaired.

TAKING CARE OF UNEXPECTED PROBLEMS

6. Attempt to start the engine. Be sure the water level is at least 2 inches (5 cm) above the antiventilation plate.

NOTICE

Running the outboard motor without sufficient cooling water will damage the water pump and overheat the engine.

If the engine fails to start, remove the spark plugs and dry them, then reinstall the spark plugs and attempt to start the engine again.

If the engine starts, and no mechanical damage is evident, continue to run the engine for a half hour or longer. Be sure the water level is at least 2 inches (5 cm) above the antiventilation plate to avoid overheating and water pump damage.

7. As soon as possible, take the outboard motor to an authorized TOHATSU dealer for inspection and service.

TAKING CARE OF UNEXPECTED PROBLEMS

Emergency Gear Shifting (for DBW type)

If the gear cannot be shifted, perform shift operation manually according to the following procedures and return to port at possible engine speed.

1. Set the remote control lever in the NEUTRAL position (p. 25-26).
2. Stop the engine (p. 68).
3. Remove the engine cover (p. 88).
4. Shift gear into neutral by inserting the phillips screwdriver with the grip of the tool kit (p. 84) into the hole of the shift actuator and moving the shaft.

SHIFT ACTUATOR HOLE

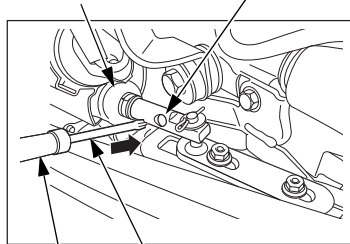

GRIP PHILLIPS SCREWDRIVER

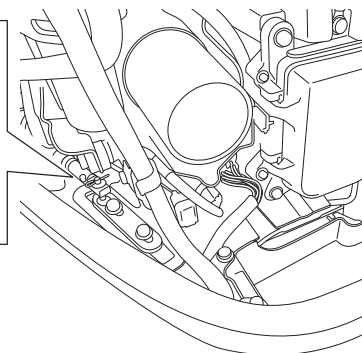

NEUTRAL REVERSE FORWARD

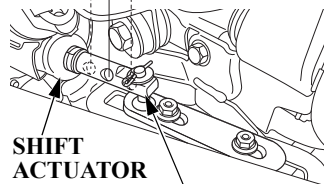

SHIFT ACTUATOR SHAFT
NEUTRAL position:

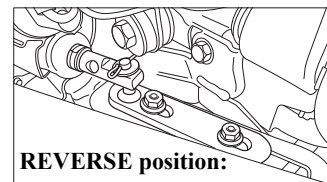
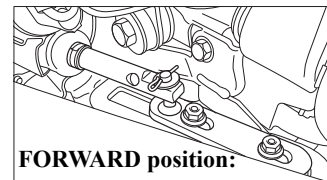

5. Start the engine (p. 56).
6. Shift gear into "F" (Forward) or "R" (Reverse) by moving the shaft of the shift actuator with the phillips screwdriver with the grip of the tool kit.

After returning to port, stop the engine and anchor the boat.

TECHNICAL INFORMATION

Serial Number Locations

Record the frame serial number, the engine serial number, and the date of purchase in the space provided on this page. You will need these numbers when ordering parts, and when making technical or warranty inquiries.

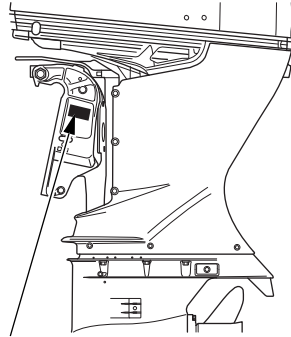

FRAME SERIAL NUMBER

The frame serial number is stamped on a plate attached on the left side of the stern bracket.

Frame serial number:

Date of purchase:

ENGINE SERIAL NUMBER

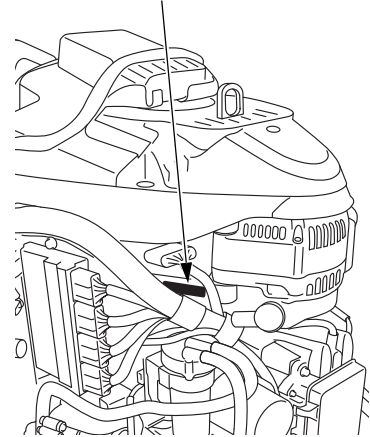

The engine serial number is stamped on the upper right side of the engine.

Engine serial number:

TECHNICAL INFORMATION

Battery

WARNING

The battery contains sulfuric acid (electrolyte), which is highly corrosive and poisonous.

Getting electrolyte in your eyes or on your skin can cause serious burns.

Wear protective clothing and eye protection when working near the battery.

**KEEP CHILDREN AWAY
FROM THE BATTERY.**

For complete information, refer to the battery manufacturer's instructions.

Minimum Requirements

12V – 92Ah/5HR (110Ah/20HR)
(CCA800)

NOTICE

- *Be careful to avoid connecting the battery in reverse polarity, as this will damage the battery-charging system in the outboard motor.*
- *Do not disconnect the battery cables while the engine is running. Disconnecting the cables while the engine is running will damage the outboard motor's electrical system.*
- *Battery cable extension: Extending the original battery cable will cause the battery voltage to drop due to the increased length of the cable and number of connections. This voltage drop may cause the buzzer to sound momentarily when engaging the starter motor and may prevent the engine from starting. If the engine starts and the buzzer sounds momentarily, there may be barely sufficient voltage reaching the engine.*

WARNING: Battery posts, terminals, and related accessories contain lead and lead compounds.
Wash your hands after handling.

Emission Control System Information

Source of Emissions

The combustion process produces carbon monoxide, oxides of nitrogen, and hydrocarbons. Control of hydrocarbons and oxides of nitrogen is very important because, under certain conditions, they react to form photochemical smog when subjected to sunlight. Carbon monoxide does not react in the same way, but it is toxic.

TOHATSU utilizes appropriate air/fuel ratios and other emissions control systems to reduce the emissions of carbon monoxide, oxides of nitrogen, and hydrocarbons.

Ignition Timing Control System

The system constantly adjusts the ignition timing, reducing the amount of HC, CO, and NOx produced.

PGM-FI System

The PGM-FI system uses sequential multiport fuel injection. It has three subsystems: Air Intake, Engine Control, and Fuel Control. The Engine Control Module (ECM) uses various sensors to determine how much air is going into the engine. It then controls how much fuel to inject under all operating conditions.

The U.S. and California Clean Air Acts

EPA and California regulations require all manufacturers to furnish written instructions describing the operation and maintenance of emission control systems.

The following instructions and procedures must be followed in order to keep the emissions from your TOHATSU engine within the emission standards.

TECHNICAL INFORMATION

Tampering and Altering

NOTICE

Tampering is a violation of Federal and California law.

Tampering with or altering the emission control system may increase emissions beyond the legal limit. Among those acts that constitute tampering are:

- Removal or alteration of any part of the intake, fuel, or exhaust systems.
- Alterations that would cause the engine to operate outside its design parameters.

Problems That May Affect Emissions

If you are aware of any of the following symptoms, have your engine inspected and repaired by your servicing dealer.

- Hard starting or stalling after starting
- Rough idle
- Misfiring or backfiring under load
- Afterburning (backfiring)
- Black exhaust smoke or high fuel consumption

Replacement Parts

The emission control systems on your TOHATSU engine were designed, built, and certified to conform with EPA and California emission regulations. We recommend the use of TOHATSU Genuine parts whenever you have maintenance done. These original-design replacement parts are manufactured to the same standards as the original parts, so you can be confident of their performance. The use of replacement parts that are not of the original design and quality may impair the effectiveness of your emission control system.

A manufacturer of an aftermarket part assumes the responsibility that the part will not adversely affect emission performance. The manufacturer or rebuilder of the part must certify that use of the part will not result in a failure of the engine to comply with emission regulations.

Maintenance

Follow the *MAINTENANCE SCHEDULE* on page. 85 – 86.

Remember that this schedule is based on the assumption that your machine will be used for its designed purpose. Sustained high-load operation, or use in unusual conditions, will require more frequent service.

TECHNICAL INFORMATION

Star Label

US, Puerto Rico, and US Virgin Islands

A Star label was applied to this outboard motor in accordance with the requirements of the California Air Resources Board.

The Star Label means Cleaner Marine Engine

This engine has been certified as a:



The Symbol for Cleaner Marine Engines:

Cleaner Air and Water - for healthier lifestyle and environment.

Better Fuel Economy - burns up to 30 - 40 percent less gas and oil than conventional carbureted two-stroke engines, saving money and resources.

Longer Emission Warranty - protects consumer for worry-free operation.



One Star Low Emission

The one-star label identifies engines that meet the Air Resources Board's Personal Watercraft and Outboard marine engine 2001 exhaust emission standards. Engines meeting these standards have 75% lower emissions than conventional carbureted two-stroke engines. These engines are equivalent to the U.S. EPA's 2006 standards for marine engines.



Two Stars Very Low Emission

The two-star label identifies engines that meet the Air Resources Board's Personal Watercraft and Outboard marine engine 2004 exhaust emission standards. Engines meeting these standards have 20% lower emissions than One Star-Low Emission engines.



Three Stars Ultra Low Emission

The three-star label identifies engines that meet the Air Resources Board's Personal Watercraft and Outboard marine engine 2008 exhaust emission standards or the Sterndrive and Inboard marine engine 2003-2008 exhaust emission standards. Engines meeting these standards have 65% lower emissions than One Star-Low Emission engines.



Four Stars Super Ultra Low Emission

The four-star label identifies engines that meet the Air Resources Board's Sterndrive and Inboard marine engine 2009 exhaust emission standards. Personal Watercraft and Outboard marine engines may also comply with these standards. Engines meeting these standards have 90% lower emissions than One Star-Low Emission engines.

Cleaner Watercraft - Get the Facts
1-800-END-SMOG
www.arb.ca.gov

TECHNICAL INFORMATION

Specifications

MODEL	BFT200D		
Description code	BBRJ		
Type	LRA	XRA	XCRA
Overall length	37.3 in (948 mm)		
Overall width	26.0 in (660 mm)		
Overall height	70.4 in (1,789 mm)	75.4 in (1,916 mm)	
Transom height (when transom angle at 12°)	20.0 in (508 mm)	25.0 in (635 mm)	
Dry mass [weight]*	615 lbs (279 kg)	626 lbs (284 kg)	628 lbs (285 kg)
Rated power	149.1 kW (200 HP)		
Full throttle range	5,000 – 6,000 rpm		
Engine type	4 stroke OHC 6-cylinder (V6)		
Displacement	218.6 cu-in (3,583 cm ³)		
Spark plug gap	0.039 – 0.043 in (1.0 – 1.1 mm)		
Steering control system	Outboard motor-mounted, remote control		
Starter system	Electric starter		
Ignition system	Full transistor battery		
Lubrication system	Trochoid pump pressure lubrication		

Specified oil	Engine: API standard (SG, SH, SJ or SL oil) SAE/FC-W 10W-30 Gear case: API standard (GL-4) SAE 90 Hypoid gear oil
Oil capacity	Engine: 8.0 US qt (7.6 L) without oil filter change 8.2 US qt (7.8 L) with oil filter change Gear case: 1.55 US qt (1.47 L)
CARB star label	ULTRA · LOW EMISSION
D.C. output	12 V – 60 A
Cooling system	Water cooling with thermostat
Exhaust system	Underwater exhaust
Spark plugs	ZFR6K-11E (NGK) IZFR6K-11E (NGK)
Fuel pump	Electromagnetic type
Fuel	Unleaded gasoline (86 pump octane or higher)
Gear change	Dog type (Forward-Neutral-Reverse)
Steering angle	30° right and left
Tilt up angle	68° (when Transom angle is 12°)
Trim angle	– 4° to 16° (when Transom angle is 12°)

* Without battery cable, with propeller

This TOHATSU motor is power rated in accordance with NMMA procedures and using the ICOMIA standard 28/23.

TECHNICAL INFORMATION

MODEL	BFT225D		
Description code	BBPJ		
Type	LRA	XRA	XCRA
Overall length	37.3 in (948 mm)		
Overall width	26.0 in (660 mm)		
Overall height	70.4 in (1,789 mm)	75.4 in (1,916 mm)	
Transom height (when transom angle at 12°)	20.0 in (508 mm)	25.0 in (635 mm)	
Dry mass [weight]*	619 lbs (281 kg)	631 lbs (286 kg)	633 lbs (287 kg)
Rated power	167.8 kW (225 HP)		
Full throttle range	5,000 – 6,000 rpm		
Engine type	4 stroke OHC 6-cylinder (V6)		
Displacement	218.6 cu-in (3,583 cm ³)		
Spark plug gap	0.039 – 0.043 in (1.0 – 1.1 mm)		
Steering control system	Outboard motor-mounted, remote control		
Starter system	Electric starter		
Ignition system	Full transistor battery		
Lubrication system	Trochoid pump pressure lubrication		

Specified oil	Engine: API standard (SG, SH, SJ or SL oil) SAE/FC-W 10W-30 Gear case: API standard (GL-4) SAE 90 Hypoid gear oil
Oil capacity	Engine: 8.0 US qt (7.6 L) without oil filter change 8.2 US qt (7.8 L) with oil filter change Gear case: 1.55 US qt (1.47 L)
CARB star label	ULTRA - LOW EMISSION
D.C. output	12 V – 60 A
Cooling system	Water cooling with thermostat
Exhaust system	Underwater exhaust
Spark plugs	ZFR6K-11E (NGK) IZFR6K-11E (NGK)
Fuel pump	Electromagnetic type
Fuel	Unleaded gasoline (86 pump octane or higher)
Gear change	Dog type (Forward-Neutral-Reverse)
Steering angle	30° right and left
Tilt up angle	68° (when Transom angle is 12°)
Trim angle	– 4° to 16° (when Transom angle is 12°)

* Without battery cable, with propeller

This TOHATSU motor is power rated in accordance with NMMA procedures and using the ICOMIA standard 28/23.

TECHNICAL INFORMATION

MODEL	BFT250D				
Description code	BBNJ				
Type	LRA	LDA	XRA	XDA XCRA	XCDA
Overall length	37.3 in (948 mm)				
Overall width	26.0 in (660 mm)				
Overall height	70.4 in (1,789 mm)		75.4 in (1,916 mm)		
Transom height (when transom angle at 12°)	20.0 in (508 mm)		25.0 in (635 mm)		
Dry mass [weight]*	619 lbs (281 kg)	622 lbs (282 kg)	631 lbs (286 kg)	633 lbs (287 kg)	635 lbs (288 kg)
Rated power	186.4 kW (250 HP)				
Full throttle range	5,300 – 6,300 rpm				
Engine type	4 stroke OHC 6-cylinder (V6)				
Displacement	218.6 cu-in (3,583 cm ³)				
Spark plug gap	0.039 – 0.043 in (1.0 – 1.1 mm)				
Steering control system	Outboard motor-mounted, remote control				
Starter system	Electric starter				
Ignition system	Full transistor battery				
Lubrication system	Trochoid pump pressure lubrication				

Specified oil	Engine: API standard (SG, SH, SJ or SL oil) SAE/FC-W 10W-30 Gear case: API standard (GL-4) SAE 90 Hypoid gear oil
Oil capacity	Engine: 8.0 US qt (7.6 L) without oil filter change 8.2 US qt (7.8 L) with oil filter change Gear case: 1.55 US qt (1.47 L)
CARB star label	ULTRA - LOW EMISSION
D.C. output	12 V – 60 A
Cooling system	Water cooling with thermostat
Exhaust system	Underwater exhaust
Spark plugs	ZFR6K-11E (NGK) IZFR6K-11E (NGK)
Fuel pump	Electromagnetic type
Fuel	Unleaded gasoline (86 pump octane or higher)
Gear change	Dog type (Forward-Neutral-Reverse)
Steering angle	30° right and left
Tilt up angle	68° (when Transom angle is 12°)
Trim angle	– 4° to 16° (when Transom angle is 12°)

* Without battery cable, with propeller

This TOHATSU motor is power rated in accordance with NMMA procedures and using the ICOMIA standard 28/23.

TECHNICAL INFORMATION

MODEL	BFT250D		
Description code	BBNJ		
Type	URA	UDA UCRA	UCDA
Overall length	37.3 in (948 mm)		
Overall width	26.0 in (660 mm)		
Overall height	80.4 in (2,043 mm)		
Transom height (when transom angle at 12°)	30.0 in (762 mm)		
Dry mass [weight]*	642 lbs (291 kg)	644 lbs (292 kg)	646 lbs (293 kg)
Rated power	186.4 kW (250 HP)		
Full throttle range	5,300 – 6,300 rpm		
Engine type	4 stroke OHC 6-cylinder (V6)		
Displacement	218.6 cu-in (3,583 cm ³)		
Spark plug gap	0.039 – 0.043 in (1.0 – 1.1 mm)		
Steering control system	Outboard motor-mounted, remote control		
Starter system	Electric starter		
Ignition system	Full transistor battery		
Lubrication system	Trochoid pump pressure lubrication		

Specified oil	Engine: API standard (SG, SH, SJ or SL oil) SAE/FC-W 10W-30 Gear case: API standard (GL-4) SAE 90 Hypoid gear oil
Oil capacity	Engine: 8.0 US qt (7.6 L) without oil filter change 8.2 US qt (7.8 L) with oil filter change Gear case: 1.55 US qt (1.47 L)
CARB star label	ULTRA - LOW EMISSION
D.C. output	12 V – 60 A
Cooling system	Water cooling with thermostat
Exhaust system	Underwater exhaust
Spark plugs	ZFR6K-11E (NGK) IZFR6K-11E (NGK)
Fuel pump	Electromagnetic type
Fuel	Unleaded gasoline (86 pump octane or higher)
Gear change	Dog type (Forward-Neutral-Reverse)
Steering angle	30° right and left
Tilt up angle	68° (when Transom angle is 12°)
Trim angle	– 4° to 16° (when Transom angle is 12°)

* Without battery cable, with propeller

This TOHATSU motor is power rated in accordance with NMMA procedures and using the ICOMIA standard 28/23.

TECHNICAL INFORMATION

BFT200D Tune up

Spark plug gap	0.039 – 0.043 in (1.0 – 1.1 mm)	See page 96
Idle speed	650 ± 50 rpm	See service manual
Valve clearance (cold)	Intake: 0.22 ± 0.02 mm Exhaust: 0.30 ± 0.02 mm	See service manual
Other specifications	No other adjustments needed	

BFT225D Tune up

Spark plug gap	0.039 – 0.043 in (1.0 – 1.1 mm)	See page 96
Idle speed	650 ± 50 rpm	See service manual
Valve clearance (cold)	Intake: 0.22 ± 0.02 mm Exhaust: 0.30 ± 0.02 mm	See service manual
Other specifications	No other adjustments needed	

BFT250D Tune up

Spark plug gap	0.039 – 0.043 in (1.0 – 1.1 mm)	See page 96
Idle speed	650 ± 50 rpm	See service manual
Valve clearance (cold)	Intake: 0.22 ± 0.02 mm Exhaust: 0.30 ± 0.02 mm	See service manual
Other specifications	No other adjustments needed	

CONSUMER INFORMATION

Emission Control System Warranty

Your new Tohatsu outboard engine complies with both the U.S. EPA and State of California emission regulations. Tohatsu Corporation provides the same emission warranty coverage for outboard engines sold in all 50 states. In all areas of the United States your outboard engine must be designed, built, and equipped to meet the U.S. EPA and California Air Resources Board emissions standard for spark ignited marine engines.

CALIFORNIA EMISSIONS CONTROL SYSTEM WARRANTY STATEMENT YOUR WARRANTY RIGHTS AND OBLIGATIONS

The California Air Resources Board (CARB) and Tohatsu Corporation are pleased to explain the emission control system warranty on your 2020 Tohatsu outboard engine. In California, new outboard engines must be designed, built, and equipped to meet the state's stringent anti-smog standards.

Tohatsu Corporation must warrant the emission control system on your outboard engine for the periods of time listed below provided there has been no abuse, neglect, or improper maintenance of your outboard engine.

Your emission control system may include parts such as the carburetor or fuel injection system, the ignition system, catalytic converter, canisters, clamps, filters, fuel caps, fuel lines, fuel tanks, valves, and vapor hoses. Also included may be hoses, belts, connectors, and other emission-related assemblies.

Where a warrantable condition exists, Tohatsu Corporation will repair your outboard engine at no cost to you including diagnosis, parts, and labor.

CONSUMER INFORMATION

MANUFACTURER'S WARRANTY COVERAGE:

Select emission control parts from model year 2010 and later outboard engines are warranted for five years or 250 hours of use, whichever first occurs; or the length of the Tohatsu Limited Warranty Information, whichever is longer. The evaporative emissions control system from model year 2010 and later outboard engines are warranted for two years with no limit on hours of use, or the length of the Tohatsu Limited Warranty Information, whichever is longer, from the date of delivery to the retail purchaser. However, warranty coverage based on the hourly period is only permitted for engines equipped with hour meters as defined in § 2441 (a)(13)* or their equivalent. If any emission-related part on your engine is defective under warranty, the part will be repaired or replaced by Tohatsu Corporation. See the Emission Control System Warranty Parts table on page 145 for parts description.

* California Code of Regulations

OWNER'S WARRANTY RESPONSIBILITIES:

As the outboard engine owner, you are responsible for the performance of the required maintenance listed in your owner's manual.

Tohatsu Corporation recommends that you retain all receipts covering maintenance on your outboard engine, but Tohatsu Corporation cannot deny warranty solely for the lack of receipts or your failure to ensure the performance of all scheduled maintenance.

As the outboard engine owner, you should, however, be aware that Tohatsu Corporation may deny you warranty coverage if your outboard engine or a part has failed due to abuse, neglect, improper maintenance, or unapproved modifications.

You are responsible for presenting your outboard engine to a Tohatsu authorized dealer as soon as a problem exists. The warranty repairs will be completed in a reasonable amount of time, not to exceed 30 days.

If you have any questions regarding your warranty rights and responsibilities, you should contact

Tohatsu America Corporation
670 South Freeport Parkway
Suite 120 Coppell, TX 75019
Telephone: (214) (496) 771-3740

WARRANTY COVERAGE:

See Manufacturer's Warranty Coverage above for warranty coverage terms. This warranty is transferred to each subsequent purchaser for the duration of the warranty period. Warranty repairs will be made without charge for diagnosis, parts, and labor. All defective parts replaced under this warranty become the property of Tohatsu Corporation. A list of warranty parts is on page 145. Normal maintenance items, such as spark plugs and filters, that are on the warranted parts list are warranted up to their required replacement interval only. Tohatsu Corporation is also liable for damages to other engine components caused by a failure of any warranted part during the warranty period.

Only Tohatsu Corporation approved replacement parts will be used in the performance of any warranty repairs, and they will be provided without charge to the owner. You may use any replacement part as defined in § 1900 (b)(20)* in the performance of any maintenance or repairs. Tohatsu cannot deny coverage under the emission warranty solely for use of non-Tohatsu replacement parts or service performed at a location other than an authorized Tohatsu dealership; however, use of a part that is not functionally identical to the original equipment part in any respect that may in any way affect emissions (including

durability) could result in denial of coverage.

If a non-Tohatsu replacement part is used in the repair or maintenance of your engine, and an authorized Tohatsu dealer determines it causes the failure of a warranted part, your warranty claim may be denied. If the part in question is not related to the reason that your engine requires repair, your claim will not be denied.

* California Code of Regulations

TO OBTAIN WARRANTY SERVICE:

You must take your Tohatsu outboard engine, along with your warranty registration card or other proof of original purchase date, at your expense, to any Tohatsu dealer that is authorized by Tohatsu Corporation to sell and service that Tohatsu product during its normal business hours. Claims for repair or adjustment found to be caused solely by defects in material or workmanship will not be denied because the engine was not properly maintained and used. If you are unable to obtain warranty service, or are dissatisfied with the warranty service you received, contact the owner of the dealership involved. Normally this should resolve your problem. However, if you require further assistance, write or call Tohatsu Corporation.

CONSUMER INFORMATION

EXCLUSIONS:

Failures other than those resulting from defects in material or workmanship are not covered by this warranty. This warranty does not extend to emission control systems or parts which are affected or damaged by owner abuse, neglect, improper maintenance, misuse, misfueling, improper storage, and/or collision, the incorporation of, or use of, unsuitable attachments, or the unauthorized alteration of any part.

This warranty does not cover replacement of expendable maintenance items made in connection with required maintenance service after the items first scheduled replacement as listed in the maintenance section of the product (outboard motor) owner's manual, such as: spark plugs and filters.

DISCLAIMER OF CONSEQUENTIAL DAMAGE AND LIMITATION OF IMPLIED WARRANTIES:

Tohatsu Corporation disclaims any responsibility for incidental or consequential damages such as loss of time or the use of outboard engine, or any commercial loss due to the failure of the equipment; and any implied warranties are limited to the duration of this written warranty. This warranty is applicable only where the California or U.S. EPA emissions control system warranty regulation is in effect.

CONSUMER INFORMATION

EMISSION CONTROL SYSTEM WARRANTY PARTS:

SYSTEMS COVERED BY THIS WARRANTY:	PARTS DESCRIPTION:	LENGTH OF WARRANTY:
Evaporative	Portable fuel tank, Outboard internal fuel tank, Fuel cap, Fuel hoses, Primer bulb, Fuel hose joint, Vapor separator, and Carbon canister, All other parts not listed that may affect the evaporative emissions control system	Two years, no limit on hours of use; or the length of the Tohatsu Limited Warranty Information, whichever is longer.
Fuel Metering	Carburetor assembly, Throttle body, Fuel injector, Fuel pump, Fuel pressure regulator, Throttle position sensor, Intake air temperature sensor, Engine temperature sensor, Manifold absolute pressure sensor, Idle air control valve, Barometric pressure sensor, Fuel line solenoid valve, Intake manifold, Intake valves, and Oxygen sensor or Air fuel ratio sensor	Five years or 250 hours of use, whichever first occurs; or the length of the Tohatsu Limited Warranty Information, whichever is longer.
Air Induction	Air intake duct, Intake manifold tuning valve (Intake air bypass control valve)	
Ignition	Flywheel magneto, Ignition pulse generator, Ignition coil assembly, Ignition control module, Engine control module, Crankshaft position sensor, Spark plug cap, Spark plug*, Knock sensor, and Camshaft position sensor	
Lubrication System	Oil pump and internal parts	
Crankcase Emission Control	Crankcase breather tube, Positive crankcase ventilation valve, Oil filler cap	
Exhaust	Exhaust manifold and Exhaust valves	
Valve Control System	Rocker arm oil control valve	
Miscellaneous Parts	Tubing, fittings, seals, gaskets, and clamps associated with these listed systems.	
* Covered up to the first required replacement only. See the <i>Maintenance Schedule</i> on page 85 and 86.		

INDEX

Alternator (ACG) Indicator	47	Electric Starter Will Not Operate.....	120
Anodes	50	Emergency Stop Switch Clip and Emergency Stop Switch	
Replacement	104	Flush-Mount Type (Mechanical wire type).....	33
ARE YOU READY TO GET UNDERWAY?	52	Flush-Mount Type/Top-Mount Type (DBW type)....	24
Battery	130	Side-Mount Type	31
Will Not Charge	120	Top-Mount Type (Mechanical wire type)	37
BEFORE OPERATION	52	Emission Control System Information.....	131
BREAK-IN PROCEDURE	54	Emission Control System Warranty.....	141
CLEANING AND FLUSHING	107	Engine	
Common Controls	40	Cover	
COMPONENT AND CONTROL LOCATIONS	12	Latch	43
CONSUMER INFORMATION	141	REMOVAL AND INSTALLATION	88
CONTROL AND FEATURE IDENTIFICATION		Oil	
CODES	10	Change	91
CONTROLS	21	Filter Change	92
CONTROLS AND FEATURES	10	Level Checker.....	89
Cooling System Indicator	49	Recommendations.....	93
CRUISING	75	ENGINE OVERHEATS.....	119
		ENGINE WILL NOT START	115

Fast Idle Button		Ignition Switch	
Flush-Mount Type	36	Flush-Mount Type (Mechanical wire type)	33
Top-Mount Type	39	Flush-Mount Type/Top-Mount Type (DBW type)....	21
Fast Idle Lever	33	Side-Mount Type	30
Fuel		Top-Mount Type (Mechanical wire type)	37
Filter Inspection and Replacement	100	IMPORTANT SAFETY INFORMATION	7
PRIMING	55	INDICATORS	47
Priming Bulb	51	INFREQUENT OR OCCASIONAL USE.....	55
RECOMMENDATIONS	100	Inspect After Operating.....	106
Function Switches	27, 28	INSTRUMENTS.....	44
FUSES		IS YOUR OUTBOARD MOTOR READY TO GO? ...	52
Replacement	120		
GEARSHIFT AND THROTTLE OPERATION	72	Lubrication Points	94
Gearshift/Throttle Control Lever		MAINTENANCE SAFETY	83
Flush-Mount Type (DBW type)	25	MAINTENANCE SCHEDULE	85
Flush-Mount Type (Mechanical wire type).....	35	Malfunction Indicator	48
Side-Mount Type.....	31	MANUAL RELIEF VALVE.....	42, 88
Top-Mount Type (DBW type)	26	MOORING, BEACHING, LAUNCHING	80
Top-Mount Type (Mechanical wire type)	38	MULTIPLE OUTBOARD MOTORS	81
HARD STARTING OR STALLS AFTER		NMEA 2000 [®] Interface Coupler	44
STARTING	118		
HOISTING THE OUTBOARD MOTOR.....	112		

INDEX

Oil Pressure Indicator	48	SAFE OPERATING PRECAUTIONS.....	54
OIL PRESSURE INDICATOR TURNS OFF AND ENGINE SPEED IS LIMITED	123	SAFETY LABEL LOCATION	9
Operating Hour Notification System.....	45	Serial Number Locations	129
OPERATION	54	SERVICING YOUR OUTBOARD MOTOR	82
OTHER FEATURES.....	50	SHALLOW WATER OPERATION	79
OUTBOARD MOTOR SAFETY	7	SPARE EMERGENCY STOP SWITCH CLIP	84
Overheat Indicator	49	Spark Plug Service.....	95
OVERHEAT INDICATOR COMES ON AND ENGINE SPEED IS LIMITED	124	Specifications	136
Power Switch.....	22	Star Label	134
Power Tilt Switch	42	STARTING THE ENGINE	56
Power Trim/Tilt Switch.....	40	Flush-Mount Type (Mechanical wire type).....	62
Propeller Replacement.....	105	Flush-Mount Type/Top-Mount Type (DBW type)....	56
REFUELING.....	99	Side-Mount Type	59
REMOVAL FROM STORAGE.....	113	Top-Mount Type (Mechanical wire type)	64
Rev Limiter.....	50	Start/Stop Switch	23
		STEERING	74
		STOPPING THE ENGINE.....	67
		Emergency Engine Stopping	67
		Normal Engine Stopping	68, 70
		STORAGE	109
		Engine oil.....	111
		Fuel	109
		STORAGE PRECAUTIONS.....	112
		SUBMERGED OUTBOARD MOTOR	126

Tachometer (optional equipment)	44
TAKING CARE OF UNEXPECTED PROBLEMS....	115
TECHNICAL INFORMATION	129
THE IMPORTANCE OF MAINTENANCE.....	82
Tilt Lock Lever.....	43
TOOL KIT and OWNER'S MANUAL	84
TRANSPORTING.....	114
WITH OUTBOARD MOTOR INSTALLED	
ON BOAT	114
WITH OUTBOARD MOTOR REMOVED	
FROM BOAT.....	114
Trim Meter (optional equipment).....	44
Trim Tab.....	43
TRIM TAB ADJUSTMENT	87
WATER SEPARATOR BUZZER SOUNDS	125

MEMO

MEMO

MEMO

© 2020 Honda motor Co., Ltd. – All Rights Reserved
PGM-FI is a trademark of Honda Motor Co., Ltd.
registered in Japan and other countries.

OWNER'S MANUAL



BFT200D
BFT225D
BFT250D

TOHATSU CORPORATION

5-4, Azusawa 3-Chome, Itabashi-Ku
Tokyo 174-0051, Japan

Tel:+81-3- 3966-3117 Fax:+81-3-3966-2951

www.tohatsu.com

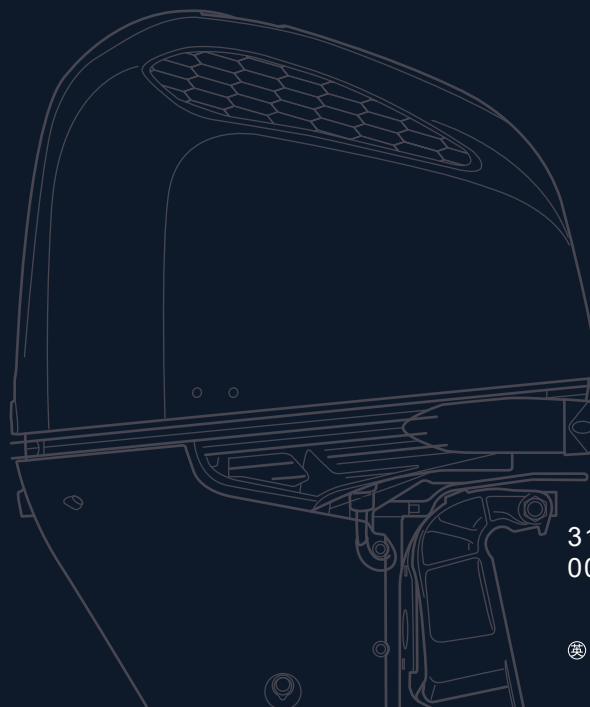

31ZVLT03
00X31-ZVL-T030

XXX.XXXX.XX

🇯🇵 PRINTED IN JAPAN