

55.70

TOHATSU



OUTBOARD MOTOR

OPERATING MANUAL
FOR M55B
M70A

TOHATSU CORPORATION

Copyright © 2007 Tohatsu Corporation. All rights reserved. No part of this manual may be reproduced or transmitted in any form or by any means without the express written permission of Tohatsu Corporation.

FOREWORD

Thank you for choosing a TOHATSU OUTBOARD MOTOR. This manual describes its workings and its main features. Before using the motor study these instructions and get to know what a fine engine it is. Like any other piece of machinery it requires careful and knowledgeable attention, and in return it will give you excellent service over the years.

This manual is applicable to model M55B and M70A remote control type (P) and bar handle type (F). Where it applies only to one of these types, the type (P) or (F) will be indicated at the end of the paragraph.

Note: Our policy is one of continuous product improvement so we reserve the right to incorporate changes without prior notice.

 **TOHATSU CORPORATION**

CONTENTS

	PAGE
1. SPECIFICATIONS	2
2. MAIN PARTS	4
3. MOUNTING THE OUTBOARD MOTOR	5
4. THE METHOD OF CONNECTING THE REMOTE CONTROL CABLES	8
5. THE METHOD OF WIRING THE TACHOMETER	10
6. MOUNTING THE BATTERY	11
7. PREPARATIONS BEFORE OPERATION AND PRECAUTIONS	12
8. STARTING THE MOTOR	13
9. OPERATION	17
10. INSPECTION AND REPAIRS	24
11. PROCEDURE IF MOTOR FALLS INTO WATER	27
12. LAYING UP THE ENGINE	27
13. SEASONAL STORAGE OF THE OUTBOARD MOTOR	28
14. DAILY INSPECTION	29
15. POWER TRIM AND TILT (OPTIONAL)	31
16. PERIODICAL INSPECTION	36
17. CARE OF BATTERY	37
18. ACCESSORIES SUPPLIED	38
19. OPTIONAL EQUIPMENT	39
20. WIRING DIAGRAMS	41

1. SPECIFICATIONS

MODEL	M55 B	M70A
Overall length	705 mm (P) 1,305 mm (F)	
Overall width	355 mm	
Overall height	1,317 mm	
Weight	86 kg	94 kg
Engine type	2WT81A	2WT86A
Piston displacement	749 cc	845 cc
Power output	55 PS/5,250 rpm	70 PS/5,500 rpm
Lubrication	Gasoline/oil mixture 50:1	
Cooling method	Water cooling (Rotary rubber impeller)	
Cooling water temperature adjustment	Thermostat	
Starting	Electric starter Rope (Emergency)	
Ignition	C.D. Ignition	
Lighting coil	12 V - 80 W	
Spark plug	NGK B8HS10 or CHAMPION L78C10	
Carburetor	Cross-shaft butterfly valve type	
Engine rotation	Clockwise	

MODEL	M55B	M70A
Recommended operating range	4,500 ~ 5,500 rpm	5,000 ~ 5,500 rpm
Fuel consumption at maximum speed	Approx. 24 ℓ/hr	
Gear reduction ratio	12 : 23	
Propeller (Nos. of blades x dia. x pitch)	3 x 292 x 254 (10") 3 x 292 x 279 (11") 3 x 295 x 305 (12") 3 x 292 x 330 (13") (Standard propeller for M55B) 3 x 289 x 356 (14") (Standard propeller for M70A) 3 x 280 x 381 (15") 3 x 273 x 417 (16.5") 3 x 276 x 447 (17.5")	
Speed control	Remote control (P), Hand grip (F)	
Clutch	Dog clutch (FORWARD, NEUTRAL, REVERSE)	
Operating method	Remote control (P), Bar handle (F)	
Fuel tank capacity	24ℓ	

(P) means the remote control operation type.

(F) means the bar handle operation type.

2. MAIN PARTS

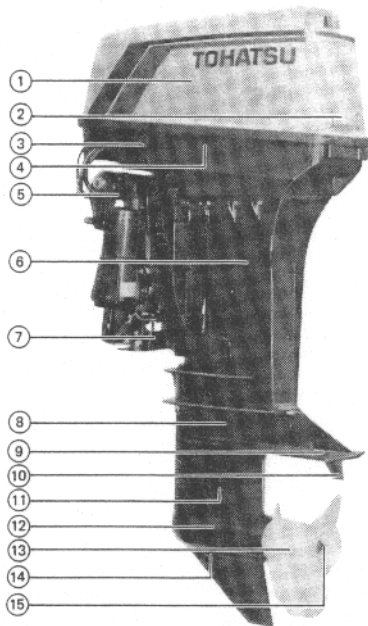

M70AEP

- (1) Upper Motor Cover
- (2) Hook Lever
- (3) Fuel Connector B
- (4) Lower Motor Cover
- (5) Stern Bracket
- (6) Drive Shaft Housing
- (7) Swivel Bracket
- (8) Oil Plug
- (9) Anti-Cavitation Plate
- (10) Trim Tab
- (11) Water Strainer
- (12) Gear Case
- (13) Propeller
- (14) Oil Plug
- (15) Propeller Nut
- (16) Fuel Tank (24 Lit.)
- (17) Tank Cap
- (18) Primer Valve
- (19) Fuel Cock
- (20) Fuel Gauge
- (21) Fuel Connector A

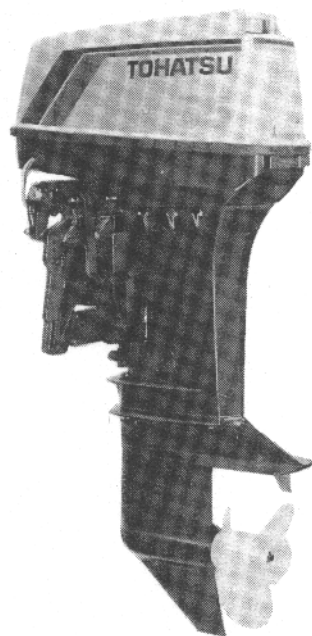
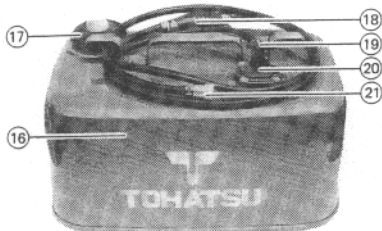

M55BEP

3. MOUNTING THE OUTBOARD MOTOR

(1) Mounting position

Mount the motor at the center of the transom board by placing packing of cushion or a protecting plate between the motor and the board. (Fig. 1 and 3)

(2) Mounting height

Select such an outboard motor so that the gap between its anti-cavitation plate and the bottom of the boat is between 10 to 30mm when mounted. (Fig. 2)
The mounting height of the motor can be adjusted within a margin of 17mm depend on the mounting position of the stern bracket.

(3) Mounting the stern bracket

When the mounting position has been determined, drill holes in the transom board at 4 places for the stern bracket bolts and install the bracket on the transom board with attached bolts and nuts (M12 x 100mm). When holes are drilled in advance, refer to the dimension drawings. (Fig. 3, 4)

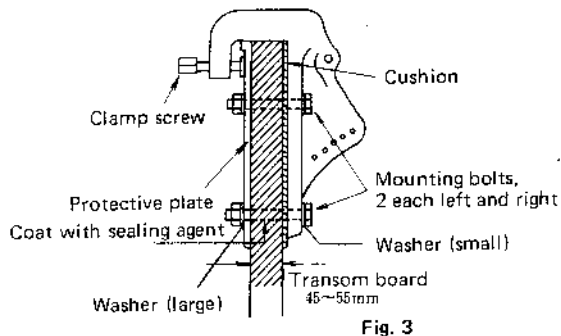
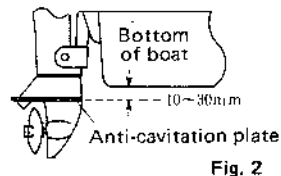
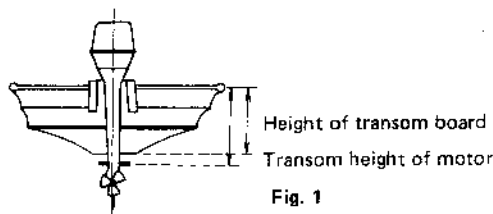

Note: When fastening bolts, apply sealing agent between the transom board and bolts to prevent water entering. It is very dangerous to operate an out-board motor which is held by clamp screws alone. Be sure to bolt the motor securely with the attached bolts and nuts.

(4) Adjustment of bracket (EP, EF type)

a. Mounting angle

Adjust the angle of the motor so that its cavitation plate is parallel to the water surface when the boat is running at its maximum speed. (Photo. 1, 2)

b. Dimension drawing of bracket mounting holes (Fig. 4)

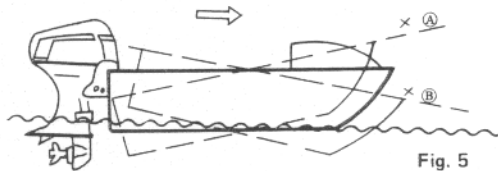

Fig. 5

For EPT and EFT types, please refer to page 31 and after.

- (A) If the bow tends to move up and shake or the propeller tends to cause cavitation, move the trust rod to a lower position. (Photo. 1)
- (B) If the bow tends to sink and get waves when running, move the thrust rod to a higher position. (Photo. 2)

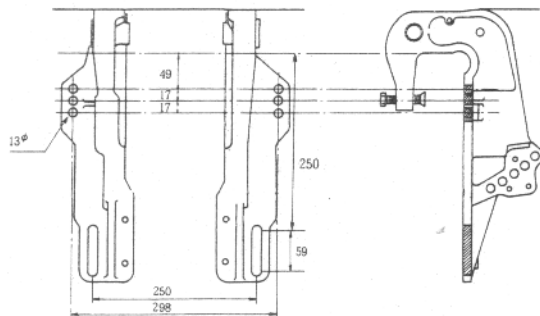

Fig. 4 Bracket bolt hole dimension (m/m)

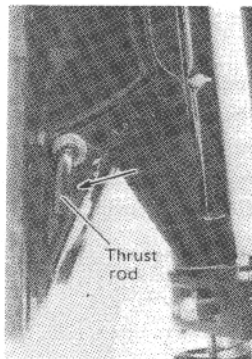

Photo. 1

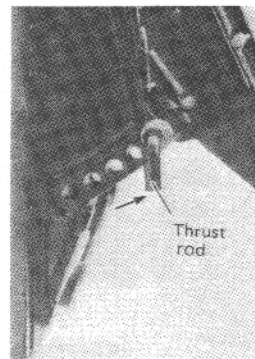

Photo. 2

(5) Adjustment of trim tab

If the boat fails to run straight, make adjustments using the trim tab installed under the anti-cavitation plate.

If the boat tends to veer to the left, move the trim tab slightly to the left by loosening the center bolt. Determine the optimum angle by trial and error.

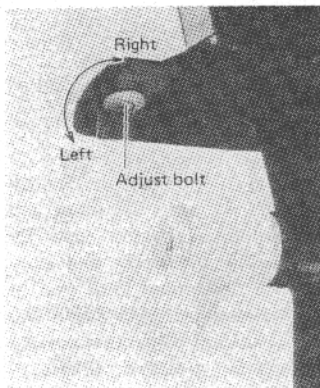

Photo. 3 Trim tab

(6) Steering connection kit

The drag link parts as shown in the diagram on the right, are available (P type). Moreover, the spacer may be required depending on the maker.

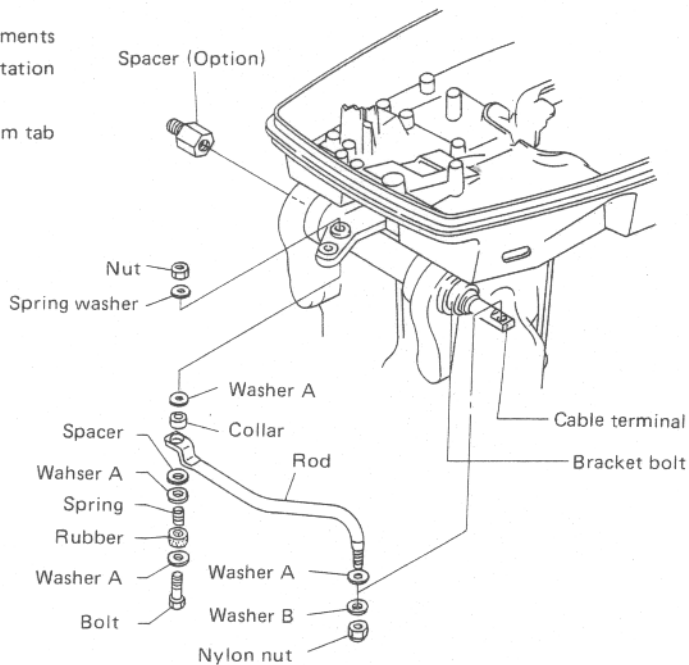

Fig. 6 Fitting the drag link

4. The Method of Connecting the Remote Control Cables (On the Remote Control Box Side)

Remote control box

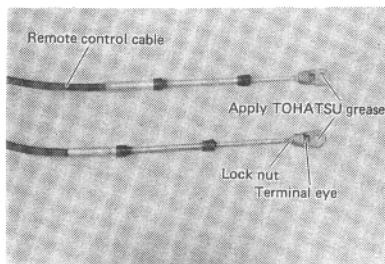

Photo. 4

- (1) Screw the terminal eyes provided into the thread portion at the tip of the remote control cable by approx. 11mm and fix with lock nuts. In this case make sure that the TOHATSU GREASE is applied to the attaching hole at the tip of the terminal eye. (Photo. 4)

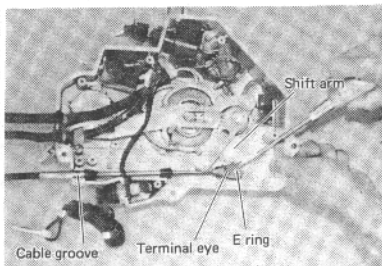

Photo. 5

- (2) Insert the remote control cables for shift use in the pin portion at the tip of the shift arm and fix the terminal eyes with E rings provided. Insert the tip of the remote control cables for throttle use in the throttle arm pin portion as remote control cable for shift use (Photo.5) and fix with E rings.

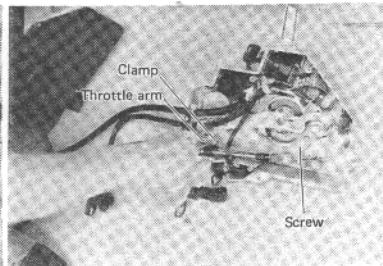

Photo 6

- (3) Position the remote control cable for shift use lower and the remote control cable for throttle use upper and coincide the groove with that of the attached cable clamp and fix them using screws and washers provided. (Photo.6) Fit the back plate using 5 screws.

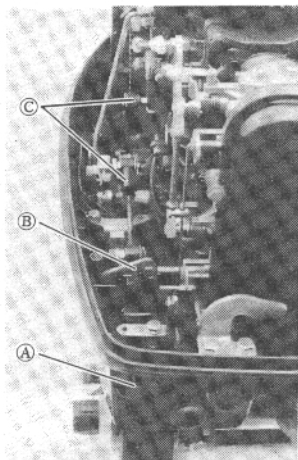

Photo. 7

- (1) Remove the upper cover from the motor.
Remove the grommet (A), cable clip (B) and cable joints (C) from the lower portion of the motor cover.

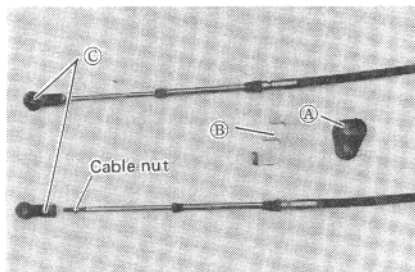

Photo. 8

- (2) Upper ... Throttle cable
Lower ... Clutch cable
Screw in the cable joint into the top end of the remote control cable (about 15mm). Lock the cable joint with a cable nut so that it will not work loose. (Photo 8)
- (3) Insert the cable into the motor cover from the front.
Attach the throttle cable to the advancer arm (D) and attach the clutch cable to the upper side of the clutch arm and fix them with clip pins. Insert the cable clip (B) into the cable outer groove and fix it to the lower

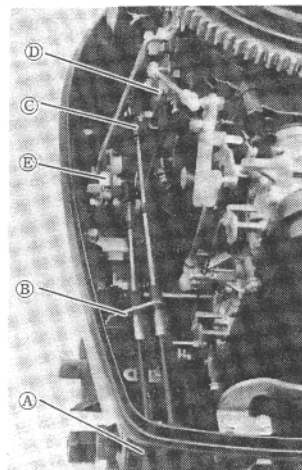

Photo. 9

- portion of the motor cover with a bolt and install the grommet (A). (Photo. 9)
After installing cables check that the free-accelerating lever and the clutch operate freely using the remote controls.

5. The Method of Wiring the Tachometer (Optional)

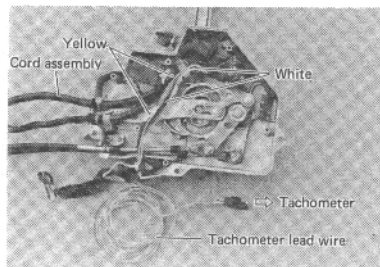

Photo. 10

The tachometer and lead wires are installed in the remote control box.

- Remove the back plate of the remote control box.
- Connect the white and yellow cords coming out of the B cord Assy with the white and yellow cords wires of the tachometer.
- Set the lead wires for tachometer on the safety switch and fix with the back plate of the remote control box.
- Insert the other side connector of the lead wire into the connector of the tachometer.
- The tachometer is installed on the dashboard or any other convenient location on the boat.

(Photo. 10)

6. MOUNTING THE BATTERY

- (1) Place the battery in the battery box and set the box in a part of the boat where it is protected from water spray. The box must be securely fastened so that it will not shake loose.

The capacity of the battery is 12V-70AH

- (2) Connect the (+) cord to the (+) battery terminal and then connect the (-) cord to the (-) terminal. (When detaching the cords, detach the (-) cord first.) The red cord is (+) cord. After connection be sure to place a terminal cover on the (+) terminal.

- Note:**
- (1) Use a battery cord having a sufficient length.
 - (2) Make sure that battery cords can not be caught between the motor and boat when turning, etc.
 - (3) If cords are incorrectly connected, the starter may fail to operate.
 - (4) Be sure to connect the (+) and (-) cords correctly. If they are connected, the charger will be damaged.
 - (5) Keep the battery fully charged at all times.

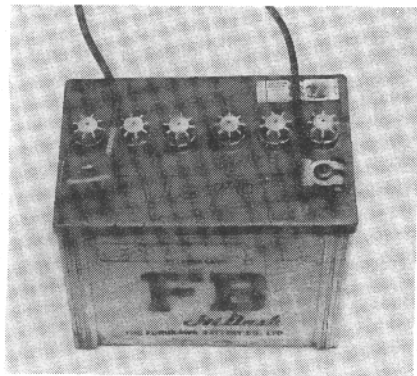

Photo. 11 Battery

7. PREPARATIONS BEFORE OPERATION AND PRECAUTIONS

Use TOHATSU genuine engine oil in the gasoline mixture. (Photo. 12)

(1) Fuel (Mixed oil and gasoline)

- (1) Fuel is a mixture of gasoline and Tohatsu genuine engine oil in the ratio 50 to 1.

A new outboard motor should be broken-in by running for a period of 10 hours with fuel of 20:1 mixing ratio (gasoline and engine oil).

- (2) When ordinary for 2 cycle engine oil is used, fuel should be mixed at the ratio of 20:1 and at 15:1 for the breaking-in period.
- (3) The use of poor quality gasoline and engine oil will shorten the life of the motor and also cause of poor starting and other troubles. Be sure to use high quality gasoline and Tohatsu genuine engine oil only.

- (4) Check that the tank contains a sufficient amount of fuel before starting for the day's operation. Always carry a spare tank (can) since running out of fuel at sea may result in a serious accident.

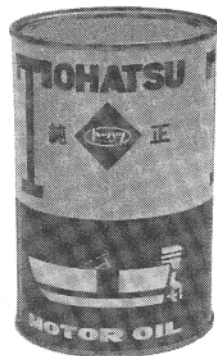

Photo. 12

8. STARTING THE MOTOR (P TYPE)

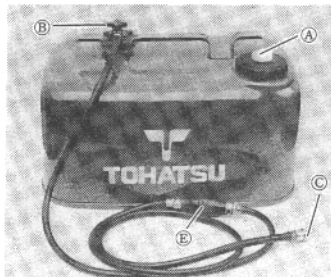

Photo. 13

- (1) Open the air vent screw (A) on the tank cap and open the fuel cock (B).

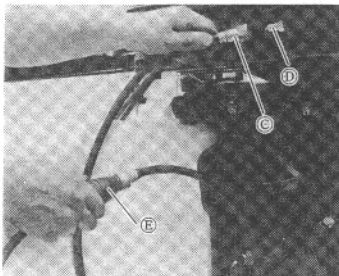

Photo. 14

- (2) Insert the fuel connector A (C) into the fuel connector B (D) at the lower portion of the motor cover.
Prime fuel into the carburetor by pumping the primer pump (E) until resistance is felt.

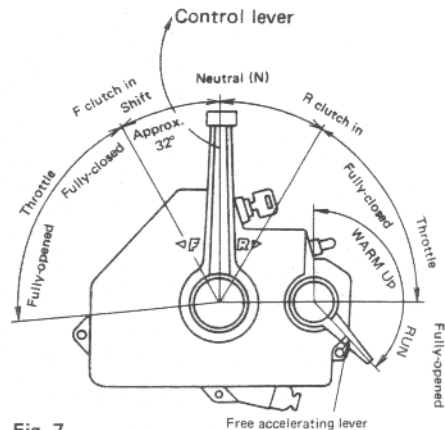

Fig. 7

- (3) Set the control lever in the remote control box to the neutral position (N).
Raise the free accelerating lever slightly upward.

This is a completely water-cooled engine. Cooling water is necessary even when it is being tested out of water.

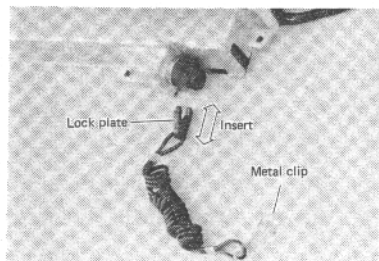

Photo. 15

(4) Safety Switch (Photo. 15)

Insert the lock plate into the safety switch.

- Note:** (1) As the lock plate is inserted, the starter motor can operate, but the engine cannot be started.
- (2) The engine will stop if the lock plate is pulled out while in operation.
- (3) The engine can be stopped by pushing the safety switch even when lock plate is inserted. (Push the safety switch until the engine stops.)

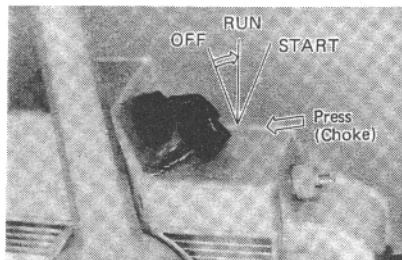

Photo. 16

(5) Main Switch (Photo. 16)

Insert the key into the main switch.

Turn the key to RUN position and push the key. Under this condition, the choke fully closes as the choke solenoid operates.

Turn the key to RUN and START positions with it is pressed to cause the engine to start.

If the engine is warm, turn the key to START position directly.

When the engine starts, let go of the key. It automatically returns to RUN position.

Note: If the starter is operated continuously for a long time, the life of the battery will be shortened. Operate the starter in a cycle of 3 seconds operation and 5 seconds pause.

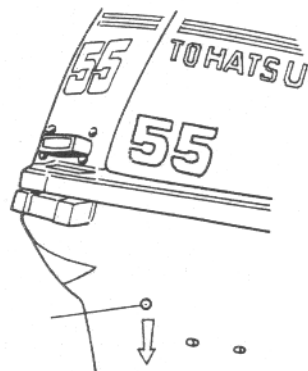

Fig. 8

- (6) When the engine starts, return the free accelerating lever down to the minimum slow speed position and check that cooling water is flowing through the cooling water checking port. Warm up the engine by running for 2 to 3 minutes.

(2) F type

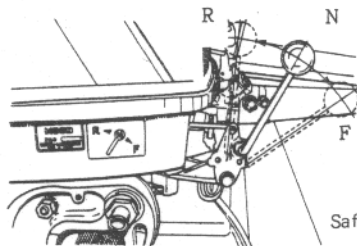

Fig. 9

- (1) Operate the engine in accordance with (1) and (2) step of P type engine.

Set the shift lever to N position.

Note: The engine can only be started when the shift lever is placed in the N position. (Neutral switch mechanism)

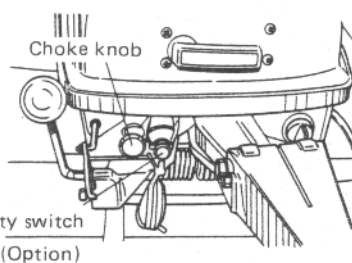

Fig. 10

- (2) Insert the lock plate into the safety switch.

- The engine cannot be started without the lock plate even if the starter motor rotates.
- Turn the grip of the bar handle to the position of START.
- Close the choke fully by pulling the choke knob all the way out. (This is not necessary if the engine is already warm.)

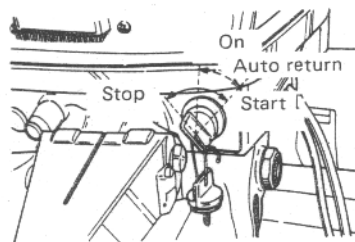

Fig. 11

- (3) Insert the key into the main switch and turn it to ON and START positions to turn over the engine.

- Operate the starter for 3 seconds of operation and then pause for 5 seconds until it fires.
- When the engine starts, let go of the key. (It automatically returns to ON position.)
- Push the choke knob back.
- Return the grip to a normal position and run the engine to warm up for several minutes.
- Confirm that cooling water is discharged from the port.

(3) Starting the engine when the starter is faulty

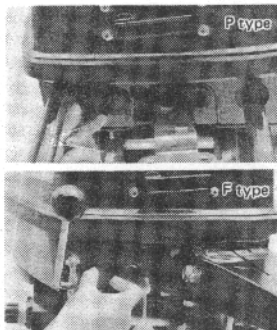

Photo. 17

- (1)
 - Confirm that the shift lever is in neutral position.
 - Confirm that the lock plate is inserted into the safety switch.
 - Insert the key into the main switch and turn to ON position.
 - Close the choke fully by pulling the choke knob. (This is not necessary if the engine is warm.)
 - Set the free accelerating lever (P type) or the throttle grip (F type) to a proper position (START).

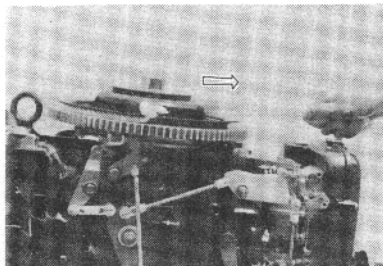

Photo. 18

- (2)
 - Remove the upper motor cover.
 - Wind the attached starting rope around the starter pulley of the flywheel clockwise and pull the rope vigorously start the engine.
 - Return the choke knob.
 - Return the throttle to SLOW side.

Note: When starting the engine with the rope, make sure that your clothes will not be caught by the engine,

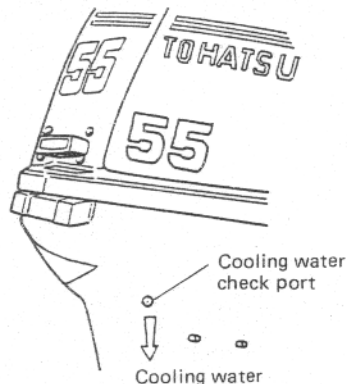

Fig. 12

- (3)
 - After the engine starts, replace the upper cover carefully.
 - Run the engine to warm up for 2 to 3 minutes.
 - Confirm that cooling water is discharging while the engine is running.

Note: After returning to port, have your starter motor checked and repaired, if necessary, by your dealer.



9. OPERATION



(1) Be sure to warm up the engine before running.

All parts of the engine should be uniformly warm before running so that lubricating all parts.

If this is neglected, the life of the engine will be considerably shortened.

(2) Be sure that cooling water is being discharged.

If the engine runs continuously without the circulation of cooling water, the engine may seize up due to overheating.

If cooling water is not being discharged, stop the engine and check the cooling water system.

(3) Do not idle the engine excessively.



If the engine runs for a long time in the neutral position, the engine may be damaged or it may cause excessive wear to the drive shaft or gear. Fuel will also be wasted.

(4) The running-in period is 10 hours and the fuel mixture is 20:1 (gasoline : Tohatsu oil)

- Careful running-in allows all sliding parts (pistons, cylinders, bearings, gears, etc.) to become a better fit each other and prevents uneven wear of those parts and results in a longer engine life.
- While running-in, the engine should be operated at about 80% of its normal speed. Avoid high speed operation.

(5) Forward and reverse

(1) P type remote control specifications (non-professional use)

Forward: When the control lever is moved in the forward direction at about the 32° position the clutch is engaged and the engine speed increases as the lever approaches the full forward position.

Reverse: When the control lever is moved in the reverse direction until it stops once the clutch is engaged and the engine speed increases to a lesser degree.

- Notes:**
- For both forward and reverse runnings confirm that the control lever is in neutral position and the engine runs at slow speed. Then quickly move the control lever in the required direction until the clutch is engaged.
 - The control lever does not operate until the free accelerating lever is returned to its fully closed (RUN) position).

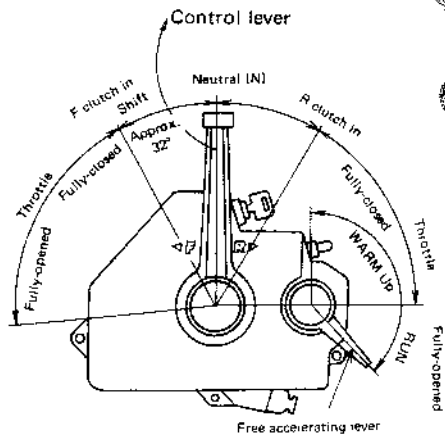

Fig. 13 Remote control operation

(2) F type bar handle specifications (commercial use)

- Return the handle grip to the slow speed position. After the engine has slowed down move the clutch lever into the F direction for forward running and sharply move it in the reverse direction for reverse running.
- When the shift lever is in N or R position the throttle is opened only by a small degree.
- Speed is controlled by the grip of the handle. (The engine runs faster as the grip is turned twisting.)
- The boat is steered by moving the bar handle to the left or to the right.

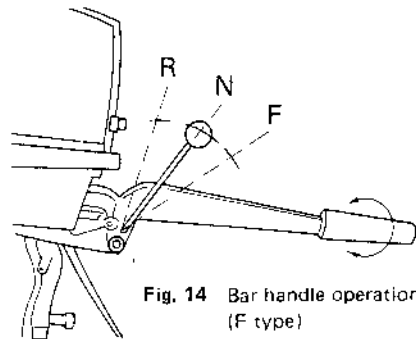

Fig. 14 Bar handle operation (F type)

(3) **The quick turning is dangerous. Make sure that turning is made at low speeds.**

- When reversing, run carefully by low speeds. Do not make the sudden acceleration. This causes water entering into the boat, and when collision occurs, it will have damage on a propeller and bracket or stern of boat.

(4) **Engine r.p.m.**

- When the engine r.p.m. is not within the left mentioned range during the full throttle operation, the propeller is not proper. Replace it with the proper one. (Refer to the following table).

Trolling	M55B & M70A	700~900r.p.m.
r.p.m. range at full throttle	M55B	4,500~5,500r.p.m.
	M70A	5,000~5,500r.p.m.

However, please note that the safety device (ESG) operates when the r.p.m. exceeds 5,600.

- The ESG (Electronic Safety Governor) and overspeed protection device are installed. The ESG prevents the over reduction which can be occurred when the motor jumps up from water.
- An overheat buzzer is installed in the remote control box (P type).

When the temperature of the engine cooling water rises abnormally this buzzer will be worked. Stop the engine immediately and check the cooling water inlet ports which are provided at the both sides of the gear case and at the lower portion of the cavitation plate. Remove the dust if necessary. Restart the engine after the engine temperature has fallen adequately. When the buzzer will be worked again even after the restarting please contact with your TOHATSU dealer.

(5) **List: Propellers**

Those propellers for which the transom height is not specified, are optional.

D : Outer diameter of the propeller (mm) P : Propeller pitch (mm)

Type D x P	Light load boat ←					→ Heavy load boat			
	(17.5) 276 x 447	(16.5) 273 x 417	(15) 280 x 381	(14) 289 x 356	(13) 292 x 330	(12) 295 x 305	(11) 292 x 279	(10) 292 x 254	(9) 305 x 229
M55B	○	○	○	○	L, LL	○	○	UL	○
M70A	○	○	○	L, LL	○	○	UL	○	○

(6) Stopping

- After running has been completed, run the engine for about 1 minute and then stop the engine.

(1) Stopping using the main switch (Photo. 20)

Turn the main switch on the lower motor cover or the remote control box to OFF. When the engine stops, remove the key from the main switch.

(2) Stopping using the safety switch (P type)

Pull out the lock plate of the safety switch on the remote control box or the safety switch on the lower motor cover (F). Or push the safety switch until the engine stops. (F type is optional specification.) After stopping the engine using the safety switch, be sure to turn the main switch to OFF and pull out the key.

- Note:**
- After the engine stops, remove the fuel connector.
 - When the outboard motor is not to be used for a long time, remove the cord from the battery (—) side first.

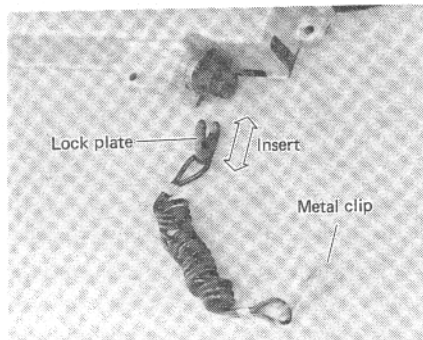

Photo. 19 Safety switch (P type)

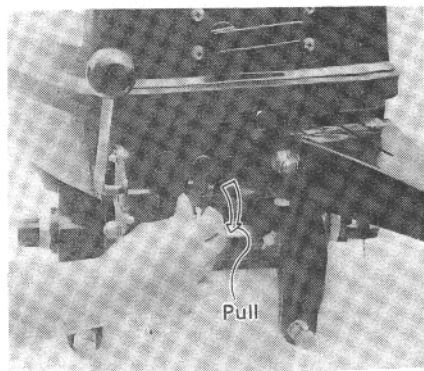

Photo. 20 Stopping the engine

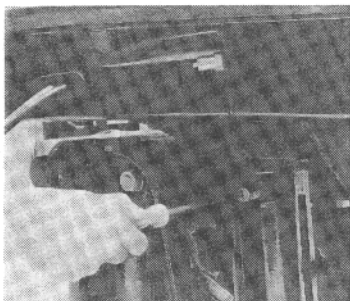

Photo. 21

(7) Adjustment of steering

(Photo. 21)

If the steering feels too "heavy" or too "light", the friction of the steering can be adjusted by the friction adjusting bolt.

To become lighter To become heavier

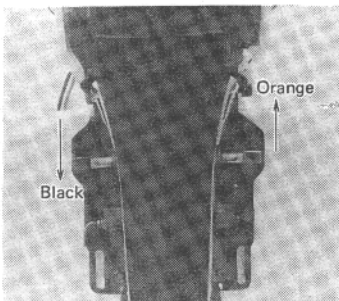

Photo. 22

(8) Tilt adjustment (EP, EF type)

(Photo. 22, Fig. 15)

- (1) Tilt-up
 - Black: Reverse lock lever
 - Orange: Tilt lever

Remove the mechanical steering system at a joint portion of outboard motor.
Move the reverse lock lever (black) downward.

Note: The method of operation is shown in the pink tag attached to the reverse lock lever.

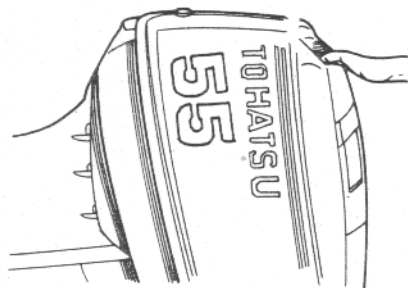

Fig. 15

Pull the motor fully inboard using the tilt handle at the back of the motor cover. The motor will be automatically tilt-locked.

- (2) To release
 - Move the tilt lever (orange) downward.
 - Pull the motor inboard once and then lower it slowly.
 - The reverse lock automatically returns and locks the motor in position.

(9) Inspection and adjustment

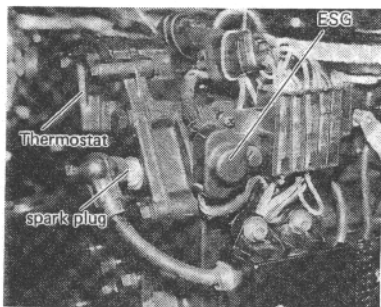

Photo. 23

(1) Thermostat (Photo. 23)

The engine is equipped with a thermostat to maintain the temperature of the engine at the correct value.

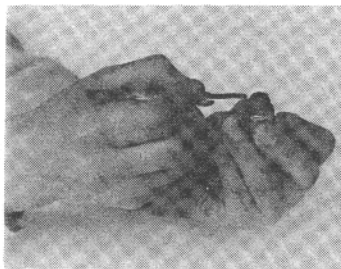

Photo. 24

(2) Spare plug (Photo. 24)

Clean the spark plug or replace if it is damaged. If the insulator portion of the plug is covered with dirt it will shorten the spark and the engine will not fire. Keep the plug clean at all times.

Too much fuel:

If the cylinder is flooded with fuel, the plug cannot ignite as it is wet with fuel. Wipe the plug and dry it. Remove excessive fuel from the cylinder by operating the starter motor in the fully open condition with the plug removed. After replacing the plug, the engine should start properly.

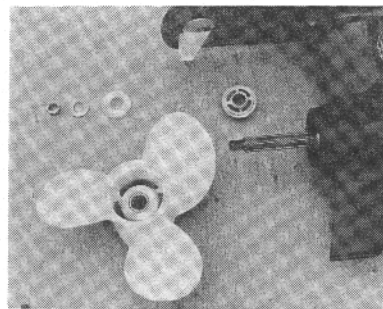

Photo. 25

(3) Propeller (Photo. 25)

If the propeller is worn or bent, the motor is not able to display its full performance or it may cause engine trouble. Replace the propeller if it is found to be damaged at the time of inspection.

Spark plug:

NGK B8HS10 or
CHAMPION L78C10
Plug gap: 1 mm



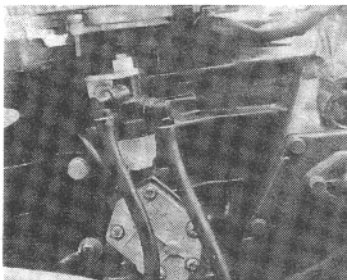

Photo. 26

(4) Fuel system

- Check the fuel tank to see that it contains sufficient fuel.
- Check that the air vent of the tank cap is clear.
- Check the squeeze pump bulb for cracks or damage.
- Check the fuel filter for dirt.

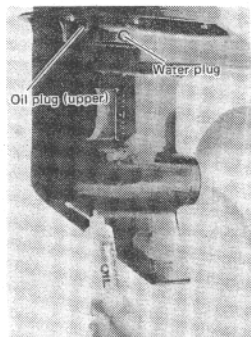

Photo. 27

(5) Changing gear oil

- Remove oil plugs (upper and lower) and drain gear oil completely.
- Insert the nozzle of an oil tube into the lower oil plug and inject oil by squeezing the tube until gear oil flows out of the upper plug.
- Tighten the upper oil plug and then remove the oil filler and tighten the lower oil plug.

Only use Tohatsu genuine gear oil (#80)

The amount of gear oil needed is about 900~930cc.

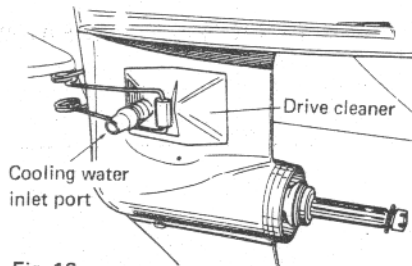

Fig. 16

(6) Washing with water

- After the motor has been operating in sea water or muddy water, wash the external parts and cooling water system with clean water.
- For washing, use a drive cleaner (option). Connect the drive cleaner to the water strainer cover on the gear case and connect it by hose to a water supply and flush out the cooling passages.
- If a water tank is used, a sufficiently large tank is needed so that the anti-cavitation plate of the motor is fully immersed. Wash the motor by allowing the engine to idle.
- In this case, the propeller should not rotate so set the clutch at N position.

10. INSPECTION AND REPAIRS

Use this check list to locate the source of trouble.

Consult your Tohatsu dealer for further information.

The engine fails to start.	The engine starts but soon stops.	Poor idling.	Poor acceleration.	The engine races.	The engine runs too slowly.	The engine does not pick up speed.	The engine overheats.	Possible cause
<input type="radio"/> <input type="radio"/> <input type="radio"/> <input type="radio"/> <input type="radio"/> <input type="radio"/> <input type="radio"/> <input type="radio"/> <input type="radio"/> <input type="radio"/>	<input type="radio"/> <input type="radio"/> <input type="radio"/> <input type="radio"/> <input type="radio"/> <input type="radio"/> <input type="radio"/> <input type="radio"/> <input type="radio"/> <input type="radio"/>	<input type="radio"/> <input type="radio"/> <input type="radio"/> <input type="radio"/> <input type="radio"/> <input type="radio"/> <input type="radio"/> <input type="radio"/> <input type="radio"/> <input type="radio"/>	<input type="radio"/> <input type="radio"/> <input type="radio"/> <input type="radio"/> <input type="radio"/> <input type="radio"/> <input type="radio"/> <input type="radio"/> <input type="radio"/> <input type="radio"/>	<input type="radio"/> <input type="radio"/> <input type="radio"/> <input type="radio"/> <input type="radio"/> <input type="radio"/> <input type="radio"/> <input type="radio"/> <input type="radio"/> <input type="radio"/>	<input type="radio"/> <input type="radio"/> <input type="radio"/> <input type="radio"/> <input type="radio"/> <input type="radio"/> <input type="radio"/> <input type="radio"/> <input type="radio"/> <input type="radio"/>	<input type="radio"/> <input type="radio"/> <input type="radio"/> <input type="radio"/> <input type="radio"/> <input type="radio"/> <input type="radio"/> <input type="radio"/> <input type="radio"/> <input type="radio"/>	<input type="radio"/> <input type="radio"/> <input type="radio"/> <input type="radio"/> <input type="radio"/> <input type="radio"/> <input type="radio"/> <input type="radio"/> <input type="radio"/> <input type="radio"/>	<p>Fuel tank empty.</p> <p>Fuel system incorrectly connected.</p> <p>Air leak in fuel system.</p> <p>Fuel pipe is twisted.</p> <p>Fuel cock of fuel tank and air vent of fuel cap are closed.</p> <p>Fuel filter, fuel connector and carburetor are clogged with dirt.</p> <p>Unsuitable engine oil.</p> <p>Unsuitable gasoline.</p> <p>Too much oil in mixed fuel mixture.</p> <p>Less oil in mixed fuel.</p>

	The engine fails to start.
<input type="radio"/> <input type="radio"/> <input type="radio"/> <input type="radio"/>	The engine starts but soon stops.
<input type="radio"/> <input type="radio"/>	Poor idling.
<input type="radio"/> <input type="radio"/> <input type="radio"/>	Poor acceleration.
<input type="radio"/> <input type="radio"/>	The engine races.
<input type="radio"/> <input type="radio"/>	The engine runs too slowly.
<input type="radio"/> <input type="radio"/>	The engine does not pick up speed.
<input type="radio"/> <input type="radio"/>	The engine overheats.
	Possible cause
<input type="radio"/> <input type="radio"/> <input type="radio"/> <input type="radio"/> <input type="radio"/>	<p>Cargo not properly loaded.</p> <p>Transom height too high or low.</p> <p>Lock plate of safety switch not inserted or short circuit or position of clutch N incorrect.</p> <p>Throttle link mechanism not properly adjusted.</p> <p>Ignition timing poorly adjusted.</p> <p>Battery is discharged, or blown fuse.</p>

11. PROCEDURE IF MOTOR FALLS INTO WATER

If the outboard motor dropped into water it must be immediately disassembled and oiled. If this is neglected or delayed, all parts of the engine may become rusty and corroded and may become unusable.

After taking emergency measures, have your engine repaired at your Tohatsu dealer as soon as possible.

Emergency procedures:

- (1) Remove the engine from water as soon as possible and wash sea water and mud from the engine with clean water.
- (2) Remove the spark plugs and remove water from the cylinders by turning the engine over by the starter rope.
- (3) After discharging water, inject Tohatsu genuine engine oil into the cylinder through the spark plug holes and from the carburetor side and disperse the engine oil by turning the engine over again by starter rope.
- (4) After performing the above procedures, the engine may probably be started. It is recommended that the engine be completely disassembled and serviced by a service shop since its electrical parts and carburetor will have deteriorated as a result of immersion.

12. LAYING UP THE ENGINE

If the boat with an outboard motor mounted is moored for some time under conditions where the air temperature falls below 0°C, water in the cooling water pump may freeze and damage the pump impeller. To prevent water from freezing, the lower part of the motor is kept in the water or discharge water completely from the pump by turning crank shaft over when it is in the tilted position.

13. SEASONAL STORAGE OF THE OUTBOARD MOTOR

Be sure to clean the outboard motor before it is stored for a long period.

Before storing your outboard motor, consult your Tohatsu dealer for laying-up procedures.

- (1) Wash out the cooling water system and drain all water from the system. Wash the exterior of the motor with clean water thoroughly and wipe off excess water and wipe the metal parts with a piece of cloth soaked in oil.
- (2) Drain gasoline from the carburetor, fuel tank and fuel pump and clean.
- (3) Remove the spark plug, lubricate the engine and effect turning of the flywheel by pulling starter rope.
- (4) Coat the propeller shaft with grease.
- (5) Change oil in the gear case.
- (6) Grease sliding parts, bolts and nuts.
- (7) Mist all engine parts with an anti-corrosion agent such as WD-40 or equivalent.
- (8) Cover the outboard motor and store it in a cool dry place.

Battery

- a. Remove the battery from the motor (—) first.
- b. Remove corrosion, dirt and grease by washing the surface of the battery with warm clean water and wipe the battery case carefully with dry cloth.
- c. Coat grease or vaseline on the battery terminals with grease or vaseline.
- d. Fully charge the battery before storage. Charge the battery every other month while in storage and check the level of electrolyte. Charging current is less than 5A.
- e. Cover up the battery and store it in a dry place.
- f. When the battery is taken back into service again, charge it fully before use.

14. DAILY INSPECTION

Check the following items before leaving part.

Item of inspection	Point of inspection	Remedy
Fuel system	<ul style="list-style-type: none"> ○ Check the fuel tank level. Fuel mixture (Gasoline 50 parts: Tohatsu genuine oil 1 part) ○ Check fuel rubber pipe for leaks. ○ Check tank filter for dirt and water. 	<p>Add fuel.</p> <p>Repair or replace.</p>
Electrical system	<ul style="list-style-type: none"> ○ Check spark plug for damage, wear and bridging. NGK B8HS10 or CHAMPION L78C10 ○ Check wiring and cord for damage or breakage. ○ Check main switch normal operation. ○ Check the operation of safety switch and lock plate. ○ Check starter pinion for wear and operation. ○ Check battery electrolyte level. ○ Check battery cords for proper connections. ○ Check terminals for looseness. 	<p>Clean or replace.</p> <p>Correct or replace.</p> <p>"</p> <p>"</p> <p>"</p> <p>Add electrolyte or charge</p> <p>Tighten, correct, replace.</p>
Throttle system	<ul style="list-style-type: none"> ○ Remote control (P): Check magneto for normal operation. ○ Check link system for play. ○ Check choke valve for normal operation. 	<p>Correct if necessary.</p> <p>Adjust.</p>
Clutch and propeller system	<ul style="list-style-type: none"> ○ Remote control (P): Check clutch system for normal engagement by shift lever (F). ○ Check propeller for damage or wear. ○ Check propeller nut for tightness. Check that split pins are in place. 	<p>Adjust.</p> <p>Replace.</p> <p>Adjust or replace.</p>

Item of inspection	Point of inspection	Remedy
Other points	<ul style="list-style-type: none"> ○ Check anode for corrosion or deformation. ○ Check clamp of the motor for tightness. ○ Check auxiliary rope for properly connection. ○ Check steering for proper friction. 	Replace . Tighten .
	<ul style="list-style-type: none"> ○ Check cooling water for circulation. ○ Check reverse lock action. 	Stop engine . Inspect and correct .

15. POWER TRIM AND TILT (OPTIONAL)

The power trim and tilt is designed to carry out the tilt up and down operations through the oil pressure. The trim angle (an angle of the outboard motor against the boat) can be adjusted depending on the condition of the wave and cargo, thus ensuring a best cruising condition. The result is improved fuel-efficiency and stable cruising plus shallow water running capability. Moreover, when using the shallow water running capability. Moreover, when using the remote control (P type) the power trim and switch can be operated at the grip portion of the control lever.

(1) Tilt up and down

- P type:
- Set the main switch of the remote control box at its "RUN" position.
 - Push the "UP" (up) side of the switch fitted to the grip for the control lever of the remote control box and the engine will be moved into the tilt up position. To carry out the tilt down push its "DN" (down) side referring to the diagram on the right.
 - The switch is automatically returned to its original position when released.
- F type:
- Set the main switch at its "ON" (running) position.
 - Turn the switch lever of the switch panel to the "UP" (up) side and the engine will be moved into its tilt up position and when turned to its "DN" (down) side the tilt down will be carried out.
 - When released the switch lever will be automatically returned to its original position.
 - The maximum tilt up and down positions are recognized as the motor sound changes while the switch is continuously pushed.

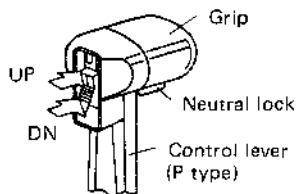

Fig. 17

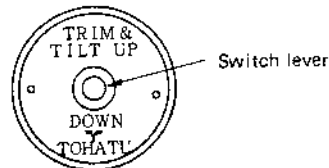

Fig. 18

- (Notes)**
- 1 When carrying out either a tilt up or a tilt down operation for mooring or similar purposes be sure to operate the switch after the engine has been stopped.
 - 2 When the trim is operated under overload conditions or the power trim and tilt switch is continuously pressed too long after either a tilt up or a tilt down operation has been completed, the breaker is tripped and the motor is stopped. (When continuously pressed under these conditions for over 30 seconds the breaker is tripped.)
The breaker is automatically reset approximately 10 to 20 seconds later. However, be sure to wait about 3 minutes before restarting the motor so as to enhance its durability when using it continuously.

(2) Power trim operation

The adjustment of the trim angle during cruising shall be carried out referring to the following.

- In case the bow (A) rides high, correct by pressing the DN (down) side of the switch or turning the switch lever to the "DN" side as the bow will tend to vibrate and cause unstable cruising. Note that the boat may capsize if the bow lifts too high out of the water.
- In case the bow (B) rides low correct by pressing the UP (up) side of the switch or turning the switch lever to the UP (up) side or else the water resistance will increase and the boat will take in water.

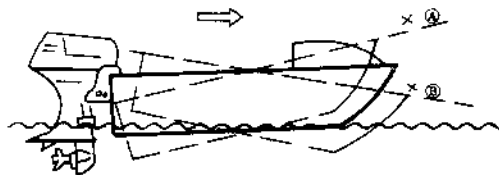

Fig. 19

(3) Shallow water cruising

Operate the engine at a speed which does not cause cavitation of propeller or with the angle suitable for shallow water cruising.

Note that it is very dangerous to operate the engine at a high speed.

(*The formation of cavity between the downstream surface of a moving body and a liquid normally in contact with it, as for example, behind the blades of a propeller which approach the water-level or are exposed to the air.)

(Note) Be sure to confirm through the water detection hole that the cooling water flows normally. If not, adjust by tilting down slightly.

(4) Manual operation

When requiring to carry out tilt up and down operations manually due to the shortage of the battery capacity or troubles of the power trim and tilt, please refer to the following. (Also refer to the warning name plate.) Open the manual release valve (the bottom of the case is marked with "M. VALVE") at the lower portion of the power unit by turning it a turn counterclockwise with a screwdriver. This allows the tilt up and down operations to be carried out manually. Be sure to close the valve by turning it clockwise until it does not turn any more, after manual operations.

(Note: When opening the manual release valve do not turn it more than 2 turns.)

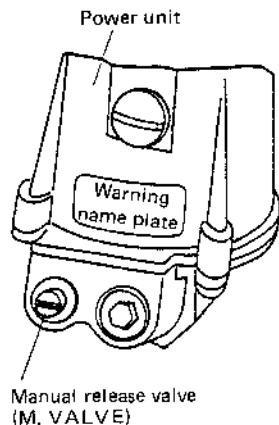

Fig. 20

(5) Checking of oil level in the power unit and method of topping up oil

- Inspection of the oil level

The oil level is inspected visually setting the outboard motor in the tilt down position so that the power unit is in horizontal.

Remove the oil plug by turning counterclockwise and check the oil level through the hole. It is sufficient if the level of the oil is full up to the lower plug hole. (Fig. 21)

- Recommended oil

MOBIL ATF 220

ESSO Automatic Transmission Fluid

SHELL Dexron II

Note: When air is mixed with the oil, it may affect the normal tilt up and down operation. In such case, take the following measures.

- Remove the oil plug.
- Tilt up the engine operating the PTT switch, open the manual release valve (one turn to left) and then down the engine by hand.
- Close the manual release valve (turn to right) and tilt up the engine again in the same manner operating the PTT switch.
- Repeat the same tilt up and down operation more than 4 times.

Remarks:

- When the down speed is too fast at the time of the hand operation, oil will come out. In such a case, adjust the tightening speed of the manual release valve properly.
- When the adjustment is finished, tighten the manual release valve completely.

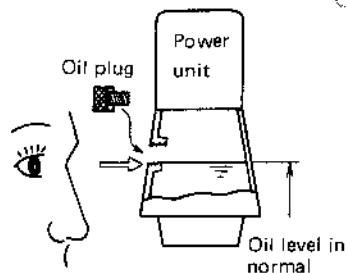

Fig. 21 Inspection of the oil level in the power unit

(6) Other matters

- (1) As there is a heavy drain on the battery please use 12V 70AH battery and keep it in a well-charged state.
- (2) Ensure that wires are correctly connected and that they are located in locations where they cannot be damaged or disconnected accidentally by passengers or cargo.
- (3) Take care that the power unit and piping of the power trim and tilt are not damaged accidentally.
- (4) When adjusting the power trim angle (the angle of the outboard engine to the boat) use the EPT type trim meter. One scale unit corresponds one step of the thrust rod.

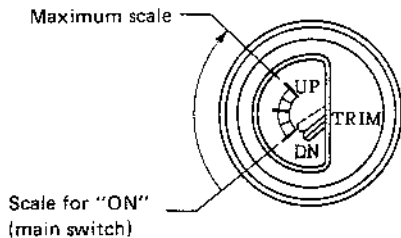

Fig. 22 Trim meter

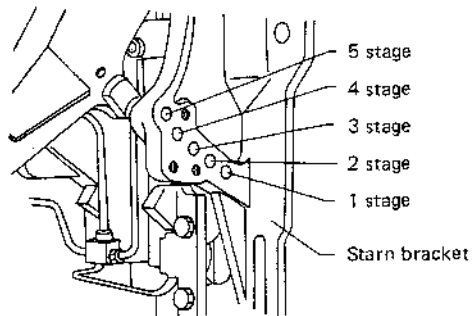

Fig. 23 Trim angle

16. PERIODICAL INSPECTION

- The frequency of periodical inspection of an outboard motor depends on usage. Please consult with your Tohatsu dealer for best inspection frequency for your motor.

Inspection item	Inspection frequency							Inspection points
	10 hrs or twice monthly	30 hrs or monthly	50 hrs or every 3 months	100 hrs or twice annually	1 year	1 and a half year	2 years	
Tightening bolts and nuts	○	○	○		○			Cylinder head • Exhaust cover • Carburetor • Inlet manifold • Starter mounting bolts and nuts
Fuel system		○	○	○	○	○	○	Carburetor • Fuel filter • Pipings • Tank, etc.
Electrical system		○		○	○	○	○	Spark plug • Ignition timing • Wiring • Starter motor • Battery, etc.
Cooling water system		○		○	○		○	Water pump • Thermostat
Gear oil	○		○	○	○	○	○	Change oil about 900cc~930cc.
Grease-up		○	○	○	○	○	○	Sliding parts • Revolving parts • Grease nipples

* Reassembled engine should be treated as a new engine.

17. CARE OF BATTERY

- (1) Keep the amount of electrolyte at the specified level and confirm that the battery is fully charged.
- (2) Fix the battery to the boat securely.
- (3) Connect cords to the battery securely and prevent them from being trapped by the motor during operation. Protect leads against damage. Apply grease to the battery terminals to prevent corrosion.
- (4) Do not operate the starter motor continuously. Use it intermittently for 3 seconds of operation and then wait 5 seconds.
- (5) Keep the battery clean at all times.
- (6) Be sure to fully charge the battery before storing it. Also charge it fully before it is used again. Store in a dry place.
- (7) Inspection procedures

Inspection point	Inspection period	Inspection procedures	Remarks
Capacity of battery	Every 3 months	Measure the specific gravity of electrolyte with a hydrometer. If it is more than 1.23 at 20°C in temperature, it is good. If it is lower than that, charge the battery. Overdischarge should be avoided.	12 V - 70 AH
Amount of electrolyte	After use	Check the level of electrolyte. Add distilled water to bring it up to the correct level if necessary.	

18. ACCESSORIES SUPPLIED

Name	Quantity
(1) Tools	
• Tool bag	1
• Socket wrench (21mm)	1
• Socket wrench handle	1
• Pliers (6")	1
• Screw driver (+)	1
• Screw driver (-)	1
• Spanner (17 x 19)	1
(2) Spare Parts	
• Starter rope (6 ϕ x 1000)	1
• Spark plug (NGK 88HS10)	1
• Split pin (P325)	1
(3) Parts for mounting bracket on a boat	
• Bolt (M12)	4
• Nut (M12)	4
• Plain washer A	4
• Plain washer B	4
(4) Fuel tank	
• Portable (Remote) 24 l tank with primer bulb assembly	1

19. OPTIONAL EQUIPMENT

Your Tohatsu dealer can give you further information.

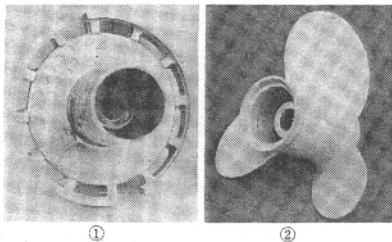

Photo. 28

- (1) Test Propeller
- (2) Propeller

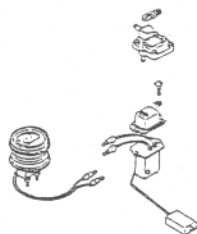

Fig. 24

Fuel meter

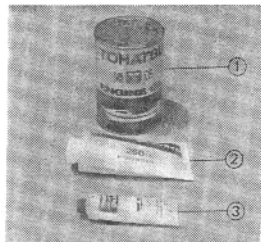

Photo. 29

- (1) Genuine engine oil
- (2) Gear oil
- (3) Grease

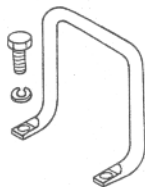

Fig. 25

Tilt handlebar

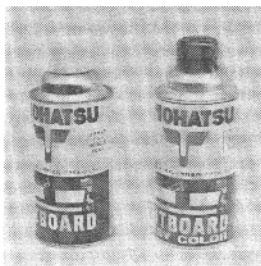

Photo. 30

Touch-up paint
(metallic blue, blue)

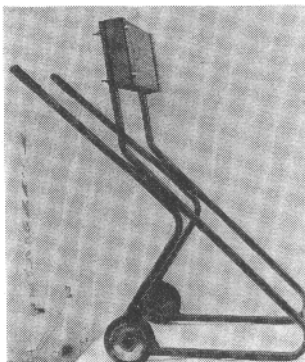

Photo. 31

Work stand

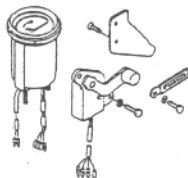

Fig. 26

Trimmer

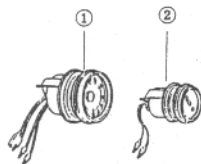

Fig. 27

- ① Tachometer
- ② Hourmeter

Other optional equipment:

Mechanical Steering Kit, Remote Control Kit for twin motor operation, Remote Control Cable (2m—6m), Remote Control Box, Tohatsu Genuine Engine Oil (20 L), etc. are available.

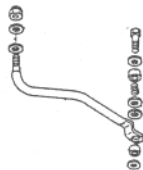

Fig. 28

Drag link kit

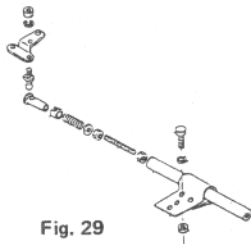

Fig. 29

Turn buckle for
twin lever remote
control

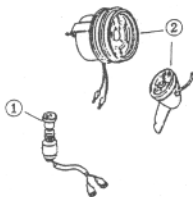

Fig. 30

- ① Meter lamp switch
- ② Speedometer

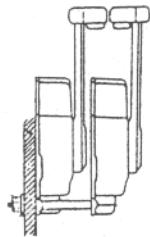
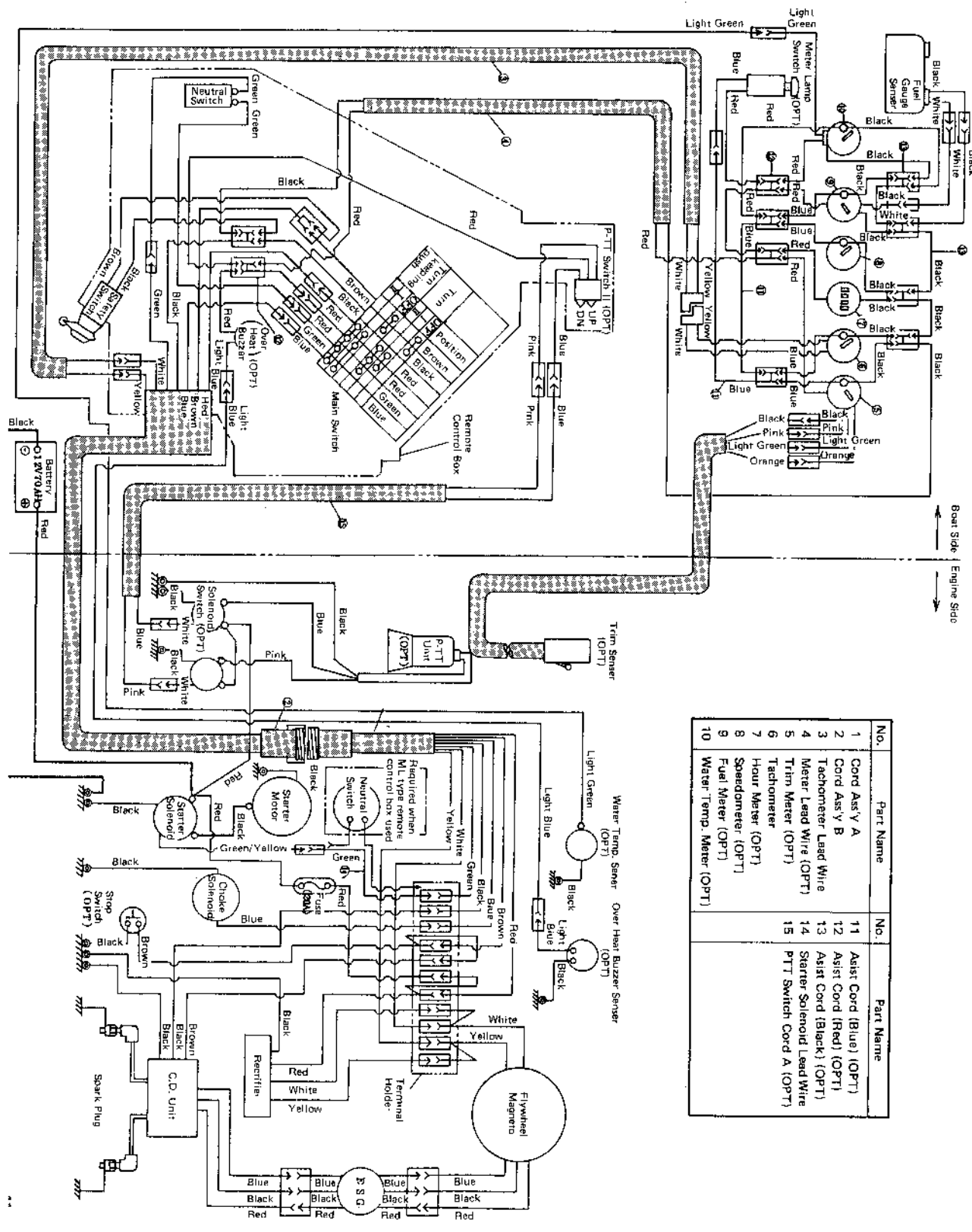

Fig. 31

Twin lever remote
control kit



No.	Part Name	No.	Part Name
1	Cord Asy A	11	Asist Cord (Blue) (OPT)
2	Cord Asy B	12	Asist Cord (Red) (OPT)
3	Tachometer Lead Wire	13	Asist Cord (Black) (OPT)
4	Meter Lead Wire (OPT)	14	Starter Solenoid Lead Wire
5	Trim Meter (OPT)	15	P-T-T Switch Cord A (OPT)
6	Tachometer		
7	Hour Meter (OPT)		
8	Speedometer (OPT)		
9	Fuel Meter (OPT)		
10	Water Temp. Meter (OPT)		